

UVK

Miniature Sized

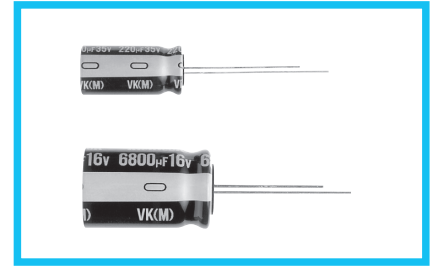

- One rank smaller case sizes than UVR.
- Compliant to the RoHS directive (2011/65/EU,(EU)2015/863).

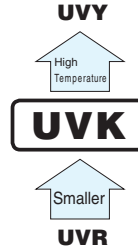

Specifications

Item	Performance Characteristics	
Category Temperature Range	-40 to +85°C (6.3V to 400V), -25°C to +85°C (450V)	
Rated Voltage Range	6.3 to 450V	
Rated Capacitance Range	22 to 22000µF	
Capacitance Tolerance	±20% at 120Hz, 20°C	
Leakage Current ※	Rated voltage (V)	6.3 to 100V
		160 to 450V
Tangent of loss angle (tan δ)	After 1 minute's application of rated voltage at 20°C, leakage current is not more than 0.03CV(µA). After 2 minutes' application of rated voltage at 20°C, leakage current is not more than 0.01CV(µA).	
	After 1 minute's application of rated voltage at 20°C, CV ≤ 1000 : I = 0.1CV+40µA or less CV>1000 : I = 0.04CV+100 (µA) or less	
Stability at Low Temperature	For capacitance of more than 1000µF, add 0.02 for every increase of 1000µF. Measurement frequency : 120Hz at 20°C	
	Rated voltage (V)	6.3 10 16 25 35 50 63 100 160 to 250 350 to 450
Endurance	Impedance ratio	Z(-25°C) / Z(+20°C) 5 4 3 2 2 2 3 4 6 15
	tan δ (max.)	Z(-40°C) / Z(+20°C) 12 10 8 5 4 3 4 8 10 —
Shelf Life	Capacitance change	Within ±20% of the initial capacitance value
	tan δ	200% or less than the initial specified value
Marking	Leakage current	Less than or equal to the initial specified value
	The specifications listed at right shall be met when the capacitors are restored to 20°C after the rated voltage is applied for 2000 hours at 85°C.	
After storing the capacitors under no load at 85°C for 1000 hours and then performing voltage treatment based on JIS C 5101-4 clause 4.1 at 20°C, they shall meet the specified values for the endurance characteristics listed above.		
Printed with white color letter on black sleeve.		

※ I : Leakage Current (µA), C : Rated Capacitance (µF), V : Rated Voltage (V)

Radial Lead Type

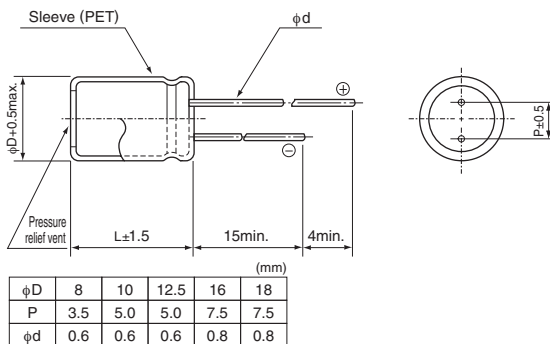

- Please refer to the Guidelines for Aluminum Electrolytic Capacitors for end seal configuration information.

Type numbering system (Example : 10V 3300µF)

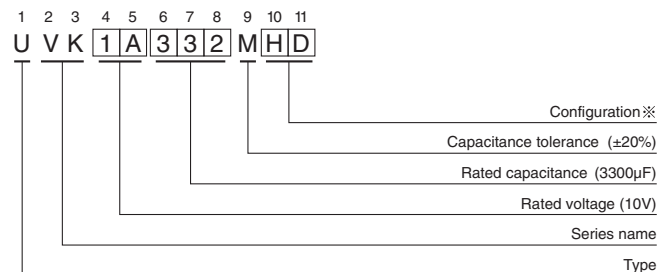

※ Configuration

φ D	Pb-free leadwire Pb-free PET sleeve
8 · 10	PD
12.5 to 18	HD

Frequency coefficient of rated ripple current

V	Cap.(µF)	Frequency				
		50Hz	120Hz	300Hz	1 kHz	10kHz or more
6.3 to 100	33 to 68	0.75	1.00	1.35	1.57	2.00
	100 to 470	0.80	1.00	1.23	1.34	1.50
	1000 to 22000	0.85	1.00	1.10	1.13	1.15
160 to 450	2.2 to 220	0.80	1.00	1.25	1.40	1.60
	330 to 470	0.90	1.00	1.10	1.13	1.15

● Dimension table in next page.

UVK

■ Dimensions

Rated Voltage (V) (code)	Rated Capacitance (μ F)	Case Size ϕ D \times L (mm)	tan δ	Leakage Current (μ A)		Rated Ripple (mArms) (85°C/120Hz)	Part Number
				at 20°C after 1 minute	at 20°C after 2 minutes		
6.3 (0J)	1000	8 \times 11.5	0.28	189	63	540	UVK0J102MPD
	2200	10 \times 16	0.30	415.8	138.6	890	UVK0J222MPD
	3300	10 \times 20	0.32	623.7	207.9	1190	UVK0J332MPD
	4700	12.5 \times 20	0.34	888.3	296.1	1550	UVK0J472MHD
	6800	12.5 \times 25	0.38	1285.2	428.4	1920	UVK0J682MHD
	10000	16 \times 25	0.46	1890	630	2350	UVK0J103MHD
	15000	16 \times 30.5	0.56	2835	945	2550	UVK0J153MHD
	22000	18 \times 35.5	0.70	4158	1386	3200	UVK0J223MHD
10 (1A)	1000	10 \times 12.5	0.24	300	100	650	UVK1A102MPD
	2200	10 \times 16	0.26	660	220	990	UVK1A222MPD
	3300	12.5 \times 20	0.28	990	330	1450	UVK1A332MHD
	4700	12.5 \times 25	0.30	1410	470	1800	UVK1A472MHD
	6800	16 \times 25	0.34	2040	680	2250	UVK1A682MHD
	10000	16 \times 30.5	0.42	3000	1000	2550	UVK1A103MHD
	15000	16 \times 35.5	0.52	4500	1500	2880	UVK1A153MHD
	22000	18 \times 40	0.66	6600	2200	3400	UVK1A223MHD
16 (1C)	470	8 \times 11.5	0.20	225.6	75.2	440	UVK1C471MPD
	1000	10 \times 12.5	0.20	480	160	700	UVK1C102MPD
	2200	10 \times 20	0.22	1056	352	1000	UVK1C222MPD
	3300	12.5 \times 25	0.24	1584	528	1700	UVK1C332MHD
	4700	16 \times 25	0.26	2256	752	2100	UVK1C472MHD
	6800	16 \times 25	0.30	3264	1088	2250	UVK1C682MHD
	10000	16 \times 35.5	0.38	4800	1600	2710	UVK1C103MHD
	15000	18 \times 40	0.48	7200	2400	3100	UVK1C153MHD
25 (1E)	330	8 \times 11.5	0.16	247.5	82.5	390	UVK1E331MPD
	470	10 \times 12.5	0.16	352.5	117.5	550	UVK1E471MPD
	1000	10 \times 16	0.16	750	250	860	UVK1E102MPD
	2200	12.5 \times 25	0.18	1650	550	1550	UVK1E222MHD
	3300	16 \times 25	0.20	2475	825	1980	UVK1E332MHD
	4700	16 \times 25	0.22	3525	1175	2200	UVK1E472MHD
	6800	16 \times 35.5	0.26	5100	1700	2600	UVK1E682MHD
	10000	18 \times 40	0.34	7500	2500	2800	UVK1E103MHD
35 (1V)	220	8 \times 11.5	0.14	231	77	350	UVK1V221MPD
	330	10 \times 12.5	0.14	346.5	115.5	490	UVK1V331MPD
	470	10 \times 16	0.14	493.5	164.5	650	UVK1V471MPD
	1000	12.5 \times 20	0.14	1050	350	1150	UVK1V102MHD
	2200	16 \times 25	0.16	2310	770	1800	UVK1V222MHD
	3300	16 \times 30.5	0.18	3465	1155	2100	UVK1V332MHD
	4700	16 \times 35.5	0.20	4935	1645	2500	UVK1V472MHD
	6800	18 \times 40	0.24	7140	2380	2800	UVK1V682MHD
50 (1H)	100	8 \times 11.5	0.12	150	50	260	UVK1H101MPD
	220	10 \times 12.5	0.12	330	110	430	UVK1H221MPD
	330	10 \times 16	0.12	495	165	590	UVK1H331MPD
	470	10 \times 20	0.12	705	235	760	UVK1H471MPD
	1000	12.5 \times 25	0.12	1500	500	1350	UVK1H102MHD
	2200	16 \times 30.5	0.14	3300	1100	1980	UVK1H222MHD
	3300	18 \times 35.5	0.16	4950	1650	2500	UVK1H332MHD

For cut leads, formed leads or taped parts, please add the appropriate code after the size code (12th digit).
If there is no size code in the part number, please add size code "1" and then add the appropriate code.

UVK

■ Dimensions

Rated Voltage (V) (code)	Rated Capacitance (μ F)	Case Size ϕ D \times L (mm)	tan δ	Leakage Current (μ A)		Rated Ripple (mA _{rms}) (85°C/120Hz)	Part Number
				at 20°C after 1 minute	at 20°C after 2 minutes		
63 (1J)	68	8 \times 11.5	0.10	128.52	42.84	220	UVK1J680MPD
	100	8 \times 11.5	0.10	189	63	280	UVK1J101MPD
	220	10 \times 16	0.10	415.8	138.6	490	UVK1J221MPD
	330	10 \times 20	0.10	623.7	207.9	710	UVK1J331MPD
	470	12.5 \times 20	0.10	888.3	296.1	900	UVK1J471MHD
	1000	16 \times 25	0.10	1890	630	1300	UVK1J102MHD
	2200	18 \times 35.5	0.12	4158	1386	2300	UVK1J222MHD
100 (2A)	33	8 \times 11.5	0.08	99	33	180	UVK2A330MPD
	47	8 \times 11.5	0.08	141	47	200	UVK2A470MPD
	68	10 \times 12.5	0.08	204	68	270	UVK2A680MPD
	100	10 \times 16	0.08	300	100	340	UVK2A101MPD
	220	12.5 \times 20	0.08	660	220	550	UVK2A221MHD
	330	12.5 \times 25	0.08	990	330	760	UVK2A331MHD
	470	16 \times 25	0.08	1410	470	1000	UVK2A471MHD
	1000	18 \times 35.5	0.08	3000	1000	1350	UVK2A102MHD
160 (2C)	10	8 \times 11.5	0.20	164	—	80	UVK2C100MPD
	22	10 \times 12.5	0.20	240.8	—	130	UVK2C220MPD
	33	10 \times 16	0.20	311.2	—	180	UVK2C330MPD
	47	10 \times 20	0.20	400.8	—	210	UVK2C470MPD
	68	12.5 \times 20	0.20	535.2	—	350	UVK2C680MHD
	100	12.5 \times 25	0.20	740	—	430	UVK2C101MHD
	220	16 \times 30.5	0.20	1508	—	580	UVK2C221MHD
	330	18 \times 35.5	0.20	2212	—	800	UVK2C331MHD
	470	18 \times 40	0.20	3108	—	1200	UVK2C471MHD
200 (2D)	10	8 \times 11.5	0.20	180	—	80	UVK2D100MPD
	22	10 \times 16	0.20	276	—	150	UVK2D220MPD
	33	10 \times 20	0.20	364	—	200	UVK2D330MPD
	47	12.5 \times 20	0.20	476	—	270	UVK2D470MHD
	68	12.5 \times 25	0.20	644	—	350	UVK2D680MHD
	100	16 \times 25	0.20	900	—	450	UVK2D101MHD
	220	16 \times 35.5	0.20	1860	—	700	UVK2D221MHD
	330	18 \times 40	0.20	2740	—	950	UVK2D331MHD
250 (2E)	10	10 \times 12.5	0.20	200	—	100	UVK2E100MPD
	22	10 \times 20	0.20	320	—	150	UVK2E220MPD
	33	10 \times 20	0.20	430	—	200	UVK2E330MPD
	47	12.5 \times 20	0.20	570	—	270	UVK2E470MHD
	68	16 \times 25	0.20	780	—	380	UVK2E680MHD
	100	16 \times 25	0.20	1100	—	440	UVK2E101MHD
	220	18 \times 35.5	0.20	2300	—	680	UVK2E221MHD

For cut leads, formed leads or taped parts, please add the appropriate code after the size code (12th digit).
If there is no size code in the part number, please add size code "1" and then add the appropriate code.

UVK

■ Dimensions

Rated Voltage (V) (code)	Rated Capacitance (μ F)	Case Size ϕ D \times L (mm)	tan δ	Leakage Current (μ A)		Rated Ripple (mArms) (85°C/120Hz)	Part Number
				at 20°C after 1 minute	at 20°C after 2 minutes		
350 (2V)	3.3	8 \times 11.5	0.25	146.2	—	43	UVK2V3R3MPD
	4.7	8 \times 11.5	0.25	165.8	—	55	UVK2V4R7MPD
	10	10 \times 12.5	0.25	240	—	90	UVK2V100MPD
	22	12.5 \times 20	0.25	408	—	150	UVK2V220MHD
	33	12.5 \times 25	0.25	562	—	240	UVK2V330MHD
	47	16 \times 25	0.25	758	—	300	UVK2V470MHD
	68	16 \times 25	0.25	1052	—	400	UVK2V680MHD
	100	18 \times 35.5	0.25	1500	—	520	UVK2V101MHD
400 (2G)	2.2	8 \times 11.5	0.25	128	—	38	UVK2G2R2MPD
	3.3	8 \times 11.5	0.25	152.8	—	48	UVK2G3R3MPD
	4.7	10 \times 12.5	0.25	175.2	—	60	UVK2G4R7MPD
	10	10 \times 16	0.25	260	—	90	UVK2G100MPD
	22	12.5 \times 25	0.25	452	—	200	UVK2G220MHD
	33	16 \times 25	0.25	628	—	240	UVK2G330MHD
	47	16 \times 25	0.25	852	—	280	UVK2G470MHD
	68	16 \times 30.5	0.25	1188	—	340	UVK2G680MHD
450 (2W)	100	18 \times 35.5	0.25	1700	—	440	UVK2G101MHD
	2.2	8 \times 11.5	0.25	139	—	28	UVK2W2R2MPD
	3.3	10 \times 12.5	0.25	159.4	—	40	UVK2W3R3MPD
	4.7	10 \times 12.5	0.25	184.6	—	46	UVK2W4R7MPD
	10	10 \times 20	0.25	280	—	80	UVK2W100MPD
	22	12.5 \times 25	0.25	496	—	140	UVK2W220MHD
	33	16 \times 25	0.25	694	—	180	UVK2W330MHD
	47	16 \times 30.5	0.25	946	—	220	UVK2W470MHD
	68	18 \times 35.5	0.25	1324	—	260	UVK2W680MHD
100	18 \times 40	0.25	1900	—	280	UVK2W101MHD	

For cut leads, formed leads or taped parts, please add the appropriate code after the size code (12th digit).
If there is no size code in the part number, please add size code "1" and then add the appropriate code.

- For formed lead or taped product specifications and minimum order quantity, please refer to the Guidelines for Aluminum Electrolytic Capacitors.

UVR

Miniature Sized

- Standard series for entertainment electronics.
- Compliant to the RoHS directive (2011/65/EU, (EU)2015/863).

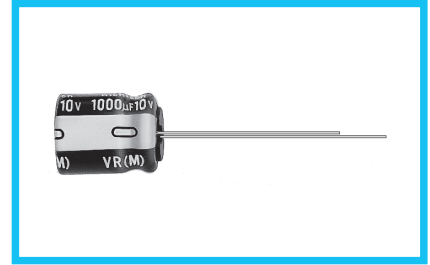
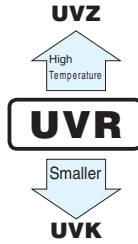

Specifications

Item	Performance Characteristics																																										
Category Temperature Range	-40 to +85°C (6.3V to 400V), -25 to +85°C (450V)																																										
Rated Voltage Range	6.3 to 450V																																										
Rated Capacitance Range	1 to 22000µF																																										
Capacitance Tolerance	±20% at 120Hz, 20°C																																										
Leakage Current ※	<table border="1"> <tr> <th>Rated voltage (V)</th> <th>6.3 to 100V</th> <th>160 to 450V</th> </tr> <tr> <td>_____</td> <td>After 1 minute's application of rated voltage at 20°C, leakage current is not more than 0.03CV(µA). After 2 minutes' application of rated voltage at 20°C, leakage current is not more than 0.01CV(µA).</td> <td>After 1 minute's application of rated voltage at 20°C, CV ≤ 1000 : I = 0.1CV+40µA or less CV > 1000 : I = 0.04CV+100 (µA) or less</td> </tr> </table>	Rated voltage (V)	6.3 to 100V	160 to 450V	_____	After 1 minute's application of rated voltage at 20°C, leakage current is not more than 0.03CV(µA). After 2 minutes' application of rated voltage at 20°C, leakage current is not more than 0.01CV(µA).	After 1 minute's application of rated voltage at 20°C, CV ≤ 1000 : I = 0.1CV+40µA or less CV > 1000 : I = 0.04CV+100 (µA) or less																																				
	Rated voltage (V)	6.3 to 100V	160 to 450V																																								
_____	After 1 minute's application of rated voltage at 20°C, leakage current is not more than 0.03CV(µA). After 2 minutes' application of rated voltage at 20°C, leakage current is not more than 0.01CV(µA).	After 1 minute's application of rated voltage at 20°C, CV ≤ 1000 : I = 0.1CV+40µA or less CV > 1000 : I = 0.04CV+100 (µA) or less																																									
Tangent of loss angle (tan δ)	For capacitance of more than 1000µF, add 0.02 for every increase of 1000µF. Measurement frequency : 120Hz at 20°C <table border="1"> <tr> <th>Rated voltage (V)</th> <th>6.3</th> <th>10</th> <th>16</th> <th>25</th> <th>35</th> <th>50</th> <th>63</th> <th>100</th> <th>160 to 315</th> <th>350 to 450</th> </tr> <tr> <td>tan δ (max.)</td> <td>0.28</td> <td>0.24</td> <td>0.20</td> <td>0.16</td> <td>0.14</td> <td>0.12</td> <td>0.10</td> <td>0.08</td> <td>0.20</td> <td>0.25</td> </tr> </table>	Rated voltage (V)	6.3	10	16	25	35	50	63	100	160 to 315	350 to 450	tan δ (max.)	0.28	0.24	0.20	0.16	0.14	0.12	0.10	0.08	0.20	0.25																				
Rated voltage (V)	6.3	10	16	25	35	50	63	100	160 to 315	350 to 450																																	
tan δ (max.)	0.28	0.24	0.20	0.16	0.14	0.12	0.10	0.08	0.20	0.25																																	
Stability at Low Temperature	<table border="1"> <tr> <th colspan="2">Rated voltage (V)</th> <th>6.3</th> <th>10</th> <th>16</th> <th>25</th> <th>35</th> <th>50</th> <th>63</th> <th>100</th> <th>160 to 200</th> <th>250 to 350</th> <th>400</th> <th>450</th> </tr> <tr> <td rowspan="2">Impedance ratio (max.)</td> <td>Z(-25°C) / Z(+20°C)</td> <td>5</td> <td>4</td> <td>3</td> <td>2</td> <td>2</td> <td>2</td> <td>2</td> <td>2</td> <td>3</td> <td>4</td> <td>6</td> <td>15</td> </tr> <tr> <td>Z(-40°C) / Z(+20°C)</td> <td>12</td> <td>10</td> <td>8</td> <td>5</td> <td>4</td> <td>3</td> <td>3</td> <td>3</td> <td>4</td> <td>8</td> <td>10</td> <td>—</td> </tr> </table>	Rated voltage (V)		6.3	10	16	25	35	50	63	100	160 to 200	250 to 350	400	450	Impedance ratio (max.)	Z(-25°C) / Z(+20°C)	5	4	3	2	2	2	2	2	3	4	6	15	Z(-40°C) / Z(+20°C)	12	10	8	5	4	3	3	3	4	8	10	—	Measurement frequency : 120Hz
	Rated voltage (V)		6.3	10	16	25	35	50	63	100	160 to 200	250 to 350	400	450																													
Impedance ratio (max.)	Z(-25°C) / Z(+20°C)	5	4	3	2	2	2	2	2	3	4	6	15																														
	Z(-40°C) / Z(+20°C)	12	10	8	5	4	3	3	3	4	8	10	—																														
Endurance	The specifications listed at right shall be met when the capacitors are restored to 20°C after the rated voltage is applied for 2000 hours at 85°C.	Capacitance change	Within ±20% of the initial capacitance value																																								
		tan δ	200% or less than the initial specified value																																								
		Leakage current	Less than or equal to the initial specified value																																								
Shelf Life	After storing the capacitors under no load at 85°C for 1000 hours and then performing voltage treatment based on JIS C 5101-4 clause 4.1 at 20°C, they shall meet the specified values for the endurance characteristics listed above.																																										
Marking	Printed with white color letter on black sleeve.																																										

※ I : Leakage Current (µA), C : Rated Capacitance (µF), V : Rated Voltage (V)

Radial Lead Type

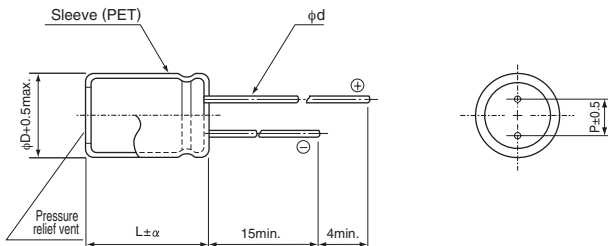

	(mm)				
φD	8	10	12.5	16	18
P	3.5	5.0	5.0	7.5	7.5
φd	0.6	0.6	0.6	0.8	0.8

α	(L < 20)	1.5
	(L ≥ 20)	2.0

- Please refer to the Guidelines for Aluminum Electrolytic Capacitors for end seal configuration information.

Frequency coefficient of rated ripple current

V	Cap.(µF)	Frequency				
		50Hz	120Hz	300Hz	1 kHz	10kHz or more
6.3 to 100	33 to 47	0.75	1.00	1.35	1.57	2.00
	100 to 470	0.80	1.00	1.23	1.34	1.50
	1000 to 22000	0.85	1.00	1.10	1.13	1.15
160 to 450	1 to 220	0.80	1.00	1.25	1.40	1.60
	330	0.90	1.00	1.10	1.13	1.15

Type numbering system (Example : 10V 3300µF)

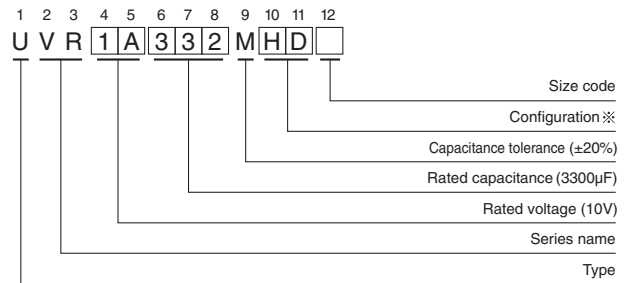

※ Configuration

φ D	Pb-free leadwire Pb-free PET sleeve
8 - 10	PD
12.5 to 18	HD

● Dimension table in next page.

UVR

■ Dimensions

Rated Voltage (V) (code)	Rated Capacitance (μF)	Case Size $\phi\text{D}\times\text{L}$ (mm)	$\tan \delta$	Leakage Current (μA)		Rated Ripple (mArms) (85°C/120Hz)	Part Number
				at 20°C after 1 minute	at 20°C after 2 minutes		
6.3 (0J)	1000	8×11.5	0.28	189	63	540	UVR0J102MPD
	2200	10×20	0.30	415.8	138.6	1000	UVR0J222MPD
	3300	10×20	0.32	623.7	207.9	1190	UVR0J332MPD
	4700	12.5×20	0.34	888.3	296.1	1550	UVR0J472MHD
	6800	12.5×25	0.38	1285.2	428.4	1920	UVR0J682MHD
	10000	16×25	0.46	1890	630	2350	UVR0J103MHD
	15000	16×35.5	0.56	2835	945	2850	UVR0J153MHD
	22000	18×40	0.70	4158	1386	3350	UVR0J223MHD
10 (1A)	1000	10×12.5	0.24	300	100	650	UVR1A102MPD
	2200	10×20	0.26	660	220	1100	UVR1A222MPD
	3300	12.5×20	0.28	990	330	1450	UVR1A332MHD
	4700	12.5×25	0.30	1410	470	1800	UVR1A472MHD
	6800	16×25	0.34	2040	680	2250	UVR1A682MHD
	10000	16×35.5	0.42	3000	1000	2700	UVR1A103MHD
	15000	18×35.5	0.52	4500	1500	3100	UVR1A153MHD
	22000	20×40	0.70	6600	2200	4350	UVR1A223MHD
16 (1C)	330	8×11.5	0.20	158.4	52.8	370	UVR1C331MPD
	470	8×11.5	0.20	225.6	75.2	440	UVR1C471MPD
	1000	10×16	0.20	480	160	790	UVR1C102MPD
	2200	12.5×20	0.22	1056	352	1300	UVR1C222MHD
	3300	12.5×25	0.24	1584	528	1700	UVR1C332MHD
	4700	16×25	0.26	2256	752	2100	UVR1C472MHD
	6800	16×35.5	0.30	3264	1088	2650	UVR1C682MHD
	10000	18×35.5	0.38	4800	1600	2950	UVR1C103MHD
25 (1E)	220	8×11.5	0.16	165	55	330	UVR1E221MPD
	330	10×12.5	0.16	247.5	82.5	440	UVR1E331MPD
	470	10×12.5	0.16	352.5	117.5	550	UVR1E471MPD
	1000	10×20	0.16	750	250	960	UVR1E102MPD
	2200	12.5×25	0.18	1650	550	1550	UVR1E222MHD
	3300	16×25	0.20	2475	825	1980	UVR1E332MHD
	4700	16×30.5	0.22	3525	1175	2450	UVR1E472MHD
	6800	18×35.5	0.26	5100	1700	2900	UVR1E682MHD
35 (1V)	220	10×12.5	0.14	231	77	385	UVR1V221MPD
	330	10×12.5	0.14	346.5	115.5	490	UVR1V331MPD
	470	10×16	0.14	493.5	164.5	650	UVR1V471MPD
	1000	12.5×20	0.14	1050	350	1150	UVR1V102MHD
	2200	16×25	0.16	2310	770	1800	UVR1V222MHD
	3300	16×35.5	0.18	3465	1155	2280	UVR1V332MHD
	4700	18×35.5	0.20	4935	1645	2700	UVR1V472MHD
	6800	20×40	0.26	6800	2200	3500	UVR1V682MHD

For cut leads, formed leads or taped parts, please add the appropriate code after the size code (12th digit).
If there is no size code in the part number, please add size code "1" and then add the appropriate code.

UVR

■ Dimensions

Rated Voltage (V) (code)	Rated Capacitance (μ F)	Case Size ϕ D \times L (mm)	tan δ	Leakage Current (μ A)		Rated Ripple (mA _{rms}) (85°C/120Hz)	Part Number
				at 20°C after 1 minute	at 20°C after 2 minutes		
50 (1H)	100	8 \times 11.5	0.12	150	50	260	UVR1H101MPD
	220	10 \times 12.5	0.12	330	110	430	UVR1H221MPD
	330	10 \times 16	0.12	495	165	590	UVR1H331MPD
	470	12.5 \times 20	0.12	705	235	760	UVR1H471MHD
	1000	12.5 \times 25	0.12	1500	500	1350	UVR1H102MHD
	2200	16 \times 35.5	0.14	3300	1100	2100	UVR1H222MHD
	3300	18 \times 35.5	0.16	4950	1650	2500	UVR1H332MHD
63 (1J)	100	10 \times 12.5	0.10	189	63	300	UVR1J101MPD
	220	10 \times 16	0.10	415.8	138.6	490	UVR1J221MPD
	330	10 \times 20	0.10	623.7	207.9	710	UVR1J331MPD
	470	12.5 \times 20	0.10	888.3	296.1	900	UVR1J471MHD
	1000	16 \times 25	0.10	1890	630	1300	UVR1J102MHD
	2200	18 \times 35.5	0.12	4158	1386	2300	UVR1J222MHD
100 (2A)	33	8 \times 11.5	0.08	99	33	180	UVR2A330MPD
	47	10 \times 12.5	0.08	141	47	230	UVR2A470MPD
	100	10 \times 20	0.08	300	100	370	UVR2A101MPD
	220	12.5 \times 25	0.08	660	220	620	UVR2A221MHD
	330	12.5 \times 25	0.08	990	330	760	UVR2A331MHD
	470	16 \times 25	0.08	1410	470	1000	UVR2A471MHD
	1000	18 \times 40	0.08	3000	1000	1380	UVR2A102MHD
160 (2C)	10	8 \times 11.5	0.20	164	—	80	UVR2C100MPD
	22	10 \times 16	0.20	240.8	—	155	UVR2C220MPD
	33	10 \times 20	0.20	311.2	—	205	UVR2C330MPD
	47	12.5 \times 20	0.20	400.8	—	270	UVR2C470MHD
	100	12.5 \times 25	0.20	740	—	430	UVR2C101MHD
	220	16 \times 35.5	0.20	1508	—	800	UVR2C221MHD
	330	18 \times 40	0.20	2212	—	940	UVR2C331MHD
200 (2D)	4.7	8 \times 11.5	0.20	134	—	55	UVR2D4R7MPD
	10	10 \times 12.5	0.20	180	—	95	UVR2D100MPD
	22	10 \times 20	0.20	276	—	170	UVR2D220MPD
	33	12.5 \times 20	0.20	364	—	230	UVR2D330MHD
	47	12.5 \times 20	0.20	476	—	270	UVR2D470MHD
	100	16 \times 30.5	0.20	900	—	530	UVR2D101MHD
	220	18 \times 35.5	0.20	1860	—	810	UVR2D221MHD
250 (2E)	3.3	8 \times 11.5	0.20	122.5	—	46	UVR2E3R3MPD
	4.7	8 \times 11.5	0.20	147	—	55	UVR2E4R7MPD
	10	10 \times 16	0.20	200	—	105	UVR2E100MPD
	22	12.5 \times 20	0.20	320	—	190	UVR2E220MHD
	33	12.5 \times 20	0.20	430	—	230	UVR2E330MHD
	47	12.5 \times 25	0.20	570	—	300	UVR2E470MHD
	100	16 \times 30.5	0.20	1100	—	520	UVR2E101MHD

For cut leads, formed leads or taped parts, please add the appropriate code after the size code (12th digit).
If there is no size code in the part number, please add size code "1" and then add the appropriate code.

UVR

■ Dimensions

Rated Voltage (V) (code)	Rated Capacitance (μF)	Case Size $\phi\text{D}\times\text{L}$ (mm)	tan δ	Leakage Current (μA)		Rated Ripple (mArms) (85°C/120Hz)	Part Number
				at 20°C after 1 minute	at 20°C after 2 minutes		
315 (2F)	2.2	8×11.5	0.20	109.3	—	33	UVR2F2R2MPD
	3.3	10×12.5	0.20	141.58	—	55	UVR2F3R3MPD
	4.7	10×12.5	0.20	159.22	—	65	UVR2F4R7MPD
	10	10×20	0.20	226	—	115	UVR2F100MPD
	22	12.5×20	0.20	377.2	—	190	UVR2F220MHD
	33	16×25	0.20	515.8	—	275	UVR2F330MHD
	47	16×25	0.20	692.2	—	340	UVR2F470MHD
350 (2V)	2.2	8×11.5	0.25	117	—	38	UVR2V2R2MPD
	3.3	10×12.5	0.25	146.2	—	55	UVR2V3R3MPD
	4.7	10×12.5	0.25	165.8	—	65	UVR2V4R7MPD
	10	10×20	0.25	240	—	115	UVR2V100MPD
	22	12.5×25	0.25	408	—	200	UVR2V220MHD
	33	16×25	0.25	562	—	275	UVR2V330MHD
	47	16×35.5	0.25	758	—	380	UVR2V470MHD
400 (2G)	1	8×11.5	0.25	80	—	25	UVR2G010MPD
	2.2	10×12.5	0.25	128	—	45	UVR2G2R2MPD
	3.3	10×12.5	0.25	152.8	—	55	UVR2G3R3MPD
	4.7	10×16	0.25	175.2	—	70	UVR2G4R7MPD
	10	12.5×20	0.25	260	—	130	UVR2G100MHD
	22	16×25	0.25	452	—	240	UVR2G220MHD
	33	16×30.5	0.25	628	—	300	UVR2G330MHD
450 (2W)	1	8×11.5	0.25	85	—	23	UVR2W010MPD
	2.2	10×12.5	0.25	139	—	35	UVR2W2R2MPD
	3.3	10×16	0.25	159.4	—	45	UVR2W3R3MPD
	4.7	10×20	0.25	184.6	—	55	UVR2W4R7MPD
	10	12.5×20	0.25	280	—	90	UVR2W100MHD
	22	16×25	0.25	496	—	165	UVR2W220MHD
	33	16×35.5	0.25	694	—	230	UVR2W330MHD
47	18×40	0.25	946	—	300	UVR2W470MHD	

For cut leads, formed leads or taped parts, please add the appropriate code after the size code (12th digit).
If there is no size code in the part number, please add size code "1" and then add the appropriate code.

- For formed lead or taped product specifications and minimum order quantity, please refer to the Guidelines for Aluminum Electrolytic Capacitors.

UVC

Ultra-Miniature-Sized for adapters.



- One rank smaller case sizes than UVY.
- Suited for adapter circuit.
- Compliant to the RoHS directive (2011/65/EU,(EU)2015/863).

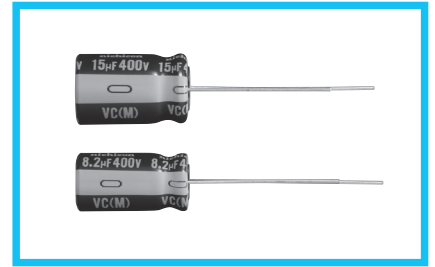
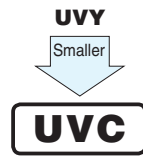

Specifications

Item	Performance Characteristics									
Category Temperature Range	-40 to +105°C									
Rated Voltage Range	400V									
Rated Capacitance Range	4.7 to 18µF									
Capacitance Tolerance	±20% at 120Hz, 20°C									
Leakage Current ※	After 1 minute's application of rated voltage at 20°C, I = 0.04CV+100 (µA) or less									
Tangent of loss angle (tan δ)	<table border="1"> <tr> <td>Rated voltage (V)</td> <td>400</td> <td rowspan="2">Measurement frequency : 120Hz, at 20°C</td> </tr> <tr> <td>tan δ (max.)</td> <td>0.25</td> </tr> </table>	Rated voltage (V)	400	Measurement frequency : 120Hz, at 20°C	tan δ (max.)	0.25				
Rated voltage (V)	400	Measurement frequency : 120Hz, at 20°C								
tan δ (max.)	0.25									
Stability at Low Temperature	<table border="1"> <tr> <td>Rated voltage (V)</td> <td>400</td> <td rowspan="3">Measurement frequency : 120Hz</td> </tr> <tr> <td>Impedance ratio</td> <td>Z(-25°C) / Z(+20°C)</td> <td>6</td> </tr> <tr> <td>(max.)</td> <td>Z(-40°C) / Z(+20°C)</td> <td>10</td> </tr> </table>	Rated voltage (V)	400	Measurement frequency : 120Hz	Impedance ratio	Z(-25°C) / Z(+20°C)	6	(max.)	Z(-40°C) / Z(+20°C)	10
Rated voltage (V)	400	Measurement frequency : 120Hz								
Impedance ratio	Z(-25°C) / Z(+20°C)		6							
(max.)	Z(-40°C) / Z(+20°C)		10							
Endurance	<p>The specifications listed at right shall be met when the capacitors are restored to 20°C after D.C. bias plus rated ripple current is applied for 2000 hours at 105°C, the peak voltage shall not exceed the rated voltage.</p> <table border="1"> <tr> <td>Capacitance change</td> <td>Within ±25% of the initial capacitance value</td> </tr> <tr> <td>tan δ</td> <td>200% or less than the initial specified value</td> </tr> <tr> <td>Leakage current</td> <td>Less than or equal to the initial specified value</td> </tr> </table>	Capacitance change	Within ±25% of the initial capacitance value	tan δ	200% or less than the initial specified value	Leakage current	Less than or equal to the initial specified value			
Capacitance change	Within ±25% of the initial capacitance value									
tan δ	200% or less than the initial specified value									
Leakage current	Less than or equal to the initial specified value									
Shelf Life	After storing the capacitors under no load at 105°C for 1000 hours and then performing voltage treatment based on JIS C 5101-4 clause 4.1 at 20°C, they shall meet the specified values for the endurance characteristics listed above.									
Marking	Printed with white color letter on dark brown sleeve.									

※ I : Leakage Current (µA), C : Rated Capacitance (µF), V : Rated Voltage (V)

Radial Lead Type

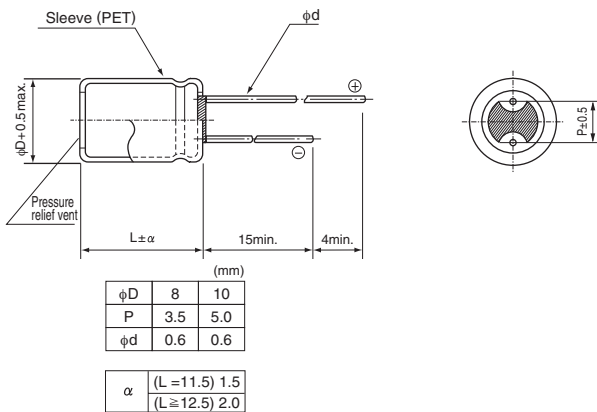

- Please refer to the Guidelines for Aluminum Electrolytic Capacitors for end seal configuration information.

Frequency coefficient of rated ripple current

Cap. (µF)	Frequency	50Hz	120Hz	500Hz	1 kHz	10kHz or more
4.7 to 8.2		0.65	1.00	1.20	1.30	1.50
10 to 18		0.80	1.00	1.20	1.30	1.50

Type numbering system (Example : 400V 15µF)

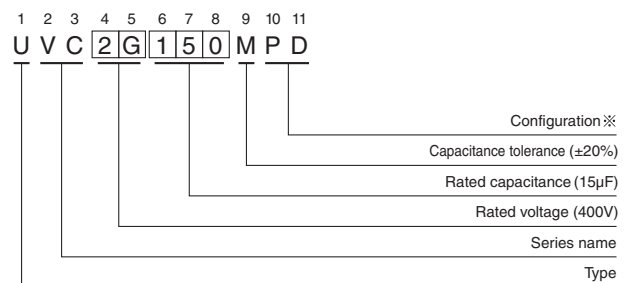

※ Configuration

φ D	Pb-free leadwire
8 · 10	Pb-free PET sleeve
	PD

● Dimension table in next page.



■ Dimensions

Rated Voltage (V) (code)	Rated Capacitance (μF)	Case Size φD×L (mm)	tan δ	Leakage Current (μA) (at 20°C after 1 minute)	Rated Ripple (mArms) (105°C/120Hz)	Part Number
400 (2G)	4.7	8×11.5	0.25	175.2	70	UVC2G4R7MPD
	5.6	8×11.5	0.25	189.6	70	UVC2G5R6MPD
	8.2	8×16	0.25	231.2	85	UVC2G8R2MPD
	10	10×12.5	0.25	260	100	UVC2G100MPD
	12	8×20	0.25	292	120	UVC2G120MPD
	15	10×16	0.25	340	150	UVC2G150MPD
	18	10×20	0.25	388	200	UVC2G180MPD

For cut leads, formed leads or taped parts, please add the appropriate code after the size code (12th digit).
If there is no size code in the part number, please add size code "1" and then add the appropriate code.

- For formed lead or taped product specifications and minimum order quantity, please refer to the Guidelines for Aluminum Electrolytic Capacitors.

UVY Wide Temperature Range

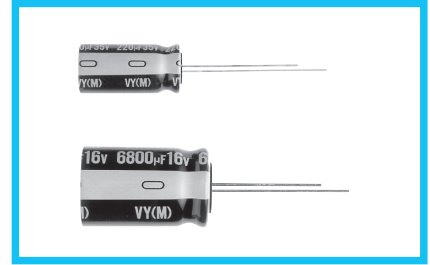
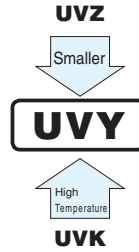

- One rank smaller case sizes than UVZ.
- Compliant to the RoHS directive (2011/65/EU, (EU)2015/863).

Specifications

Item	Performance Characteristics																																		
Category Temperature Range	-55 to +105°C (6.3 to 100V), -40 to +105°C (160 to 400V), -25 to +105°C (450V)																																		
Rated Voltage Range	6.3 to 450V																																		
Rated Capacitance Range	2.2 to 22000µF																																		
Capacitance Tolerance	±20% at 120Hz, 20°C																																		
Leakage Current ※	<table border="1"> <tr> <th>Rated voltage (V)</th> <th>6.3 to 100</th> <th>160 to 450</th> </tr> <tr> <td>After 1 minute's application of rated voltage at 20°C, leakage current is not more than 0.03CV(µA).</td> <td colspan="2"></td> </tr> <tr> <td>After 2 minutes' application of rated voltage at 20°C, leakage current is not more than 0.01CV(µA).</td> <td colspan="2"></td> </tr> </table>	Rated voltage (V)	6.3 to 100	160 to 450	After 1 minute's application of rated voltage at 20°C, leakage current is not more than 0.03CV(µA).			After 2 minutes' application of rated voltage at 20°C, leakage current is not more than 0.01CV(µA).																											
	Rated voltage (V)	6.3 to 100	160 to 450																																
After 1 minute's application of rated voltage at 20°C, leakage current is not more than 0.03CV(µA).																																			
After 2 minutes' application of rated voltage at 20°C, leakage current is not more than 0.01CV(µA).																																			
Tangent of loss angle (tan δ)	For capacitance of more than 1000µF, add 0.02 for every increase of 1000µF. Measurement frequency : 120Hz at 20°C <table border="1"> <tr> <th>Rated voltage (V)</th> <th>6.3</th> <th>10</th> <th>16</th> <th>25</th> <th>35</th> <th>50</th> <th>63</th> <th>100</th> <th>160 to 250</th> <th>350 to 450</th> </tr> <tr> <td>tan δ (max.)</td> <td>0.28</td> <td>0.24</td> <td>0.20</td> <td>0.16</td> <td>0.14</td> <td>0.12</td> <td>0.10</td> <td>0.08</td> <td>0.20</td> <td>0.25</td> </tr> </table>	Rated voltage (V)	6.3	10	16	25	35	50	63	100	160 to 250	350 to 450	tan δ (max.)	0.28	0.24	0.20	0.16	0.14	0.12	0.10	0.08	0.20	0.25												
Rated voltage (V)	6.3	10	16	25	35	50	63	100	160 to 250	350 to 450																									
tan δ (max.)	0.28	0.24	0.20	0.16	0.14	0.12	0.10	0.08	0.20	0.25																									
Stability at Low Temperature	Measurement frequency : 120Hz																																		
	<table border="1"> <tr> <th colspan="2">Rated voltage (V)</th> <th>6.3</th> <th>10</th> <th>16</th> <th>25</th> <th>35 to 50</th> <th>63 to 100</th> <th>160 to 200</th> <th>250 to 350</th> <th>400</th> <th>450</th> </tr> <tr> <td rowspan="2">Impedance ratio (max.)</td> <td>Z(-25°C) / Z(+20°C)</td> <td>5</td> <td>4</td> <td>3</td> <td>2</td> <td>2</td> <td>2</td> <td>3</td> <td>4</td> <td>6</td> <td>15</td> </tr> <tr> <td>Z(-40°C) / Z(+20°C)</td> <td>10</td> <td>8</td> <td>6</td> <td>4</td> <td>3</td> <td>3</td> <td>4</td> <td>8</td> <td>10</td> <td>—</td> </tr> </table>	Rated voltage (V)		6.3	10	16	25	35 to 50	63 to 100	160 to 200	250 to 350	400	450	Impedance ratio (max.)	Z(-25°C) / Z(+20°C)	5	4	3	2	2	2	3	4	6	15	Z(-40°C) / Z(+20°C)	10	8	6	4	3	3	4	8	10
Rated voltage (V)		6.3	10	16	25	35 to 50	63 to 100	160 to 200	250 to 350	400	450																								
Impedance ratio (max.)	Z(-25°C) / Z(+20°C)	5	4	3	2	2	2	3	4	6	15																								
	Z(-40°C) / Z(+20°C)	10	8	6	4	3	3	4	8	10	—																								
Endurance	The specifications listed at right shall be met when the capacitors are restored to 20°C after the rated voltage is applied for 2000 hours (1000 hours for φ8) at 105°C.																																		
	Capacitance change	Within ±20% of the initial capacitance value																																	
	tan δ	200% or less than the initial specified value																																	
Shelf Life	After storing the capacitors under no load at 105°C for 1000 hours and then performing voltage treatment based on JIS C 5101-4 clause 4.1 at 20°C, they shall meet the specified values for the endurance characteristics listed above.																																		
		Leakage current	Less than or equal to the initial specified value																																
Marking	Printed with white color letter on black sleeve.																																		

※ I : Leakage Current (µA), C : Rated Capacitance (µF), V : Rated Voltage (V)

Radial Lead Type

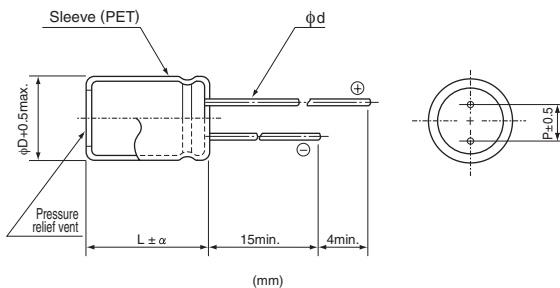

	8	10	12.5	16	18
φD	8	10	12.5	16	18
P	3.5	5.0	5.0	7.5	7.5
φd	0.6	0.6	0.6	0.8	0.8

α	(L < 20)	1.5
	(L ≥ 20)	2.0

- Please refer to the Guidelines for Aluminum Electrolytic Capacitors for end seal configuration information.

Frequency coefficient of rated ripple current

V	Cap.(µF)	Frequency				
		50Hz	120Hz	300Hz	1 kHz	10 kHz or more
6.3 to 100	33 to 68	0.75	1.00	1.35	1.57	2.00
	100 to 470	0.80	1.00	1.23	1.34	1.50
	1000 to 22000	0.85	1.00	1.10	1.13	1.15
160 to 450	2.2 to 220	0.80	1.00	1.25	1.40	1.60
	330 to 470	0.90	1.00	1.10	1.13	1.15

Type numbering system (Example : 10V 3300µF)

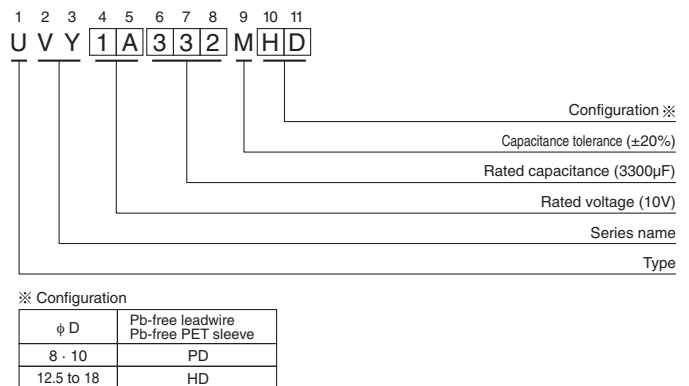

※ Configuration

φ D	Pb-free leadwire Pb-free PET sleeve
8 - 10	PD
12.5 to 18	HD

● Dimension table in next page.

UVY

■ Dimensions

Rated Voltage (V) (code)	Rated Capacitance (μ F)	Case Size ϕ D×L (mm)	tan δ	Leakage Current (μ A)		Rated Ripple (mArms) (105°C/120Hz)	Part Number
				at 20°C after 1 minute	at 20°C after 2 minutes		
6.3 (0J)	1000	8×11.5	0.28	189	63	390	UVY0J102MPD
	2200	10×16	0.30	415.8	138.6	635	UVY0J222MPD
	3300	10×20	0.32	623.7	207.9	840	UVY0J332MPD
	4700	12.5×20	0.34	888.3	296.1	1090	UVY0J472MHD
	6800	12.5×25	0.38	1285.2	428.4	1350	UVY0J682MHD
	10000	16×25	0.46	1890	630	1650	UVY0J103MHD
	15000	16×30.5	0.56	2835	945	1820	UVY0J153MHD
	22000	18×35.5	0.70	4158	1386	2280	UVY0J223MHD
10 (1A)	1000	10×12.5	0.24	300	100	460	UVY1A102MPD
	2200	10×16	0.26	660	220	705	UVY1A222MPD
	3300	12.5×20	0.28	990	330	1000	UVY1A332MHD
	4700	12.5×25	0.30	1410	470	1260	UVY1A472MHD
	6800	16×25	0.34	2040	680	1570	UVY1A682MHD
	10000	16×30.5	0.42	3000	1000	1820	UVY1A103MHD
	15000	16×35.5	0.52	4500	1500	2050	UVY1A153MHD
	22000	18×40	0.66	6600	2200	2420	UVY1A223MHD
16 (1C)	470	8×11.5	0.20	225.6	75.2	315	UVY1C471MPD
	1000	10×12.5	0.20	480	160	500	UVY1C102MPD
	2200	10×20	0.22	1056	352	710	UVY1C222MPD
	3300	12.5×25	0.24	1584	528	1170	UVY1C332MHD
	4700	16×25	0.26	2256	752	1500	UVY1C472MHD
	6800	16×25	0.30	3264	1088	1600	UVY1C682MHD
	10000	16×35.5	0.38	4800	1600	1930	UVY1C103MHD
	15000	18×40	0.48	7200	2400	2210	UVY1C153MHD
25 (1E)	330	8×11.5	0.16	247.5	82.5	275	UVY1E331MPD
	470	10×12.5	0.16	352.5	117.5	380	UVY1E471MPD
	1000	10×16	0.16	750	250	610	UVY1E102MPD
	2200	12.5×25	0.18	1650	550	1090	UVY1E222MHD
	3300	16×25	0.20	2475	825	1400	UVY1E332MHD
	4700	16×25	0.22	3525	1175	1570	UVY1E472MHD
	6800	16×35.5	0.26	5100	1700	1850	UVY1E682MHD
	10000	18×40	0.34	7500	2500	2000	UVY1E103MHD
35 (1V)	220	8×11.5	0.14	231	77	250	UVY1V221MPD
	330	10×12.5	0.14	346.5	115.5	350	UVY1V331MPD
	470	10×16	0.14	493.5	164.5	460	UVY1V471MPD
	1000	12.5×20	0.14	1050	350	810	UVY1V102MHD
	2200	16×25	0.16	2310	770	1260	UVY1V222MHD
	3300	16×30.5	0.18	3465	1155	1500	UVY1V332MHD
	4700	16×35.5	0.20	4935	1645	1780	UVY1V472MHD
	6800	18×40	0.24	7140	2380	2000	UVY1V682MHD

For cut leads, formed leads or taped parts, please add the appropriate code after the size code (12th digit).
If there is no size code in the part number, please add size code "1" and then add the appropriate code.

UVY

■ Dimensions

Rated Voltage (V) (code)	Rated Capacitance (μ F)	Case Size ϕ D \times L (mm)	tan δ	Leakage Current (μ A)		Rated Ripple (mArms) (105°C/120Hz)	Part Number
				at 20°C after 1 minute	at 20°C after 2 minutes		
50 (1H)	100	8 \times 11.5	0.12	150	50	190	UVY1H101MPD
	220	10 \times 12.5	0.12	330	110	300	UVY1H221MPD
	330	10 \times 16	0.12	495	165	410	UVY1H331MPD
	470	10 \times 20	0.12	705	235	540	UVY1H471MPD
	1000	12.5 \times 25	0.12	1500	500	950	UVY1H102MHD
	2200	16 \times 30.5	0.14	3300	1100	1410	UVY1H222MHD
	3300	18 \times 35.5	0.16	4950	1650	1770	UVY1H332MHD
63 (1J)	68	8 \times 11.5	0.10	128.52	42.84	155	UVY1J680MPD
	100	8 \times 11.5	0.10	189	63	200	UVY1J101MPD
	220	10 \times 16	0.10	415.8	138.6	335	UVY1J221MPD
	330	10 \times 20	0.10	623.7	207.9	510	UVY1J331MPD
	470	12.5 \times 20	0.10	888.3	296.1	640	UVY1J471MHD
	1000	16 \times 25	0.10	1890	630	930	UVY1J102MHD
	2200	18 \times 35.5	0.12	4158	1386	1650	UVY1J222MHD
100 (2A)	33	8 \times 11.5	0.08	99	33	130	UVY2A330MPD
	47	8 \times 11.5	0.08	141	47	140	UVY2A470MPD
	68	10 \times 12.5	0.08	204	68	190	UVY2A680MPD
	100	10 \times 16	0.08	300	100	240	UVY2A101MPD
	220	12.5 \times 20	0.08	660	220	390	UVY2A221MHD
	330	12.5 \times 25	0.08	990	330	540	UVY2A331MHD
	470	16 \times 25	0.08	1410	470	715	UVY2A471MHD
	1000	18 \times 35.5	0.08	3000	1000	960	UVY2A102MHD
160 (2C)	10	8 \times 11.5	0.20	164	—	41	UVY2C100MPD
	22	10 \times 12.5	0.20	240.8	—	92	UVY2C220MPD
	33	10 \times 16	0.20	311.2	—	125	UVY2C330MPD
	47	10 \times 20	0.20	400.8	—	150	UVY2C470MPD
	68	12.5 \times 20	0.20	535.2	—	250	UVY2C680MHD
	100	12.5 \times 25	0.20	740	—	310	UVY2C101MHD
	220	16 \times 30.5	0.20	1508	—	410	UVY2C221MHD
	330	18 \times 35.5	0.20	2212	—	570	UVY2C331MHD
	470	18 \times 40	0.20	3108	—	855	UVY2C471MHD
200 (2D)	10	8 \times 11.5	0.20	180	—	57	UVY2D100MPD
	22	10 \times 16	0.20	276	—	105	UVY2D220MPD
	33	10 \times 20	0.20	364	—	140	UVY2D330MPD
	47	12.5 \times 20	0.20	476	—	195	UVY2D470MHD
	68	12.5 \times 25	0.20	644	—	250	UVY2D680MHD
	100	16 \times 25	0.20	900	—	320	UVY2D101MHD
	220	16 \times 35.5	0.20	1860	—	500	UVY2D221MHD
	330	18 \times 40	0.20	2740	—	675	UVY2D331MHD

For cut leads, formed leads or taped parts, please add the appropriate code after the size code (12th digit).
If there is no size code in the part number, please add size code "1" and then add the appropriate code.



■ Dimensions

Rated Voltage (V) (code)	Rated Capacitance (μF)	Case Size φD×L (mm)	tan δ	Leakage Current (μA)		Rated Ripple (mArms) (105°C/120Hz)	Part Number
				at 20°C after 1 minute	at 20°C after 2 minutes		
250 (2E)	10	10×12.5	0.20	200	—	71	UVY2E100MPD
	22	10×20	0.20	320	—	105	UVY2E220MPD
	33	10×20	0.20	430	—	140	UVY2E330MPD
	47	12.5×20	0.20	570	—	190	UVY2E470MHD
	68	16×25	0.20	780	—	270	UVY2E680MHD
	100	16×25	0.20	1100	—	310	UVY2E101MHD
	220	18×35.5	0.20	2300	—	485	UVY2E221MHD
350 (2V)	3.3	8×11.5	0.25	146.2	—	30	UVY2V3R3MPD
	4.7	8×11.5	0.25	165.8	—	39	UVY2V4R7MPD
	10	10×12.5	0.25	240	—	64	UVY2V100MPD
	22	12.5×20	0.25	408	—	105	UVY2V220MHD
	33	12.5×25	0.25	562	—	170	UVY2V330MHD
	47	16×25	0.25	758	—	210	UVY2V470MHD
	68	16×25	0.25	1052	—	285	UVY2V680MHD
	100	18×35.5	0.25	1500	—	370	UVY2V101MHD
400 (2G)	2.2	8×11.5	0.25	128	—	27	UVY2G2R2MPD
	3.3	8×11.5	0.25	152.8	—	34	UVY2G3R3MPD
	4.7	10×12.5	0.25	175.2	—	42	UVY2G4R7MPD
	10	10×16	0.25	260	—	64	UVY2G100MPD
	22	12.5×25	0.25	452	—	140	UVY2G220MHD
	33	16×25	0.25	628	—	170	UVY2G330MHD
	47	16×25	0.25	852	—	200	UVY2G470MHD
	68	16×30.5	0.25	1188	—	240	UVY2G680MHD
450 (2W)	2.2	8×11.5	0.25	139	—	20	UVY2W2R2MPD
	3.3	10×12.5	0.25	159.4	—	28	UVY2W3R3MPD
	4.7	10×12.5	0.25	184.6	—	32	UVY2W4R7MPD
	10	10×20	0.25	280	—	56	UVY2W100MPD
	22	12.5×25	0.25	496	—	100	UVY2W220MHD
	33	16×25	0.25	694	—	125	UVY2W330MHD
	47	16×30.5	0.25	946	—	155	UVY2W470MHD
	68	18×35.5	0.25	1324	—	185	UVY2W680MHD
	100	18×40	0.25	1900	—	200	UVY2W101MHD

For cut leads, formed leads or taped parts, please add the appropriate code after the size code (12th digit).
If there is no size code in the part number, please add size code "1" and then add the appropriate code.

- For formed lead or taped product specifications and minimum order quantity, please refer to the Guidelines for Aluminum Electrolytic Capacitors.



Wide Temperature Range

- Wide temperature range and the same size as UVR.
- Compliant to the RoHS directive (2011/65/EU, (EU)2015/863).

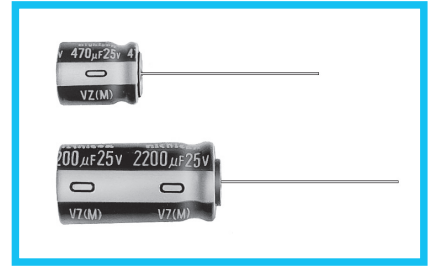
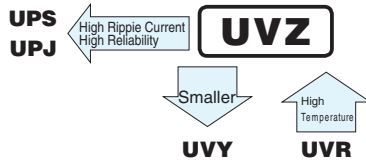

Specifications

Item	Performance Characteristics	
Category Temperature Range	-55 to +105°C (6.3 to 100V), -40 to +105°C (160 to 400V), -25 to +105°C (450V)	
Rated Voltage Range	6.3 to 450V	
Rated Capacitance Range	1 to 22000µF	
Capacitance Tolerance	±20% at 120Hz, 20°C	
Leakage Current ※	Rated voltage (V)	6.3 to 100
		160 to 450
Tangent of loss angle (tan δ)	For capacitance of more than 1000µF, add 0.02 for every increase of 1000µF. Measurement frequency : 120Hz at 20°C	
	Rated voltage (V)	6.3 10 16 25 35 50 63 100 160 to 315 350 to 450
Stability at Low Temperature	Measurement frequency : 120Hz	
	Impedance ratio (max.)	Z(-25°C) / Z(+20°C) 5 4 3 2 2 2 2 2 3 4 6 15
Endurance	The specifications listed at right shall be met when the capacitors are restored to 20°C after the rated voltage is applied for 2000 hours (1000 hours for ϕD = 8) at 105°C.	
	Capacitance change	tan δ
Shelf Life	After storing the capacitors under no load at 105°C for 1000 hours and then performing voltage treatment based on JIS C 5101-4 clause 4.1 at 20°C, they shall meet the specified values for the endurance characteristics listed above.	
	Leakage current	
Marking	Printed with white color letter on black sleeve.	

※ I : Leakage Current (µA), C : Rated Capacitance (µF), V : Rated Voltage (V)

Radial Lead Type

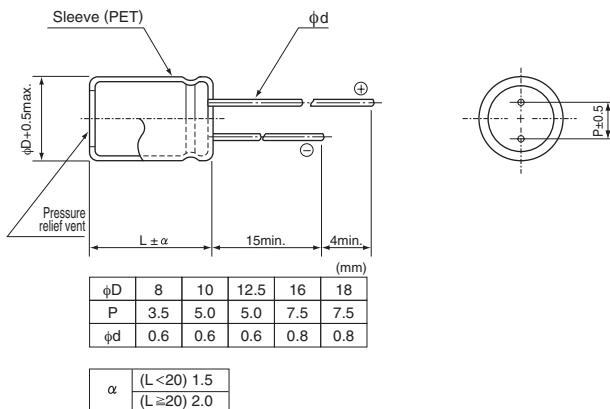

- Please refer to the Guidelines for Aluminum Electrolytic Capacitors for end seal configuration information.

Type numbering system (Example : 10V 1000µF)

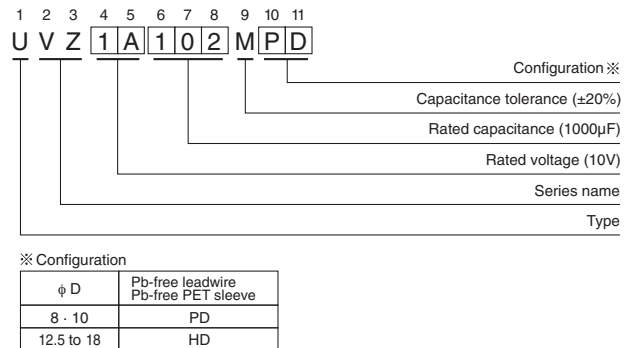

Frequency coefficient of rated ripple current

V	Frequency					
	Cap. (µF)	50Hz	120Hz	300Hz	1 kHz	10 kHz or more
6.3 to 100	33 to 47	0.75	1.00	1.35	1.57	2.00
	100 to 470	0.80	1.00	1.23	1.34	1.50
	1000 to 22000	0.85	1.00	1.10	1.13	1.15
160 to 450	1 to 220	0.80	1.00	1.25	1.40	1.60
	330	0.90	1.00	1.10	1.13	1.15

- Dimension table in next page.



■ Dimensions

Rated Voltage (V) (code)	Rated Capacitance (μ F)	Case Size ϕ D×L (mm)	tan δ	Leakage Current (μ A)		Rated Ripple (mArms) (105°C/120Hz)	Part Number
				at 20°C after 1 minute	at 20°C after 2 minutes		
6.3 (0J)	1000	8×11.5	0.28	189	63	390	UVZ0J102MPD
	2200	10×20	0.30	415.8	138.6	710	UVZ0J222MPD
	3300	10×20	0.32	623.7	207.9	840	UVZ0J332MPD
	4700	12.5×20	0.34	888.3	296.1	1090	UVZ0J472MHD
	6800	12.5×25	0.38	1285.2	428.4	1350	UVZ0J682MHD
	10000	16×25	0.46	1890	630	1650	UVZ0J103MHD
	15000	16×35.5	0.56	2835	945	2010	UVZ0J153MHD
	22000	18×40	0.70	4158	1386	2350	UVZ0J223MHD
10 (1A)	1000	10×12.5	0.24	300	100	460	UVZ1A102MPD
	2200	10×20	0.26	660	220	760	UVZ1A222MPD
	3300	12.5×20	0.28	990	330	1000	UVZ1A332MHD
	4700	12.5×25	0.30	1410	470	1260	UVZ1A472MHD
	6800	16×25	0.34	2040	680	1570	UVZ1A682MHD
	10000	16×35.5	0.42	3000	1000	1890	UVZ1A103MHD
	15000	18×35.5	0.52	4500	1500	2180	UVZ1A153MHD
16 (1C)	330	8×11.5	0.20	158.4	52.8	265	UVZ1C331MPD
	470	8×11.5	0.20	225.6	75.2	315	UVZ1C471MPD
	1000	10×16	0.20	480	160	560	UVZ1C102MPD
	2200	12.5×20	0.22	1056	352	920	UVZ1C222MHD
	3300	12.5×25	0.24	1584	528	1170	UVZ1C332MHD
	4700	16×25	0.26	2256	752	1480	UVZ1C472MHD
	6800	16×35.5	0.30	3264	1088	1780	UVZ1C682MHD
	10000	18×35.5	0.38	4800	1600	2060	UVZ1C103MHD
25 (1E)	220	8×11.5	0.16	165	55	240	UVZ1E221MPD
	330	10×12.5	0.16	247.5	82.5	315	UVZ1E331MPD
	470	10×12.5	0.16	352.5	117.5	380	UVZ1E471MPD
	1000	10×20	0.16	750	250	680	UVZ1E102MPD
	2200	12.5×25	0.18	1650	550	1090	UVZ1E222MHD
	3300	16×25	0.20	2475	825	1400	UVZ1E332MHD
	4700	16×30.5	0.22	3525	1175	1710	UVZ1E472MHD
	6800	18×35.5	0.26	5100	1700	2040	UVZ1E682MHD
35 (1V)	220	10×12.5	0.14	231	77	275	UVZ1V221MPD
	330	10×12.5	0.14	346.5	115.5	350	UVZ1V331MPD
	470	10×16	0.14	493.5	164.5	460	UVZ1V471MPD
	1000	12.5×20	0.14	1050	350	810	UVZ1V102MHD
	2200	16×25	0.16	2310	770	1260	UVZ1V222MHD
	3300	16×35.5	0.18	3465	1155	1610	UVZ1V332MHD
	4700	18×35.5	0.20	4935	1645	1910	UVZ1V472MHD
50 (1H)	100	8×11.5	0.12	150	50	190	UVZ1H101MPD
	220	10×12.5	0.12	330	110	300	UVZ1H221MPD
	330	10×16	0.12	495	165	410	UVZ1H331MPD
	470	12.5×20	0.12	705	235	530	UVZ1H471MHD
	1000	12.5×25	0.12	1500	500	950	UVZ1H102MHD
	2200	16×35.5	0.14	3300	1100	1470	UVZ1H222MHD
	3300	18×35.5	0.16	4950	1650	1770	UVZ1H332MHD
63 (1J)	100	10×12.5	0.10	189	63	215	UVZ1J101MPD
	220	10×16	0.10	415.8	138.6	335	UVZ1J221MPD
	330	10×20	0.10	623.7	207.9	510	UVZ1J331MPD
	470	12.5×20	0.10	888.3	296.1	640	UVZ1J471MHD
	1000	16×25	0.10	1890	630	930	UVZ1J102MHD
	2200	18×35.5	0.12	4158	1386	1650	UVZ1J222MHD

For cut leads, formed leads or taped parts, please add the appropriate code after the size code (12th digit).
If there is no size code in the part number, please add size code "1" and then add the appropriate code.

UVZ

■ Dimensions

Rated Voltage (V) (code)	Rated Capacitance (μ F)	Case Size ϕ D×L (mm)	tan δ	Leakage Current (μ A)		Rated Ripple (mArms) (105°C/120Hz)	Part Number
				at 20°C after 1 minute	at 20°C after 2 minutes		
100 (2A)	33	8×11.5	0.08	99	33	130	UVZ2A330MPD
	47	10×12.5	0.08	141	47	165	UVZ2A470MPD
	100	10×20	0.08	300	100	265	UVZ2A101MPD
	220	12.5×25	0.08	660	220	440	UVZ2A221MHD
	330	12.5×25	0.08	990	330	540	UVZ2A331MHD
	470	16×25	0.08	1410	470	715	UVZ2A471MHD
	1000	18×40	0.08	3000	1000	985	UVZ2A102MHD
160 (2C)	10	8×11.5	0.20	164	—	41	UVZ2C100MPD
	22	10×16	0.20	240.8	—	100	UVZ2C220MPD
	33	10×20	0.20	311.2	—	145	UVZ2C330MPD
	47	12.5×20	0.20	400.8	—	195	UVZ2C470MHD
	100	12.5×25	0.20	740	—	215	UVZ2C101MHD
	220	16×35.5	0.20	1508	—	570	UVZ2C221MHD
	330	18×40	0.20	2212	—	750	UVZ2C331MHD
200 (2D)	4.7	8×11.5	0.20	134	—	39	UVZ2D4R7MPD
	10	10×12.5	0.20	180	—	65	UVZ2D100MPD
	22	10×20	0.20	276	—	120	UVZ2D220MPD
	33	12.5×20	0.20	364	—	160	UVZ2D330MHD
	47	12.5×20	0.20	476	—	195	UVZ2D470MHD
	100	16×30.5	0.20	900	—	375	UVZ2D101MHD
	220	18×35.5	0.20	1860	—	575	UVZ2D221MHD
250 (2E)	3.3	8×11.5	0.20	122.5	—	32	UVZ2E3R3MPD
	4.7	8×11.5	0.20	147	—	39	UVZ2E4R7MPD
	10	10×16	0.20	200	—	74	UVZ2E100MPD
	22	12.5×20	0.20	320	—	130	UVZ2E220MHD
	33	12.5×20	0.20	430	—	160	UVZ2E330MHD
	47	12.5×25	0.20	570	—	210	UVZ2E470MHD
	100	16×30.5	0.20	1100	—	365	UVZ2E101MHD
315 (2F)	2.2	8×11.5	0.20	109.3	—	26	UVZ2F2R2MPD
	3.3	10×12.5	0.20	141.58	—	38	UVZ2F3R3MPD
	4.7	10×12.5	0.20	159.22	—	45	UVZ2F4R7MPD
	10	10×20	0.20	226	—	80	UVZ2F100MPD
	22	12.5×20	0.20	377.2	—	115	UVZ2F220MHD
	33	16×25	0.20	515.8	—	195	UVZ2F330MHD
	47	16×25	0.20	692.2	—	230	UVZ2F470MHD
	100	18×35.5	0.20	1360	—	395	UVZ2F101MHD
350 (2V)	2.2	8×11.5	0.25	117	—	26	UVZ2V2R2MPD
	3.3	10×12.5	0.25	146.2	—	38	UVZ2V3R3MPD
	4.7	10×12.5	0.25	165.8	—	45	UVZ2V4R7MPD
	10	10×20	0.25	240	—	80	UVZ2V100MPD
	22	12.5×25	0.25	408	—	115	UVZ2V220MHD
	33	16×25	0.25	562	—	195	UVZ2V330MHD
	47	16×35.5	0.25	758	—	270	UVZ2V470MHD
	100	18×40	0.25	1500	—	420	UVZ2V101MHD

For cut leads, formed leads or taped parts, please add the appropriate code after the size code (12th digit).
If there is no size code in the part number, please add size code "1" and then add the appropriate code.

UVZ

■ Dimensions

Rated Voltage (V) (code)	Rated Capacitance (μ F)	Case Size ϕ D \times L (mm)	tan δ	Leakage Current (μ A)		Rated Ripple (mArms) (105°C/120Hz)	Part Number
				at 20°C after 1 minute	at 20°C after 2 minutes		
400 (2G)	1	8 \times 11.5	0.25	80	—	17	UVZ2G010MPD
	2.2	10 \times 12.5	0.25	128	—	30	UVZ2G2R2MPD
	3.3	10 \times 12.5	0.25	152.8	—	38	UVZ2G3R3MPD
	4.7	10 \times 16	0.25	175.2	—	50	UVZ2G4R7MPD
	10	12.5 \times 20	0.25	260	—	90	UVZ2G100MHD
	22	16 \times 25	0.25	452	—	165	UVZ2G220MHD
	33	16 \times 30.5	0.25	628	—	215	UVZ2G330MHD
	47	16 \times 35.5	0.25	852	—	270	UVZ2G470MHD
450 (2W)	1	8 \times 11.5	0.25	85	—	13	UVZ2W010MPD
	2.2	10 \times 12.5	0.25	139	—	23	UVZ2W2R2MPD
	3.3	10 \times 16	0.25	159.4	—	31	UVZ2W3R3MPD
	4.7	10 \times 20	0.25	184.6	—	40	UVZ2W4R7MPD
	10	12.5 \times 20	0.25	280	—	65	UVZ2W100MHD
	22	16 \times 25	0.25	496	—	115	UVZ2W220MHD
	33	16 \times 35.5	0.25	694	—	165	UVZ2W330MHD
	47	18 \times 40	0.25	946	—	185	UVZ2W470MHD

For cut leads, formed leads or taped parts, please add the appropriate code after the size code (12th digit).
If there is no size code in the part number, please add size code "1" and then add the appropriate code.

- For formed lead or taped product specifications and minimum order quantity, please refer to the Guidelines for Aluminum Electrolytic Capacitors.

ALUMINUM ELECTROLYTIC CAPACITORS

URS

Compact & Low-profile Sized



- Compact & low profile case size.
- Compliant to the RoHS directive (2011/65/EU,(EU)2015/863).

Valued marked with an ※ in the dimension table are scheduled to be discontinued and are not recommended for new designs.

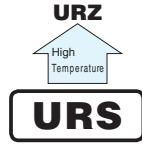

Specifications

Item	Performance Characteristics																																					
Category Temperature Range	-40 to +85°C																																					
Rated Voltage Range	6.3 to 400V																																					
Rated Capacitance Range	10 to 10000µF																																					
Capacitance Tolerance	±20% at 120Hz, 20°C																																					
Leakage Current ※	<table border="1"> <tr> <th>Rated voltage (V)</th> <th>6.3 to 100</th> <th>160 to 400</th> </tr> <tr> <td></td> <td>After 1 minute's application of rated voltage at 20°C, leakage current is not more than 0.03CV(µA). After 2 minutes' application of rated voltage at 20°C, leakage current is not more than 0.01CV(µA).</td> <td>After 1 minute's application of rated voltage at 20°C, I = 0.04CV+100 (µA) or less</td> </tr> </table>	Rated voltage (V)	6.3 to 100	160 to 400		After 1 minute's application of rated voltage at 20°C, leakage current is not more than 0.03CV(µA). After 2 minutes' application of rated voltage at 20°C, leakage current is not more than 0.01CV(µA).	After 1 minute's application of rated voltage at 20°C, I = 0.04CV+100 (µA) or less																															
	Rated voltage (V)	6.3 to 100	160 to 400																																			
	After 1 minute's application of rated voltage at 20°C, leakage current is not more than 0.03CV(µA). After 2 minutes' application of rated voltage at 20°C, leakage current is not more than 0.01CV(µA).	After 1 minute's application of rated voltage at 20°C, I = 0.04CV+100 (µA) or less																																				
Tangent of loss angle (tan δ)	For capacitance of more than 1000µF, add 0.02 for every increase of 1000µF. Measurement frequency : 120Hz at 20°C <table border="1"> <tr> <th>Rated voltage (V)</th> <th>6.3</th> <th>10</th> <th>16</th> <th>25</th> <th>35</th> <th>50</th> <th>63</th> <th>100</th> <th>160</th> <th>200</th> <th>250</th> <th>400</th> </tr> <tr> <td>tan δ (max.)</td> <td>0.28</td> <td>0.24</td> <td>0.20</td> <td>0.16</td> <td>0.14</td> <td>0.12</td> <td>0.10</td> <td>0.08</td> <td>0.20</td> <td>0.20</td> <td>0.20</td> <td>0.25</td> </tr> </table>	Rated voltage (V)	6.3	10	16	25	35	50	63	100	160	200	250	400	tan δ (max.)	0.28	0.24	0.20	0.16	0.14	0.12	0.10	0.08	0.20	0.20	0.20	0.25											
Rated voltage (V)	6.3	10	16	25	35	50	63	100	160	200	250	400																										
tan δ (max.)	0.28	0.24	0.20	0.16	0.14	0.12	0.10	0.08	0.20	0.20	0.20	0.25																										
Stability at Low Temperature	Measurement frequency : 120Hz																																					
	<table border="1"> <tr> <th>Rated voltage (V)</th> <th>6.3</th> <th>10</th> <th>16</th> <th>25</th> <th>35</th> <th>50</th> <th>63</th> <th>100</th> <th>160</th> <th>200</th> <th>250</th> <th>400</th> </tr> <tr> <td rowspan="2">Impedance ratio (max.)</td> <td>Z(-25°C) / Z(+20°C)</td> <td>5</td> <td>4</td> <td>3</td> <td>2</td> <td>2</td> <td>2</td> <td>2</td> <td>2</td> <td>3</td> <td>3</td> <td>6</td> </tr> <tr> <td>Z(-40°C) / Z(+20°C)</td> <td>12</td> <td>10</td> <td>8</td> <td>5</td> <td>4</td> <td>3</td> <td>3</td> <td>3</td> <td>4</td> <td>4</td> <td>10</td> </tr> </table>	Rated voltage (V)	6.3	10	16	25	35	50	63	100	160	200	250	400	Impedance ratio (max.)	Z(-25°C) / Z(+20°C)	5	4	3	2	2	2	2	2	3	3	6	Z(-40°C) / Z(+20°C)	12	10	8	5	4	3	3	3	4	4
Rated voltage (V)	6.3	10	16	25	35	50	63	100	160	200	250	400																										
Impedance ratio (max.)	Z(-25°C) / Z(+20°C)	5	4	3	2	2	2	2	2	3	3	6																										
	Z(-40°C) / Z(+20°C)	12	10	8	5	4	3	3	3	4	4	10																										
Endurance	The specifications listed at right shall be met when the capacitors are restored to 20°C after the rated voltage is applied for 2000 hours at 85°C.																																					
	Capacitance change	Within ±20% of the initial capacitance value																																				
	tan δ	200% or less than the initial specified value																																				
Shelf Life	The specifications listed at right shall be met when the capacitors are restored to 20°C after the rated voltage is applied for 2000 hours at 85°C.																																					
		Leakage current	Less than or equal to the initial specified value																																			
Marking	Printed with white color letter on black sleeve.																																					

※ I : Leakage Current (µA), C : Rated Capacitance (µF), V : Rated Voltage (V)

Radial Lead Type

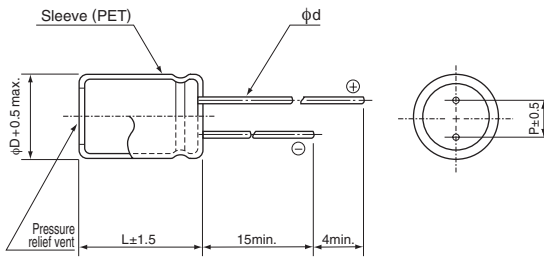

	(mm)			
φD	10	12.5	16	18
P	5.0	5.0	7.5	7.5
φd	0.6	0.6	0.8	0.8

Type numbering system (Example : 16V 1000µF)

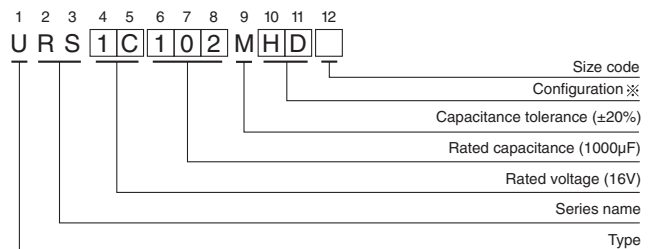

※ Configuration

φ D	Pb-free leadwire Pb-free PET sleeve
10	PD
12.5 to 18	HD

- Please refer to the Guidelines for Aluminum Electrolytic Capacitors for end seal configuration information.

Frequency coefficient of rated ripple current

V	Cap.(µF)	Frequency				
		50Hz	120Hz	300Hz	1 kHz	10kHz or more
6.3 to 100	47	0.75	1.00	1.35	1.57	2.00
	100 to 470	0.80	1.00	1.23	1.34	1.50
	1000 to 10000	0.85	1.00	1.10	1.13	1.15
160 to 400	10 to 150	0.80	1.00	1.25	1.40	1.60

● Dimension table in next page.

URS

■ Dimensions

Rated Voltage (V) (code)	Rated Capacitance (μ F)	Case Size ϕ D \times L (mm)	tan δ	Leakage Current (μ A)		Rated Ripple (mArms) (85°C/120Hz)	Part Number	
				at 20°C after 1 minute	at 20°C after 2 minutes			
6.3 (0J)	2200	12.5 \times 15	0.30	415.8	138.6	890	※URS0J222MHD	
	3300	16 \times 15	0.32	623.7	207.9	1200	※URS0J332MHD	
	4700	16 \times 15	0.34	888.3	296.1	1410	※URS0J472MHD	
	6800	18 \times 15	0.38	1285.2	428.4	1660	※URS0J682MHD	
	10000	18 \times 20	0.46	1890	630	2020	※URS0J103MHD	
10 (1A)	1000	10 \times 12.5	0.24	300	100	620	※URS1A102MPD	
	2200	12.5 \times 15	0.26	660	220	960	※URS1A222MHD	
	3300	16 \times 15	0.28	990	330	1300	※URS1A332MHD	
	4700	18 \times 15	0.30	1410	470	1550	※URS1A472MHD	
	6800	18 \times 20	0.34	2040	680	1850	※URS1A682MHD	
10000	18 \times 25	0.42	3000	1000	2350	※URS1A103MHD		
	16 (1C)	1000	12.5 \times 12.5	0.20	480	160	720	URS1C102MHD
		2200	16 \times 15	0.22	1056	352	1160	URS1C222MHD
		3300	18 \times 15	0.24	1584	528	1460	URS1C332MHD
		4700	18 \times 20	0.26	2256	752	1770	URS1C472MHD
6800		18 \times 25	0.30	3264	1088	2170	URS1C682MHD	
25 (1E)	470	10 \times 12.5	0.16	352.5	117.5	530	URS1E471MPD	
	1000	12.5 \times 15	0.16	750	250	830	URS1E102MHD	
	2200	18 \times 15	0.18	1650	550	1360	URS1E222MHD	
	3300	18 \times 20	0.20	2475	825	1720	URS1E332MHD	
	4700	18 \times 25	0.22	3525	1175	2050	URS1E472MHD	
35 (1V)	330	10 \times 12.5	0.14	346.5	115.5	480	URS1V331MPD	
	470	12.5 \times 12.5	0.14	493.5	164.5	590	URS1V471MHD	
	1000	16 \times 15	0.14	1050	350	1010	URS1V102MHD	
	2200	18 \times 20	0.16	2310	770	1560	URS1V222MHD	
50 (1H)	220	10 \times 12.5	0.12	330	110	420	URS1H221MPD	
	330	12.5 \times 12.5	0.12	495	165	530	URS1H331MHD	
	470	16 \times 15	0.12	705	235	750	URS1H471MHD	
	1000	18 \times 20	0.12	1500	500	1160	URS1H102MHD	
63 (1J)	220	12.5 \times 12.5	0.10	415.8	138.6	490	URS1J221MHD	
	330	12.5 \times 15	0.10	623.7	207.9	710	URS1J331MHD	
	470	16 \times 15	0.10	888.3	296.1	900	URS1J471MHD	
100 (2A)	47	10 \times 12.5	0.08	141	47	230	URS2A470MPD	
	100	12.5 \times 15	0.08	300	100	370	URS2A101MHD	
	220	16 \times 15	0.08	660	220	620	URS2A221MHD	
	330	18 \times 15	0.08	990	330	760	URS2A331MHD	
160 (2C)	47	16 \times 15	0.20	400.8	—	420	※URS2C470MHD	
	68	18 \times 15	0.20	535.2	—	490	※URS2C680MHD	
	68	16 \times 20	0.20	535.2	—	490	※URS2C680MHD6	

For cut leads, formed leads or taped parts, please add the appropriate code after the size code (12th digit).
If there is no size code in the part number, please add size code "1" and then add the appropriate code.

URS

■ Dimensions

Rated Voltage (V) (code)	Rated Capacitance (μ F)	Case Size ϕ D \times L (mm)	tan δ	Leakage Current (μ A)		Rated Ripple (mArms) (85°C/120Hz)	Part Number
				at 20°C after 1 minute	at 20°C after 2 minutes		
160 (2C)	100	18 \times 20	0.20	740	—	590	※URS2C101MHD
	150	18 \times 25	0.20	1060	—	710	※URS2C151MHD
200 (2D)	33	16 \times 15	0.20	364	—	350	※URS2D330MHD
	47	18 \times 15	0.20	476	—	420	※URS2D470MHD
	47	16 \times 20	0.20	476	—	420	※URS2D470MHD6
	68	18 \times 20	0.20	644	—	490	※URS2D680MHD
	100	18 \times 25	0.20	900	—	590	※URS2D101MHD
	150	18 \times 25	0.20	1300	—	710	※URS2D151MHD
250 (2E)	22	16 \times 15	0.20	320	—	280	※URS2E220MHD
	33	18 \times 15	0.20	430	—	350	※URS2E330MHD
	33	16 \times 20	0.20	430	—	350	※URS2E330MHD6
	47	18 \times 20	0.20	570	—	420	※URS2E470MHD
	68	18 \times 20	0.20	780	—	490	※URS2E680MHD
	100	18 \times 25	0.20	1100	—	590	※URS2E101MHD
400 (2G)	10	16 \times 15	0.25	260	—	140	※URS2G100MHD
	22	18 \times 15	0.25	452	—	280	※URS2G220MHD
	22	16 \times 20	0.25	452	—	280	※URS2G220MHD6
	33	18 \times 20	0.25	628	—	350	※URS2G330MHD
	47	18 \times 25	0.25	852	—	420	※URS2G470MHD

For cut leads, formed leads or taped parts, please add the appropriate code after the size code (12th digit).
If there is no size code in the part number, please add size code "1" and then add the appropriate code.

- For formed lead or taped product specifications and minimum order quantity, please refer to the Guidelines for Aluminum Electrolytic Capacitors.

ALUMINUM ELECTROLYTIC CAPACITORS

URZ Compact & Low-Profile Sized,
Wide Temperature Range



Smaller

- Wide temperature range and same size as URS.
- Compliant to the RoHS directive (2011/65/EU,(EU)2015/863).

Valued marked with an ※ in the dimension table are scheduled to be discontinued and are not recommended for new designs.

URZ

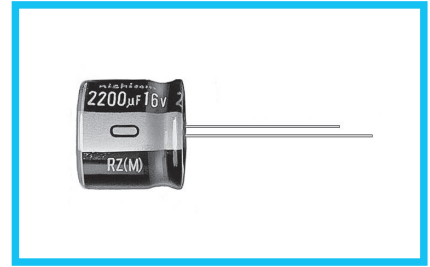

Specifications

Item	Performance Characteristics																																					
Category Temperature Range	-55 to +105°C (6.3 to 100V) , -40 to +105°C (160 to 400V)																																					
Rated Voltage Range	6.3 to 400V																																					
Rated Capacitance Range	10 to 10000µF																																					
Capacitance Tolerance	±20% at 120Hz, 20°C																																					
Leakage Current ※	<table border="1"> <tr> <th>Rated voltage (V)</th> <th>6.3 to 100</th> <th>160 to 400</th> </tr> <tr> <td>_____</td> <td>After 1 minute's application of rated voltage at 20°C, leakage current is not more than 0.03CV(µA). After 2 minutes' application of rated voltage at 20°C, leakage current is not more than 0.01CV(µA).</td> <td>After 1 minute's application of rated voltage at 20°C, I = 0.04CV+100 (µA) or less</td> </tr> </table>	Rated voltage (V)	6.3 to 100	160 to 400	_____	After 1 minute's application of rated voltage at 20°C, leakage current is not more than 0.03CV(µA). After 2 minutes' application of rated voltage at 20°C, leakage current is not more than 0.01CV(µA).	After 1 minute's application of rated voltage at 20°C, I = 0.04CV+100 (µA) or less																															
	Rated voltage (V)	6.3 to 100	160 to 400																																			
_____	After 1 minute's application of rated voltage at 20°C, leakage current is not more than 0.03CV(µA). After 2 minutes' application of rated voltage at 20°C, leakage current is not more than 0.01CV(µA).	After 1 minute's application of rated voltage at 20°C, I = 0.04CV+100 (µA) or less																																				
Tangent of loss angle (tan δ)	For capacitance of more than 1000µF, add 0.02 for every increase of 1000µF. Measurement frequency : 120Hz at 20°C <table border="1"> <tr> <th>Rated voltage (V)</th> <th>6.3</th> <th>10</th> <th>16</th> <th>25</th> <th>35</th> <th>50</th> <th>63</th> <th>100</th> <th>160</th> <th>200</th> <th>250</th> <th>400</th> </tr> <tr> <td>tan δ (max.)</td> <td>0.28</td> <td>0.24</td> <td>0.20</td> <td>0.16</td> <td>0.14</td> <td>0.12</td> <td>0.10</td> <td>0.08</td> <td>0.20</td> <td>0.20</td> <td>0.20</td> <td>0.25</td> </tr> </table>	Rated voltage (V)	6.3	10	16	25	35	50	63	100	160	200	250	400	tan δ (max.)	0.28	0.24	0.20	0.16	0.14	0.12	0.10	0.08	0.20	0.20	0.20	0.25											
Rated voltage (V)	6.3	10	16	25	35	50	63	100	160	200	250	400																										
tan δ (max.)	0.28	0.24	0.20	0.16	0.14	0.12	0.10	0.08	0.20	0.20	0.20	0.25																										
Stability at Low Temperature	Measurement frequency : 120Hz																																					
	<table border="1"> <tr> <th>Rated voltage (V)</th> <th>6.3</th> <th>10</th> <th>16</th> <th>25</th> <th>35</th> <th>50</th> <th>63</th> <th>100</th> <th>160</th> <th>200</th> <th>250</th> <th>400</th> </tr> <tr> <td rowspan="2">Impedance ratio (max.)</td> <td>Z(-25°C) / Z(+20°C)</td> <td>5</td> <td>4</td> <td>3</td> <td>2</td> <td>2</td> <td>2</td> <td>2</td> <td>2</td> <td>3</td> <td>3</td> <td>6</td> </tr> <tr> <td>Z(-40°C) / Z(+20°C)</td> <td>10</td> <td>8</td> <td>6</td> <td>4</td> <td>3</td> <td>3</td> <td>3</td> <td>3</td> <td>4</td> <td>4</td> <td>10</td> </tr> </table>	Rated voltage (V)	6.3	10	16	25	35	50	63	100	160	200	250	400	Impedance ratio (max.)	Z(-25°C) / Z(+20°C)	5	4	3	2	2	2	2	2	3	3	6	Z(-40°C) / Z(+20°C)	10	8	6	4	3	3	3	3	4	4
Rated voltage (V)	6.3	10	16	25	35	50	63	100	160	200	250	400																										
Impedance ratio (max.)	Z(-25°C) / Z(+20°C)	5	4	3	2	2	2	2	2	3	3	6																										
	Z(-40°C) / Z(+20°C)	10	8	6	4	3	3	3	3	4	4	10																										
Endurance	The specifications listed at right shall be met when the capacitors are restored to 20°C after the rated voltage is applied for 1000 hours at 105°C.																																					
	Capacitance change	Within ±20% of the initial capacitance value																																				
	tan δ	200% or less than the initial specified value																																				
Shelf Life	After storing the capacitors under no load at 105°C for 1000 hours and then performing voltage treatment based on JIS C 5101-4 clause 4.1 at 20°C, they shall meet the specified values for the endurance characteristics listed above.																																					
		Leakage current	Less than or equal to the initial specified value																																			
Marking	Printed with white color letter on black sleeve.																																					

※ I : Leakage Current (µA), C : Rated Capacitance (µF), V : Rated Voltage (V)

Radial Lead Type

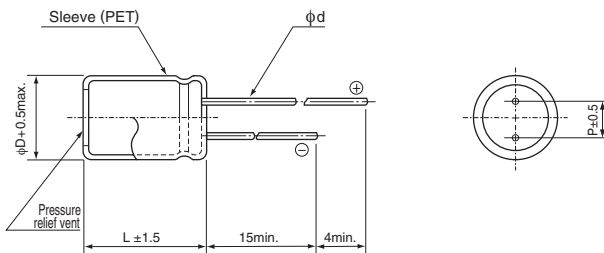

	(mm)			
φD	10	12.5	16	18
P	5.0	5.0	7.5	7.5
φd	0.6	0.6	0.8	0.8

Type numbering system (Example : 16V 1000µF)

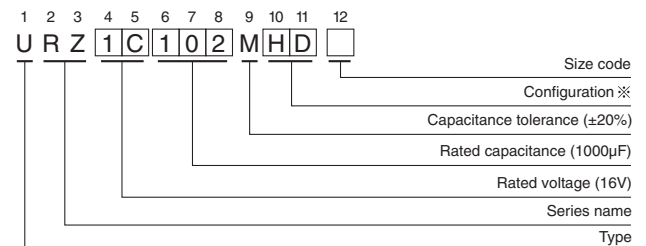

※ Configuration

φ D	Pb-free leadwire Pb-free PET sleeve
10	PD
12.5 to 18	HD

- Please refer to the Guidelines for Aluminum Electrolytic Capacitors for end seal configuration information.

Frequency coefficient of rated ripple current

V	Frequency					
	Cap.(µF)	50Hz	120Hz	300Hz	1 kHz	10kHz or more
6.3 to 100	47	0.75	1.00	1.35	1.57	2.00
	100 to 470	0.80	1.00	1.23	1.34	1.50
	1000 to 10000	0.85	1.00	1.10	1.13	1.15
160 to 400	10 to 150	0.80	1.00	1.25	1.40	1.60

• Dimension table in next page.

URZ

■ Dimensions

Rated Voltage (V) (code)	Rated Capacitance (μ F)	Case Size ϕ D×L (mm)	tan δ	Leakage Current (μ A)		Rated Ripple (mArms) (105°C/120Hz)	Part Number	
				at 20°C after 1 minute	at 20°C after 2 minutes			
6.3 (0J)	2200	12.5×15	0.30	415.8	138.6	635	※URZ0J222MHD	
	3300	16×15	0.32	623.7	207.9	860	※URZ0J332MHD	
	4700	16×15	0.34	888.3	296.1	1010	※URZ0J472MHD	
	6800	18×15	0.38	1285.2	428.4	1200	※URZ0J682MHD	
	10000	18×20	0.46	1890	630	1450	※URZ0J103MHD	
10 (1A)	1000	10×12.5	0.24	300	100	450	※URZ1A102MPD	
	2200	12.5×15	0.26	660	220	690	※URZ1A222MHD	
	3300	16×15	0.28	990	330	940	※URZ1A332MHD	
	4700	18×15	0.30	1410	470	1120	※URZ1A472MHD	
	6800	18×20	0.34	2040	680	1330	※URZ1A682MHD	
10000	18×25	0.42	3000	1000	1700	※URZ1A103MHD		
	16 (1C)	1000	12.5×12.5	0.20	480	160	520	URZ1C102MHD
		2200	16×15	0.22	1056	352	830	URZ1C222MHD
		3300	18×15	0.24	1584	528	1050	URZ1C332MHD
		4700	18×20	0.26	2256	752	1260	URZ1C472MHD
6800		18×25	0.30	3264	1088	1560	URZ1C682MHD	
25 (1E)	470	10×12.5	0.16	352.5	117.5	370	URZ1E471MPD	
	1000	12.5×15	0.16	750	250	590	URZ1E102MHD	
	2200	18×15	0.18	1650	550	970	URZ1E222MHD	
	3300	18×20	0.20	2475	825	1220	URZ1E332MHD	
	4700	18×25	0.22	3525	1175	1470	URZ1E472MHD	
35 (1V)	330	10×12.5	0.14	346.5	115.5	340	URZ1V331MPD	
	470	12.5×12.5	0.14	493.5	164.5	420	URZ1V471MHD	
	1000	16×15	0.14	1050	350	720	URZ1V102MHD	
	2200	18×20	0.16	2310	770	1110	URZ1V222MHD	
50 (1H)	220	10×12.5	0.12	330	110	290	URZ1H221MPD	
	330	12.5×12.5	0.12	495	165	370	URZ1H331MHD	
	470	16×15	0.12	705	235	540	URZ1H471MHD	
	1000	18×20	0.12	1500	500	830	URZ1H102MHD	
63 (1J)	220	12.5×12.5	0.10	415.8	138.6	335	URZ1J221MHD	
	330	12.5×15	0.10	623.7	207.9	510	URZ1J331MHD	
	470	16×15	0.10	888.3	296.1	640	URZ1J471MHD	
100 (2A)	47	10×12.5	0.08	141	47	165	URZ2A470MPD	
	100	12.5×15	0.08	300	100	265	URZ2A101MHD	
	220	16×15	0.08	660	220	440	URZ2A221MHD	
	330	18×15	0.08	990	330	540	URZ2A331MHD	
160 (2C)	47	16×15	0.20	400.8	—	300	※URZ2C470MHD	
	68	18×15	0.20	535.2	—	350	※URZ2C680MHD	
	68	16×20	0.20	535.2	—	350	※URZ2C680MHD6	

For cut leads, formed leads or taped parts, please add the appropriate code after the size code (12th digit).
If there is no size code in the part number, please add size code "1" and then add the appropriate code.

URZ

■ Dimensions

Rated Voltage (V) (code)	Rated Capacitance (μ F)	Case Size ϕ D \times L (mm)	tan δ	Leakage Current (μ A)		Rated Ripple (mA _{rms}) (105°C/120Hz)	Part Number
				at 20°C after 1 minute	at 20°C after 2 minutes		
160 (2C)	100	18 \times 20	0.20	740	—	420	*URZ2C101MHD
	150	18 \times 25	0.20	1060	—	510	*URZ2C151MHD
200 (2D)	33	16 \times 15	0.20	364	—	250	*URZ2D330MHD
	47	18 \times 15	0.20	476	—	300	*URZ2D470MHD
	47	16 \times 20	0.20	476	—	300	*URZ2D470MHD6
	68	18 \times 20	0.20	644	—	350	*URZ2D680MHD
	100	18 \times 25	0.20	900	—	420	*URZ2D101MHD
	150	18 \times 25	0.20	1300	—	510	*URZ2D151MHD
250 (2E)	22	16 \times 15	0.20	320	—	200	*URZ2E220MHD
	33	18 \times 15	0.20	430	—	250	*URZ2E330MHD
	33	16 \times 20	0.20	430	—	250	*URZ2E330MHD6
	47	18 \times 20	0.20	570	—	300	*URZ2E470MHD
	68	18 \times 20	0.20	780	—	350	*URZ2E680MHD
	100	18 \times 25	0.20	1100	—	420	*URZ2E101MHD
400 (2G)	10	16 \times 15	0.25	260	—	100	*URZ2G100MHD
	22	18 \times 15	0.25	452	—	200	*URZ2G220MHD
	22	16 \times 20	0.25	452	—	200	*URZ2G220MHD6
	33	18 \times 20	0.25	628	—	250	*URZ2G330MHD
	47	18 \times 25	0.25	852	—	300	*URZ2G470MHD

For cut leads, formed leads or taped parts, please add the appropriate code after the size code (12th digit).
If there is no size code in the part number, please add size code "1" and then add the appropriate code.

- For formed lead or taped product specifications and minimum order quantity, please refer to the Guidelines for Aluminum Electrolytic Capacitors.

UVP

Bi-Polarized



- Standard bi-polarized series for entertainment electronics.
- Compliant to the RoHS directive (2011/65/EU,(EU)2015/863).

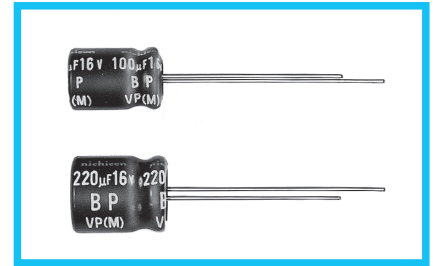
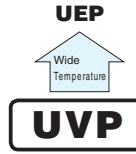

Specifications

Item	Performance Characteristics																													
Category Temperature Range	-40 to +85°C																													
Rated Voltage Range	6.3 to 100V																													
Rated Capacitance Range	10 to 6800µF																													
Capacitance Tolerance	±20% at 120Hz, 20°C																													
Leakage Current ※	After 5 minutes' application of rated voltage at 20°C, leakage current is not more than 0.03CV(µA).																													
Tangent of loss angle (tan δ)	For capacitance of more than 1000µF, add 0.02 for every increase of 1000µF. Measurement frequency : 120Hz at 20°C <table border="1"> <tr> <td>Rated voltage (V)</td> <td>6.3</td> <td>10</td> <td>16</td> <td>25</td> <td>35</td> <td>50</td> <td>63</td> <td>100</td> </tr> <tr> <td>tan δ (max.)</td> <td>0.26</td> <td>0.24</td> <td>0.22</td> <td>0.20</td> <td>0.16</td> <td>0.14</td> <td>0.12</td> <td>0.10</td> </tr> </table>	Rated voltage (V)	6.3	10	16	25	35	50	63	100	tan δ (max.)	0.26	0.24	0.22	0.20	0.16	0.14	0.12	0.10											
Rated voltage (V)	6.3	10	16	25	35	50	63	100																						
tan δ (max.)	0.26	0.24	0.22	0.20	0.16	0.14	0.12	0.10																						
Stability at Low Temperature	Measurement frequency : 120Hz <table border="1"> <tr> <td colspan="2">Rated voltage (V)</td> <td>6.3</td> <td>10</td> <td>16</td> <td>25</td> <td>35</td> <td>50</td> <td>63</td> <td>100</td> </tr> <tr> <td rowspan="2">Impedance ratio (max.)</td> <td>Z(-25°C) / Z(+20°C)</td> <td>4</td> <td>3</td> <td>2</td> <td>2</td> <td>2</td> <td>2</td> <td>2</td> <td>2</td> </tr> <tr> <td>Z(-40°C) / Z(+20°C)</td> <td>10</td> <td>8</td> <td>6</td> <td>5</td> <td>4</td> <td>4</td> <td>3</td> <td>3</td> </tr> </table>	Rated voltage (V)		6.3	10	16	25	35	50	63	100	Impedance ratio (max.)	Z(-25°C) / Z(+20°C)	4	3	2	2	2	2	2	2	Z(-40°C) / Z(+20°C)	10	8	6	5	4	4	3	3
Rated voltage (V)		6.3	10	16	25	35	50	63	100																					
Impedance ratio (max.)	Z(-25°C) / Z(+20°C)	4	3	2	2	2	2	2	2																					
	Z(-40°C) / Z(+20°C)	10	8	6	5	4	4	3	3																					
Endurance	The specifications listed at right shall be met when the capacitors are restored to 20°C after the rated voltage is applied for 2000 hours at 85°C with the polarity inverted every 250 hours. <table border="1"> <tr> <td>Capacitance change</td> <td>Within ±20% of the initial capacitance value</td> </tr> <tr> <td>tan δ</td> <td>200% or less than the initial specified value</td> </tr> <tr> <td>Leakage current</td> <td>Less than or equal to the initial specified value</td> </tr> </table>	Capacitance change	Within ±20% of the initial capacitance value	tan δ	200% or less than the initial specified value	Leakage current	Less than or equal to the initial specified value																							
Capacitance change	Within ±20% of the initial capacitance value																													
tan δ	200% or less than the initial specified value																													
Leakage current	Less than or equal to the initial specified value																													
Shelf Life	After storing the capacitors under no load at 85°C for 1000 hours and then performing voltage treatment based on JIS C 5101-4 clause 4.1 at 20°C, they shall meet the specified values for the endurance characteristics listed above.																													
Marking	Printed with white color letter on black sleeve.																													

※ I : Leakage Current (µA), C : Rated Capacitance (µF), V : Rated Voltage (V)

Radial Lead Type

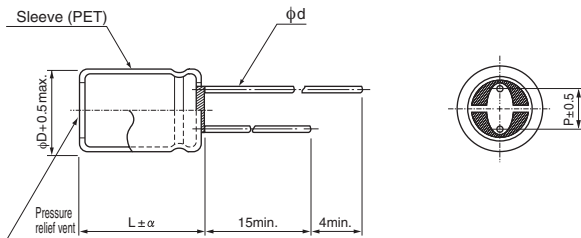

α	(L < 20) 1.5 (L ≥ 20) 2.0	(mm)				
		φD	8	10	12.5	16
P		3.5	5.0	5.0	7.5	7.5
φd		0.6	0.6	0.6	0.8	0.8

- Please refer to the Guidelines for Aluminum Electrolytic Capacitors for end seal configuration information.

Frequency coefficient of rated ripple current

Cap.(µF)	Frequency	50 Hz	120 Hz	300 Hz	1 kHz	10 kHz or more
10 to 47		0.75	1.00	1.35	1.57	2.00
100 to 470		0.80	1.00	1.23	1.34	1.50
1000 to 6800		0.85	1.00	1.10	1.13	1.15

Type numbering system (Example : 10V 470µF)

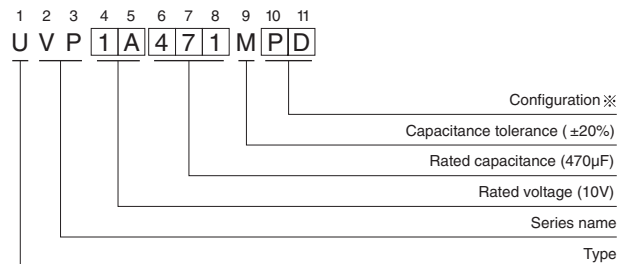

※ Configuration

φ D	Pb-free leadwire Pb-free PET sleeve
8 - 10	PD
12.5 to 18	HD

● Dimension table in next page.

UVP

■ Dimensions

Rated Voltage (V) (code)	Rated Capacitance (μF)	Case Size φD×L (mm)	tan δ	Leakage Current (μA) (at 20°C after 5 minutes)	Rated Ripple (mArms) (85°C/120Hz)	Part Number
6.3 (0J)	220	8×11.5	0.26	41.58	215	UVP0J221MPD
	330	8×11.5	0.26	62.37	265	UVP0J331MPD
	470	10×12.5	0.26	88.83	370	UVP0J471MPD
	1000	10×20	0.26	189	650	UVP0J102MPD
	2200	12.5×25	0.28	415.8	1160	UVP0J222MHD
	3300	16×25	0.30	623.7	1570	UVP0J332MHD
	4700	16×30.5	0.32	888.3	2020	UVP0J472MHD
	6800	18×35.5	0.36	1285.2	2600	UVP0J682MHD
10 (1A)	220	8×11.5	0.24	66	215	UVP1A221MPD
	330	10×16	0.24	99	345	UVP1A331MPD
	470	10×16	0.24	141	410	UVP1A471MPD
	1000	12.5×20	0.24	300	720	UVP1A102MHD
	2200	16×25	0.26	660	1280	UVP1A222MHD
	3300	16×30.5	0.28	990	1690	UVP1A332MHD
	4700	18×35.5	0.30	1410	2160	UVP1A472MHD
16 (1C)	100	8×11.5	0.22	48	160	UVP1C101MPD
	220	10×12.5	0.22	105.6	275	UVP1C221MPD
	330	10×16	0.22	158.4	375	UVP1C331MPD
	470	10×20	0.22	225.6	485	UVP1C471MPD
	1000	12.5×25	0.22	480	855	UVP1C102MHD
	2200	16×30.5	0.24	1056	1510	UVP1C222MHD
	3300	18×35.5	0.26	1584	1980	UVP1C332MHD
25 (1E)	100	8×11.5	0.20	75	160	UVP1E101MPD
	220	10×16	0.20	165	305	UVP1E221MPD
	330	12.5×20	0.20	247.5	450	UVP1E331MHD
	470	12.5×20	0.20	352.5	540	UVP1E471MHD
	1000	16×25	0.20	750	950	UVP1E102MHD
	2200	18×35.5	0.22	1650	1620	UVP1E222MHD
35 (1V)	33	8×11.5	0.16	34.65	100	UVP1V330MPD
	47	8×11.5	0.16	49.35	120	UVP1V470MPD
	100	10×16	0.16	105	230	UVP1V101MPD
	220	12.5×20	0.16	231	410	UVP1V221MHD
	330	12.5×20	0.16	346.5	505	UVP1V331MHD
	470	12.5×25	0.16	493.5	655	UVP1V471MHD
	1000	16×30.5	0.16	1050	1140	UVP1V102MHD
50 (1H)	22	8×11.5	0.14	33	89	UVP1H220MPD
	33	8×11.5	0.14	49.5	105	UVP1H330MPD
	47	10×12.5	0.14	70.5	150	UVP1H470MPD
	100	10×20	0.14	150	265	UVP1H101MPD
	220	12.5×25	0.14	330	480	UVP1H221MHD
	330	16×25	0.14	495	650	UVP1H331MHD
	470	16×30.5	0.14	705	835	UVP1H471MHD

For cut leads, formed leads or taped parts, please add the appropriate code after the size code (12th digit).
If there is no size code in the part number, please add size code "1" and then add the appropriate code.

UVP

■ Dimensions

Rated Voltage (V) (code)	Rated Capacitance (μF)	Case Size φD×L (mm)	tan δ	Leakage Current (μA) (at 20°C after 5 minutes)	Rated Ripple (mArms) (85°C/120Hz)	Part Number
63 (1J)	22	8×11.5	0.12	41.58	95	UVP1J220MPD
	33	10×12.5	0.12	62.37	135	UVP1J330MPD
	47	10×16	0.12	88.83	180	UVP1J470MPD
	100	12.5×20	0.12	189	320	UVP1J101MHD
	220	16×25	0.12	415.8	575	UVP1J221MHD
	330	16×30.5	0.12	623.7	655	UVP1J331MHD
	470	18×35.5	0.12	888.3	965	UVP1J471MHD
100 (2A)	10	8×11.5	0.10	30	71	UVP2A100MPD
	22	10×16	0.10	66	135	UVP2A220MPD
	33	12.5×20	0.10	99	220	UVP2A330MHD
	47	12.5×20	0.10	141	240	UVP2A470MHD
	100	16×25	0.10	300	425	UVP2A101MHD
	220	18×35.5	0.10	660	720	UVP2A221MHD

For cut leads, formed leads or taped parts, please add the appropriate code after the size code (12th digit).
 If there is no size code in the part number, please add size code "1" and then add the appropriate code.

- For formed lead or taped product specifications and minimum order quantity, please refer to the Guidelines for Aluminum Electrolytic Capacitors.

UEP

Bi-Polarized, Wide Temperature Range



Bi-polarized

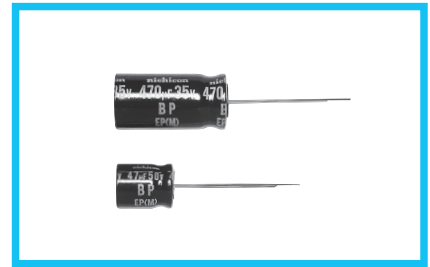

- Bi-polarized series for operations over wide temperature range of -55°C to +105°C.
- Compliant to the RoHS directive (2011/65/EU, (EU)2015/863).

Specifications

Item	Performance Characteristics																									
Category Temperature Range	-55 to +105°C																									
Rated Voltage Range	6.3 to 100V																									
Rated Capacitance Range	10 to 6800µF																									
Capacitance Tolerance	±20% at 120Hz, 20°C																									
Leakage Current ※	After 5 minutes' application of rated voltage at 20°C, leakage current is not more than 0.03CV(µA).																									
Tangent of loss angle (tan δ)	Measurement frequency : 120Hz, Temperature : 20°C																									
	Rated voltage (V)	6.3	10	16	25	35	50	63	100																	
	tan δ (max.)	0.24	0.24	0.20	0.20	0.16	0.14	0.12	0.10																	
Stability at Low Temperature	Measurement frequency : 120Hz																									
	Rated voltage (V)	6.3	10	16	25	35	50	63	100																	
	Impedance ratio	Z(-25°C) / Z(+20°C)	4	3	2	2	2	2	2	2																
	(max.)	Z(-40°C) / Z(+20°C)	10	8	6	4	3	3	3	3																
Endurance	The specifications listed at right shall be met when the capacitors are restored to 20°C after the rated voltage is applied for 1000 hours at 105°C with the polarity inverted every 250 hours.						<table border="1"> <tr> <td>Capacitance change</td> <td colspan="3">Within ±25% of the initial capacitance value (6.3to16V)</td> </tr> <tr> <td>tan δ</td> <td colspan="3">Within ±20% of the initial capacitance value (25to100V)</td> </tr> <tr> <td>Leakage current</td> <td colspan="3">150% or less than the initial specified value</td> </tr> <tr> <td></td> <td colspan="3">Less than or equal to the initial specified value</td> </tr> </table>				Capacitance change	Within ±25% of the initial capacitance value (6.3to16V)			tan δ	Within ±20% of the initial capacitance value (25to100V)			Leakage current	150% or less than the initial specified value				Less than or equal to the initial specified value		
	Capacitance change	Within ±25% of the initial capacitance value (6.3to16V)																								
tan δ	Within ±20% of the initial capacitance value (25to100V)																									
Leakage current	150% or less than the initial specified value																									
	Less than or equal to the initial specified value																									
Shelf Life	After storing the capacitors under no load at 105°C for 1000 hours and then performing voltage treatment based on JIS C 5101-4 clause 4.1 at 20°C, they shall meet the specified values for the endurance characteristics listed above.																									
Marking	Printed with white color letter on black sleeve.																									

※ I : Leakage Current (µA), C : Rated Capacitance (µF), V : Rated Voltage (V)

Radial Lead Type

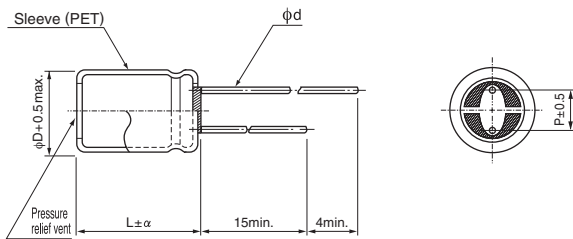

α		(mm)				
α	(L < 20)	1.5				
	(L ≥ 20)	2.0				
φD		8	10	12.5	16	18
P		3.5	5.0	5.0	7.5	7.5
φd		0.6	0.6	0.6	0.8	0.8

- Please refer to the Guidelines for Aluminum Electrolytic Capacitors for end seal configuration information.

Type numbering system (Example : 10V 470µF)

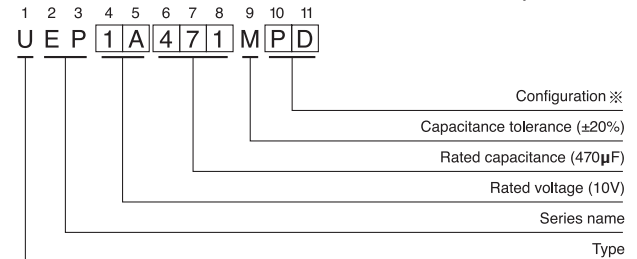

※ Configuration

φ D	Pb-free leadwire Pb-free PET sleeve
8 · 10	PD
12.5 to 18	HD

Frequency coefficient of rated ripple current

Cap.(µF)	Frequency	50 Hz	120Hz	300 Hz	1 kHz	10 kHz or more
10 to 47		0.75	1.00	1.35	1.57	2.00
100 to 470		0.80	1.00	1.23	1.34	1.50
1000 to 6800		0.85	1.00	1.10	1.13	1.15

• Dimension table in next page.

UEP

■ Dimensions

Rated Voltage (V) (code)	Rated Capacitance (μF)	Case Size φD×L (mm)	tan δ	Leakage Current (μA) (at 20°C after 5 minutes)	Rated Ripple (mArms) (105°C/120Hz)	Part Number
6.3 (0J)	220	8×11.5	0.24	41.58	150	UEP0J221MPD
	330	8×11.5	0.24	62.37	185	UEP0J331MPD
	470	10×12.5	0.24	88.83	260	UEP0J471MPD
	1000	10×20	0.24	189	460	UEP0J102MPD
	2200	12.5×25	0.26	415.8	820	UEP0J222MHD
	3300	16×25	0.28	623.7	1110	UEP0J332MHD
	4700	16×30.5	0.30	888.3	1430	UEP0J472MHD
10 (1A)	6800	18×35.5	0.34	1285.2	1830	UEP0J682MHD
	220	8×11.5	0.24	66	150	UEP1A221MPD
	330	10×16	0.24	99	240	UEP1A331MPD
	470	10×16	0.24	141	290	UEP1A471MPD
	1000	12.5×20	0.24	300	510	UEP1A102MHD
	2200	16×25	0.26	660	910	UEP1A222MHD
	3300	16×30.5	0.28	990	1200	UEP1A332MHD
16 (1C)	4700	18×35.5	0.30	1410	1520	UEP1A472MHD
	100	8×11.5	0.20	48	110	UEP1C101MPD
	220	10×12.5	0.20	105.6	195	UEP1C221MPD
	330	10×16	0.20	158.4	265	UEP1C331MPD
	470	10×20	0.20	225.6	345	UEP1C471MPD
	1000	12.5×25	0.20	480	605	UEP1C102MHD
	2200	16×30.5	0.22	1056	1070	UEP1C222MHD
25 (1E)	3300	18×35.5	0.24	1584	1400	UEP1C332MHD
	100	8×11.5	0.20	75	110	UEP1E101MPD
	220	10×16	0.20	165	215	UEP1E221MPD
	330	12.5×20	0.20	247.5	320	UEP1E331MHD
	470	12.5×20	0.20	352.5	380	UEP1E471MHD
	1000	16×25	0.20	750	670	UEP1E102MHD
	2200	18×35.5	0.22	1650	1140	UEP1E222MHD
35 (1V)	3300	18×35.5	0.22	1650	1140	UEP1E222MHD
	33	8×11.5	0.16	34.65	72	UEP1V330MPD
	47	8×11.5	0.16	49.35	86	UEP1V470MPD
	100	10×16	0.16	105	160	UEP1V101MPD
	220	12.5×20	0.16	231	290	UEP1V221MHD
	330	12.5×20	0.16	346.5	350	UEP1V331MHD
	470	12.5×25	0.16	493.5	465	UEP1V471MHD
1000	16×30.5	0.16	1050	805	UEP1V102MHD	

For cut leads, formed leads or taped parts, please add the appropriate code after the size code (12th digit).
If there is no size code in the part number, please add size code "1" and then add the appropriate code.

UEP

■ Dimensions

Rated Voltage (V) (code)	Rated Capacitance (μ F)	Case Size ϕ D \times L (mm)	$\tan \delta$	Leakage Current (μ A) (at 20°C after 5 minutes)	Rated Ripple (mArms) (105°C/120Hz)	Part Number
50 (1H)	22	8 \times 11.5	0.14	33	63	UEP1H220MPD
	33	8 \times 11.5	0.14	49.5	77	UEP1H330MPD
	47	10 \times 12.5	0.14	70.5	105	UEP1H470MPD
	100	10 \times 20	0.14	150	190	UEP1H101MPD
	220	12.5 \times 25	0.14	330	340	UEP1H221MHD
	330	16 \times 25	0.14	495	460	UEP1H331MHD
	470	16 \times 30.5	0.14	705	590	UEP1H471MHD
63 (1J)	22	8 \times 11.5	0.12	41.58	68	UEP1J220MPD
	33	10 \times 12.5	0.12	62.37	98	UEP1J330MPD
	47	10 \times 16	0.12	88.83	130	UEP1J470MPD
	100	12.5 \times 20	0.12	189	225	UEP1J101MHD
	220	16 \times 25	0.12	415.8	405	UEP1J221MHD
	330	16 \times 30.5	0.12	623.7	535	UEP1J331MHD
	470	18 \times 35.5	0.12	888.3	680	UEP1J471MHD
100 (2A)	10	8 \times 11.5	0.10	30	50	UEP2A100MPD
	22	10 \times 16	0.10	66	97	UEP2A220MPD
	33	12.5 \times 20	0.10	99	140	UEP2A330MHD
	47	12.5 \times 20	0.10	141	170	UEP2A470MHD
	100	16 \times 25	0.10	300	300	UEP2A101MHD
	220	18 \times 35.5	0.10	660	510	UEP2A221MHD

For cut leads, formed leads or taped parts, please add the appropriate code after the size code (12th digit).
If there is no size code in the part number, please add size code "1" and then add the appropriate code.

- For formed lead or taped product specifications and minimum order quantity, please refer to the Guidelines for Aluminum Electrolytic Capacitors.

ALUMINUM ELECTROLYTIC CAPACITORS

UPM

Low Impedance, High Reliability



Low Impedance Long Life

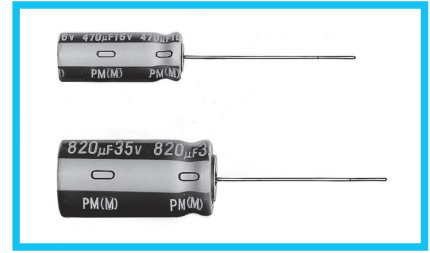

- High reliability withstanding 5000 hour load life at +105°C (3000 hours for smaller case sizes as specified below).
- Capacitance ranges available based on the numerical values in E12 series under JIS.
- Compliant to the RoHS directive (2011/65/EU,(EU)2015/863).
- AEC-Q200 Qualified. Please contact us for details.

Specifications

Item	Performance Characteristics	
Category Temperature Range	-55 to +105°C	
Rated Voltage Range	6.3 to 100V	
Rated Capacitance Range	22 to 15000µF	
Capacitance Tolerance	±20% at 120Hz, 20°C	
Leakage Current ※	After 1 minute's application of rated voltage at 20°C, leakage current is not more than 0.03CV(µA).	
Tangent of loss angle (tan δ)	For capacitance of more than 1000µF, add 0.02 for every increase of 1000µF. Measurement frequency : 120Hz at 20°C	
	Rated Voltage (V)	6.3 10 16 25 35 50 63 to 100
	tan δ (max.)	0.22 0.19 0.16 0.14 0.12 0.10 0.08
Stability at Low Temperature	Rated voltage (V)	6.3 · 10 16 25 · 35 50 to 100
	Impedance ratio (max.)	Z(-55°C) / Z(+20°C)
		4 3 3 2
Endurance	The specifications listed below shall be met when the capacitors are restored to 20°C after D.C. bias plus rated ripple current is applied at 105°C for the condition listed at right. The peak voltage shall not exceed the rated voltage.	
	Rated Voltage	φD(mm) φ8 ≥φ10
	6.3~100V	3000hrs. 5000hrs.
	Capacitance change	Within ±20% of the initial capacitance value
	tan δ	200% or less than the initial specified value
	Leakage current	Less than or equal to the initial specified value
Shelf Life	After storing the capacitors under no load at 105°C for 1000 hours and then performing voltage treatment based on JIS C 5101-4 clause 4.1 at 20°C, they shall meet the characteristic requirements listed at right.	
	Capacitance change	Within ±20% of the initial capacitance value
	tan δ	150% or less than the initial specified value
	Leakage current	Less than or equal to the initial specified value
Marking	Printed with white color letter on dark brown sleeve.	

※ I : Leakage Current (µA), C : Rated Capacitance (µF), V : Rated Voltage (V)

Radial Lead Type

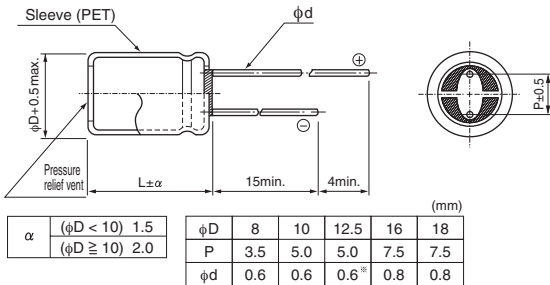

※In case L > 25 for the φ12.5 dia. unit, lead dia. φ d = 0.8mm.

- Please refer to the Guidelines for Aluminum Electrolytic Capacitors for end seal configuration information.

Type numbering system (Example : 25V 470µF)

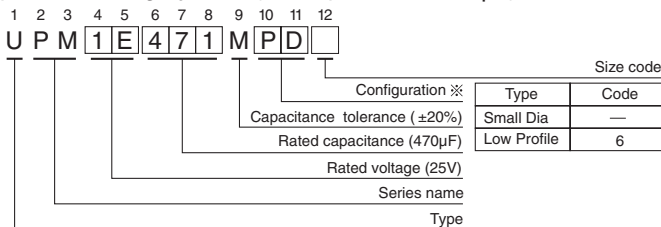

※ Configuration

φ D	Pb-free leadwire Pb-free PET sleeve
8 · 10	PD
12.5 to 18	HD

Frequency coefficient of rated ripple current

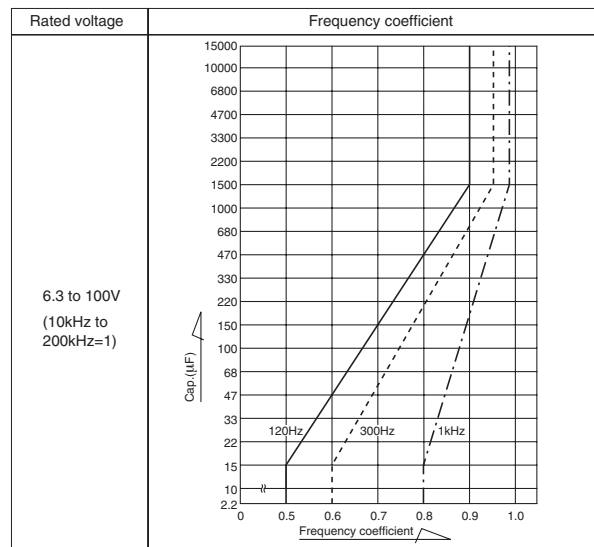

● Dimension table in next page.



■ Dimensions

Rated Voltage (V) (code)	Rated Capacitance (μF)	Case Size φD×L (mm)	tan δ	Leakage Current (μA) (at 20°C after 1 minute)	Impedance (Ω) max.		Rated Ripple (mArms)		Part Number
					20°C/100kHz	-10°C/100kHz	105°C/10 to 200kHz	105°C/120Hz	
6.3 (0J)	390	8×11.5	0.22	73.71	0.17	0.34	445	345	UPM0J391MPD
	470	8×15	0.22	88.83	0.14	0.28	550	440	UPM0J471MPD
	470	10×12.5	0.22	88.83	0.14	0.28	635	505	UPM0J471MPD6
	560	8×15	0.22	105.84	0.12	0.24	595	485	UPM0J561MPD
	560	10×12.5	0.22	105.84	0.13	0.26	670	545	UPM0J561MPD6
	680	8×20	0.22	128.52	0.10	0.20	730	605	UPM0J681MPD
	680	10×16	0.22	128.52	0.11	0.22	825	685	UPM0J681MPD6
	820	8×20	0.22	154.98	0.085	0.17	795	675	UPM0J821MPD
	820	10×16	0.22	154.98	0.095	0.19	840	715	UPM0J821MPD6
	1000	10×20	0.22	189	0.075	0.15	950	820	UPM0J102MPD
	1000	12.5×15	0.22	189	0.085	0.17	890	770	UPM0J102MHD6
	1200	10×20	0.22	226.8	0.065	0.13	1060	930	UPM0J122MPD
	1200	12.5×15	0.22	226.8	0.075	0.15	950	835	UPM0J122MHD6
	1500	10×25	0.22	283.5	0.055	0.11	1260	1130	UPM0J152MPD
	1500	12.5×15	0.22	283.5	0.065	0.13	1020	915	UPM0J152MHD6
	1800	10×30.5	0.22	340.2	0.050	0.10	1370	1230	UPM0J182MPD
	1800	16×15	0.22	340.2	0.055	0.11	1270	1140	UPM0J182MHD6
	2200	10×30.5	0.24	415.8	0.043	0.086	1470	1320	UPM0J222MPD
	2200	16×15	0.24	415.8	0.049	0.098	1340	1200	UPM0J222MHD6
	2700	12.5×25	0.24	510.3	0.038	0.076	1700	1530	UPM0J272MHD
	2700	18×15	0.24	510.3	0.044	0.088	1500	1350	UPM0J272MHD6
	3300	12.5×25	0.26	623.7	0.034	0.068	1710	1530	UPM0J332MHD
	3300	18×15	0.26	623.7	0.039	0.078	1600	1440	UPM0J332MHD6
	3900	12.5×30.5	0.26	737.1	0.031	0.062	1980	1780	UPM0J392MHD
	3900	16×20	0.26	737.1	0.036	0.072	1770	1590	UPM0J392MHD6
	4700	12.5×35.5	0.28	888.3	0.028	0.056	2230	2000	UPM0J472MHD
	4700	18×20	0.28	888.3	0.032	0.064	1920	1720	UPM0J472MHD6
	5600	12.5×40	0.30	1058.4	0.026	0.052	2460	2210	UPM0J562MHD
	5600	18×20	0.30	1058.4	0.030	0.060	1980	1780	UPM0J562MHD6
	6800	16×30.5	0.32	1285.2	0.024	0.048	2510	2250	UPM0J682MHD
	6800	18×25	0.32	1285.2	0.027	0.054	2350	2110	UPM0J682MHD6
	8200	16×35.5	0.36	1549.8	0.022	0.044	2770	2490	UPM0J822MHD
	8200	18×30.5	0.36	1549.8	0.025	0.050	2600	2340	UPM0J822MHD6
10000	16×40	0.40	1890	0.020	0.040	3110	2790	UPM0J103MHD	
10000	18×30.5	0.40	1890	0.023	0.046	2720	2440	UPM0J103MHD6	
12000	18×35.5	0.44	2268	0.019	0.038	3050	2740	UPM0J123MHD	
15000	18×40	0.50	2835	0.018	0.036	3300	2970	UPM0J153MHD	

For cut leads, formed leads or taped parts, please add the appropriate code after the size code (12th digit).
 If there is no size code in the part number, please add size code "1" and then add the appropriate code.

UPM

■ Dimensions

Rated Voltage (V) (code)	Rated Capacitance (μF)	Case Size φD×L (mm)	tan δ	Leakage Current (μA) (at 20°C after 1 minute)	Impedance (Ω) max.		Rated Ripple (mA _{rms})		Part Number
					20°C/ 100kHz	-10°C/ 100kHz	105°C/ 10 to 200kHz	105°C/ 120Hz	
10 (1A)	330	8×11.5	0.19	99	0.16	0.32	460	350	UPM1A331MPD
	390	8×15	0.19	117	0.14	0.28	550	430	UPM1A391MPD
	390	10×12.5	0.19	117	0.15	0.30	635	490	UPM1A391MPD6
	470	8×15	0.19	141	0.12	0.24	595	475	UPM1A471MPD
	470	10×12.5	0.19	141	0.13	0.26	670	535	UPM1A471MPD6
	560	8×20	0.19	168	0.10	0.20	730	595	UPM1A561MPD
	560	10×16	0.19	168	0.11	0.22	700	570	UPM1A561MPD6
	680	8×20	0.19	204	0.085	0.17	795	660	UPM1A681MPD
	680	10×16	0.19	204	0.090	0.18	825	685	UPM1A681MPD6
	820	10×20	0.19	246	0.070	0.14	985	835	UPM1A821MPD
	820	12.5×15	0.19	246	0.080	0.16	920	780	UPM1A821MHD6
	1000	10×20	0.19	300	0.060	0.12	1060	915	UPM1A102MPD
	1000	12.5×15	0.19	300	0.065	0.13	1040	900	UPM1A102MHD6
	1200	10×25	0.19	360	0.050	0.10	1260	1120	UPM1A122MPD
	1200	12.5×15	0.19	360	0.060	0.12	1060	930	UPM1A122MHD6
	1500	10×30.5	0.19	450	0.045	0.09	1450	1300	UPM1A152MPD
	1500	16×15	0.19	450	0.050	0.10	1330	1190	UPM1A152MHD6
	1800	12.5×20	0.19	540	0.039	0.078	1470	1320	UPM1A182MHD
	1800	16×15	0.19	540	0.044	0.088	1420	1270	UPM1A182MHD6
	2200	12.5×25	0.21	660	0.034	0.068	1710	1530	UPM1A222MHD
	2200	18×15	0.21	660	0.039	0.078	1600	1440	UPM1A222MHD6
	2700	12.5×30.5	0.21	810	0.030	0.060	1980	1780	UPM1A272MHD
	2700	16×20	0.21	810	0.035	0.070	1740	1560	UPM1A272MHD6
	3300	12.5×35.5	0.23	990	0.026	0.052	2230	2000	UPM1A332MHD
	3300	16×20	0.23	990	0.031	0.062	1850	1660	UPM1A332MHD6
	3900	12.5×40	0.23	1170	0.024	0.048	2460	2210	UPM1A392MHD
	3900	18×20	0.23	1170	0.028	0.056	2050	1840	UPM1A392MHD6
	4700	16×30.5	0.25	1410	0.023	0.046	2420	2170	UPM1A472MHD
	4700	18×25	0.25	1410	0.026	0.052	2350	2110	UPM1A472MHD6
	5600	16×35.5	0.27	1680	0.021	0.042	2610	2340	UPM1A562MHD
5600	18×25	0.27	1680	0.024	0.048	2440	2190	UPM1A562MHD6	
6800	16×35.5	0.29	2040	0.020	0.040	2770	2490	UPM1A682MHD	
6800	18×30.5	0.29	2040	0.022	0.044	2720	2440	UPM1A682MHD6	
8200	16×40	0.33	2460	0.019	0.038	3110	2790	UPM1A822MHD	
8200	18×35.5	0.33	2460	0.021	0.042	3050	2740	UPM1A822MHD6	
10000	18×40	0.37	3000	0.017	0.034	3300	2970	UPM1A103MHD	
16 (1C)	220	8×11.5	0.16	105.6	0.16	0.32	460	335	UPM1C221MPD
	270	8×15	0.16	129.6	0.14	0.28	550	410	UPM1C271MPD
	270	10×12.5	0.16	129.6	0.14	0.28	635	470	UPM1C271MPD6
	330	8×15	0.16	158.4	0.12	0.24	595	455	UPM1C331MPD
	330	10×12.5	0.16	158.4	0.12	0.24	670	510	UPM1C331MPD6
	390	8×20	0.16	187.2	0.10	0.20	730	570	UPM1C391MPD

For cut leads, formed leads or taped parts, please add the appropriate code after the size code (12th digit).
If there is no size code in the part number, please add size code "1" and then add the appropriate code.

UPM

■ Dimensions

Rated Voltage (V) (code)	Rated Capacitance (μF)	Case Size φD×L (mm)	tan δ	Leakage Current (μA) (at 20°C after 1 minute)	Impedance (Ω) max.		Rated Ripple (mArms)		Part Number
					20°C/100kHz	-10°C/100kHz	105°C/10 to 200kHz	105°C/120Hz	
16 (1C)	390	10×16	0.16	187.2	0.10	0.20	730	570	UPM1C391MPD6
	470	8×20	0.16	225.6	0.090	0.18	770	615	UPM1C471MPD
	470	10×16	0.16	225.6	0.090	0.18	825	660	UPM1C471MPD6
	560	10×20	0.16	268.8	0.075	0.15	950	775	UPM1C561MPD
	560	12.5×15	0.16	268.8	0.080	0.16	920	750	UPM1C561MHD6
	680	10×20	0.16	326.4	0.065	0.13	1060	880	UPM1C681MPD
	680	12.5×15	0.16	326.4	0.070	0.14	985	820	UPM1C681MHD6
	820	10×25	0.16	393.6	0.055	0.11	1260	1070	UPM1C821MPD
	820	12.5×15	0.16	393.6	0.060	0.12	1060	900	UPM1C821MHD6
	1000	10×30.5	0.16	480	0.047	0.094	1410	1220	UPM1C102MPD
	1000	16×15	0.16	480	0.055	0.11	1270	1100	UPM1C102MHD6
	1200	12.5×20	0.16	576	0.041	0.082	1430	1250	UPM1C122MHD
	1200	16×15	0.16	576	0.046	0.092	1390	1220	UPM1C122MHD6
	1500	12.5×25	0.16	720	0.036	0.072	1700	1530	UPM1C152MHD
	1500	18×15	0.16	720	0.041	0.082	1560	1400	UPM1C152MHD6
	1800	12.5×30.5	0.16	864	0.032	0.064	1880	1690	UPM1C182MHD
	1800	16×20	0.16	864	0.037	0.074	1700	1530	UPM1C182MHD6
	2200	12.5×30.5	0.18	1056	0.028	0.056	2010	1800	UPM1C222MHD
	2200	16×20	0.18	1056	0.033	0.066	1800	1620	UPM1C222MHD6
	2700	12.5×35.5	0.18	1296	0.025	0.050	2230	2000	UPM1C272MHD
	2700	16×25	0.18	1296	0.030	0.060	2190	1970	UPM1C272MHD6
	3300	12.5×40	0.20	1584	0.023	0.046	2460	2210	UPM1C332MHD
	3300	18×20	0.20	1584	0.027	0.054	2090	1880	UPM1C332MHD6
	3900	16×30.5	0.20	1872	0.022	0.044	2510	2250	UPM1C392MHD
	3900	18×25	0.20	1872	0.025	0.050	2350	2110	UPM1C392MHD6
	4700	16×35.5	0.22	2256	0.020	0.040	2770	2490	UPM1C472MHD
	4700	18×30.5	0.22	2256	0.023	0.046	2720	2440	UPM1C472MHD6
	5600	16×40	0.24	2688	0.019	0.038	3110	2790	UPM1C562MHD
5600	18×35.5	0.24	2688	0.022	0.044	2620	2350	UPM1C562MHD6	
6800	18×35.5	0.26	3264	0.018	0.036	3050	2740	UPM1C682MHD	
8200	18×40	0.30	3936	0.017	0.034	3300	2970	UPM1C822MHD	
25 (1E)	150	8×11.5	0.14	112.5	0.16	0.32	460	320	UPM1E151MPD
	180	8×15	0.14	135	0.14	0.28	550	390	UPM1E181MPD
	180	10×12.5	0.14	135	0.15	0.30	635	450	UPM1E181MPD6
	220	8×15	0.14	165	0.11	0.22	625	455	UPM1E221MPD
	220	10×12.5	0.14	165	0.13	0.26	670	485	UPM1E221MPD6
	270	8×20	0.14	202.5	0.095	0.19	750	560	UPM1E271MPD
	270	10×16	0.14	202.5	0.11	0.22	700	525	UPM1E271MPD6
	330	8×20	0.14	247.5	0.085	0.17	795	610	UPM1E331MPD
	330	10×16	0.14	247.5	0.095	0.19	825	630	UPM1E331MPD6
	390	10×20	0.14	292.5	0.070	0.14	985	770	UPM1E391MPD
	390	12.5×15	0.14	292.5	0.080	0.16	920	720	UPM1E391MHD6
	470	10×20	0.14	352.5	0.065	0.13	1060	845	UPM1E471MPD

For cut leads, formed leads or taped parts, please add the appropriate code after the size code (12th digit).
 If there is no size code in the part number, please add size code "1" and then add the appropriate code.

UPM

■ Dimensions

Rated Voltage (V) (code)	Rated Capacitance (μ F)	Case Size ϕ D×L(mm)	tan δ	Leakage Current (μ A) (at 20°C after 1 minute)	Impedance (Ω) max.		Rated Ripple (mA _{rms})		Part Number
					20°C/ 100kHz	-10°C/ 100kHz	105°C/ 10 to 200kHz	105°C/ 120Hz	
25 (1E)	470	12.5×15	0.14	352.5	0.070	0.14	985	785	UPM1E471MHD6
	560	10×25	0.14	420	0.055	0.11	1260	1030	UPM1E561MPD
	560	12.5×15	0.14	420	0.060	0.12	1060	860	UPM1E561MHD6
	680	10×30.5	0.14	510	0.046	0.092	1420	1180	UPM1E681MPD
	680	16×15	0.14	510	0.055	0.11	1270	1050	UPM1E681MHD6
	820	12.5×20	0.14	615	0.041	0.082	1440	1220	UPM1E821MHD
	820	16×15	0.14	615	0.049	0.098	1340	1140	UPM1E821MHD6
	1000	12.5×25	0.14	750	0.036	0.072	1700	1470	UPM1E102MHD
	1000	18×15	0.14	750	0.043	0.086	1520	1310	UPM1E102MHD6
	1200	12.5×25	0.14	900	0.032	0.064	1760	1550	UPM1E122MHD
	1200	18×15	0.14	900	0.039	0.078	1600	1400	UPM1E122MHD6
	1500	12.5×30.5	0.14	1125	0.029	0.058	1980	1780	UPM1E152MHD
	1500	16×20	0.14	1125	0.034	0.068	1770	1590	UPM1E152MHD6
	1800	12.5×35.5	0.14	1350	0.026	0.052	2230	2000	UPM1E182MHD
	1800	16×25	0.14	1350	0.031	0.062	2190	1970	UPM1E182MHD6
	2200	12.5×40	0.16	1650	0.024	0.048	2460	2210	UPM1E222MHD
	2200	18×20	0.16	1650	0.028	0.056	2050	1840	UPM1E222MHD6
	2700	16×30.5	0.16	2025	0.022	0.044	2510	2250	UPM1E272MHD
	2700	18×25	0.16	2025	0.025	0.050	2350	2110	UPM1E272MHD6
	3300	16×35.5	0.18	2475	0.020	0.040	2770	2490	UPM1E332MHD
3300	18×30.5	0.18	2475	0.023	0.046	2720	2440	UPM1E332MHD6	
3900	16×40	0.18	2925	0.019	0.038	3110	2790	UPM1E392MHD	
3900	18×35.5	0.18	2925	0.021	0.042	3050	2740	UPM1E392MHD6	
4700	18×40	0.20	3525	0.018	0.036	3300	2970	UPM1E472MHD	
35 (1V)	100	8×11.5	0.12	105	0.16	0.32	460	305	UPM1V101MPD
	120	8×15	0.12	126	0.14	0.28	550	370	UPM1V121MPD
	120	10×12.5	0.12	126	0.15	0.30	635	425	UPM1V121MPD6
	150	8×15	0.12	157.5	0.12	0.24	595	415	UPM1V151MPD
	150	10×12.5	0.12	157.5	0.12	0.24	680	475	UPM1V151MPD6
	180	8×20	0.12	189	0.10	0.20	730	520	UPM1V181MPD
	180	10×16	0.12	189	0.11	0.22	700	500	UPM1V181MPD6
	220	8×20	0.12	231	0.085	0.17	795	580	UPM1V221MPD
	220	10×16	0.12	231	0.090	0.18	825	600	UPM1V221MPD6
	270	10×20	0.12	283.5	0.070	0.14	985	735	UPM1V271MPD
	270	12.5×15	0.12	283.5	0.080	0.16	920	690	UPM1V271MHD6
	330	10×20	0.12	346.5	0.060	0.12	1060	810	UPM1V331MPD
	330	12.5×15	0.12	346.5	0.065	0.13	1020	780	UPM1V331MHD6
	390	10×25	0.12	409.5	0.055	0.11	1260	980	UPM1V391MPD
	390	12.5×15	0.12	409.5	0.060	0.12	1060	825	UPM1V391MHD6
	470	10×30.5	0.12	493.5	0.046	0.092	1450	1160	UPM1V471MPD
	470	16×15	0.12	493.5	0.055	0.11	1270	1010	UPM1V471MHD6
	560	12.5×20	0.12	588	0.041	0.082	1430	1170	UPM1V561MHD
560	16×15	0.12	588	0.048	0.096	1360	1110	UPM1V561MHD6	

For cut leads, formed leads or taped parts, please add the appropriate code after the size code (12th digit).
If there is no size code in the part number, please add size code "1" and then add the appropriate code.

UPM

■ Dimensions

Rated Voltage (V) (code)	Rated Capacitance (μF)	Case Size φD×L (mm)	tan δ	Leakage Current (μA) (at 20°C after 1 minute)	Impedance (Ω) max.		Rated Ripple (mA _{rms})		Part Number
					20°C/ 100kHz	-10°C/ 100kHz	105°C/ 10 to 200kHz	105°C/ 120Hz	
35 (1V)	680	12.5×25	0.12	714	0.036	0.072	1700	1410	UPM1V681MHD
	680	18×15	0.12	714	0.042	0.084	1540	1280	UPM1V681MHD6
	820	12.5×25	0.12	861	0.032	0.064	1760	1490	UPM1V821MHD
	820	18×15	0.12	861	0.038	0.076	1620	1380	UPM1V821MHD6
	1000	12.5×30.5	0.12	1050	0.029	0.058	1980	1710	UPM1V102MHD
	1000	16×20	0.12	1050	0.034	0.068	1770	1530	UPM1V102MHD6
	1200	12.5×35.5	0.12	1260	0.026	0.052	2230	1960	UPM1V122MHD
	1200	16×25	0.12	1260	0.031	0.062	2190	1920	UPM1V122MHD6
	1500	12.5×40	0.12	1575	0.024	0.048	2460	2210	UPM1V152MHD
	1500	18×20	0.12	1575	0.028	0.056	2050	1840	UPM1V152MHD6
	1800	16×30.5	0.12	1890	0.022	0.044	2510	2250	UPM1V182MHD
	1800	18×25	0.12	1890	0.025	0.050	2350	2110	UPM1V182MHD6
	2200	16×35.5	0.14	2310	0.020	0.040	2770	2490	UPM1V222MHD
	2200	18×30.5	0.14	2310	0.023	0.046	2720	2440	UPM1V222MHD6
	2700	16×40	0.14	2835	0.018	0.036	3110	2790	UPM1V272MHD
	2700	18×35.5	0.14	2835	0.021	0.042	3050	2740	UPM1V272MHD6
3300	18×40	0.16	3465	0.017	0.034	3300	2970	UPM1V332MHD	
50 (1H)	68	8×11.5	0.10	102	0.20	0.40	415	260	UPM1H680MPD
	82	8×15	0.10	123	0.17	0.34	505	320	UPM1H820MPD
	82	10×12.5	0.10	123	0.18	0.36	530	340	UPM1H820MPD6
	100	8×20	0.10	150	0.14	0.28	620	410	UPM1H101MPD
	100	10×16	0.10	150	0.16	0.32	580	385	UPM1H101MPD6
	120	8×20	0.10	180	0.12	0.24	755	510	UPM1H121MPD
	120	10×16	0.10	180	0.13	0.26	755	510	UPM1H121MPD6
	150	10×20	0.10	225	0.10	0.20	820	570	UPM1H151MPD
	150	12.5×15	0.10	225	0.11	0.22	785	545	UPM1H151MHD6
	180	10×20	0.10	270	0.085	0.17	945	670	UPM1H181MPD
	180	12.5×15	0.10	270	0.095	0.19	845	605	UPM1H181MHD6
	220	10×25	0.10	330	0.075	0.15	1150	840	UPM1H221MPD
	220	12.5×15	0.10	330	0.080	0.16	920	670	UPM1H221MHD6
	270	10×30.5	0.10	405	0.065	0.13	1200	900	UPM1H271MPD
	270	16×15	0.10	405	0.070	0.14	1120	840	UPM1H271MHD6
	330	10×30.5	0.10	495	0.055	0.11	1300	995	UPM1H331MPD
	330	16×15	0.10	495	0.060	0.12	1210	925	UPM1H331MHD6
	390	12.5×25	0.10	585	0.048	0.096	1440	1120	UPM1H391MHD
390	16×15	0.10	585	0.055	0.11	1270	990	UPM1H391MHD6	
470	12.5×25	0.10	705	0.044	0.088	1500	1200	UPM1H471MHD	

For cut leads, formed leads or taped parts, please add the appropriate code after the size code (12th digit).
If there is no size code in the part number, please add size code "1" and then add the appropriate code.

UPM

■ Dimensions

Rated Voltage (V) (code)	Rated Capacitance (μ F)	Case Size ϕ D×L (mm)	tan δ	Leakage Current (μ A) (at 20°C after 1 minute)	Impedance (Ω) max.		Rated Ripple (mArms)		Part Number
					20°C/ 100kHz	-10°C/ 100kHz	105°C/ 10 to 200kHz	105°C/ 120Hz	
50 (1H)	470	18×15	0.10	705	0.046	0.092	1470	1170	UPM1H471MHD6
	560	12.5×30.5	0.10	840	0.040	0.080	1720	1410	UPM1H561MHD
	560	16×20	0.10	840	0.044	0.088	1550	1270	UPM1H561MHD6
	680	12.5×35.5	0.10	1020	0.036	0.072	1900	1580	UPM1H681MHD
	680	16×20	0.10	1020	0.040	0.080	1630	1350	UPM1H681MHD6
	820	12.5×40	0.10	1230	0.033	0.066	2120	1800	UPM1H821MHD
	820	18×20	0.10	1230	0.036	0.072	1810	1540	UPM1H821MHD6
	1000	16×30.5	0.10	1500	0.030	0.060	2150	1860	UPM1H102MHD
	1000	18×25	0.10	1500	0.033	0.066	2020	1750	UPM1H102MHD6
	1200	16×35.5	0.10	1800	0.028	0.056	2320	2040	UPM1H122MHD
	1200	18×30.5	0.10	1800	0.031	0.062	2140	1880	UPM1H122MHD6
	1500	16×40	0.10	2250	0.026	0.052	2650	2380	UPM1H152MHD
	1500	18×30.5	0.10	2250	0.029	0.058	2340	2100	UPM1H152MHD6
	1800	18×35.5	0.10	2700	0.025	0.050	2620	2350	UPM1H182MHD
2200	18×40	0.12	3300	0.024	0.048	2790	2510	UPM1H222MHD	
63 (1J)	47	8×11.5	0.08	88.83	0.25	0.50	365	215	UPM1J470MPD
	56	8×15	0.08	105.84	0.21	0.42	450	275	UPM1J560MPD
	56	10×12.5	0.08	105.84	0.23	0.46	450	275	UPM1J560MPD6
	68	8×15	0.08	128.52	0.17	0.34	500	315	UPM1J680MPD
	68	10×12.5	0.08	128.52	0.19	0.38	495	310	UPM1J680MPD6
	82	8×20	0.08	154.98	0.15	0.30	600	385	UPM1J820MPD
	82	10×16	0.08	154.98	0.16	0.32	580	375	UPM1J820MPD6
	100	10×20	0.08	189	0.12	0.24	750	495	UPM1J101MPD
	100	12.5×15	0.08	189	0.14	0.28	695	460	UPM1J101MHD6
	120	10×20	0.08	226.8	0.10	0.20	820	555	UPM1J121MPD
	120	12.5×15	0.08	226.8	0.12	0.24	750	510	UPM1J121MHD6
	150	10×25	0.08	283.5	0.090	0.18	950	665	UPM1J151MPD
	150	12.5×15	0.08	283.5	0.095	0.19	845	590	UPM1J151MHD6
	180	10×30.5	0.08	340.2	0.075	0.15	1110	790	UPM1J181MPD
	180	16×15	0.08	340.2	0.080	0.16	1050	750	UPM1J181MHD6
	220	12.5×20	0.08	415.8	0.065	0.13	1140	835	UPM1J221MHD
	220	16×15	0.08	415.8	0.070	0.14	1120	820	UPM1J221MHD6
	270	12.5×25	0.08	510.3	0.055	0.11	1340	1000	UPM1J271MHD
	270	18×15	0.08	510.3	0.060	0.12	1290	965	UPM1J271MHD6
	330	12.5×25	0.08	623.7	0.049	0.098	1420	1090	UPM1J331MHD
	330	18×15	0.08	623.7	0.050	0.10	1410	1080	UPM1J331MHD6
	390	12.5×30.5	0.08	737.1	0.043	0.086	1620	1260	UPM1J391MHD
	390	16×20	0.08	737.1	0.047	0.094	1500	1170	UPM1J391MHD6
	470	12.5×35.5	0.08	888.3	0.039	0.078	1780	1420	UPM1J471MHD
	470	16×25	0.08	888.3	0.042	0.084	1700	1360	UPM1J471MHD6
	560	12.5×40	0.08	1058.4	0.035	0.070	1950	1590	UPM1J561MHD
560	18×20	0.08	1058.4	0.039	0.078	1730	1410	UPM1J561MHD6	
680	16×30.5	0.08	1285.2	0.032	0.064	2050	1700	UPM1J681MHD	

For cut leads, formed leads or taped parts, please add the appropriate code after the size code (12th digit).
If there is no size code in the part number, please add size code "1" and then add the appropriate code.

UPM

■ Dimensions

Rated Voltage (V) (code)	Rated Capacitance (μF)	Case Size φD×L (mm)	tan δ	Leakage Current (μA) (at 20°C after 1 minute)	Impedance (Ω) max.		Rated Ripple (mArms)		Part Number
					20°C/100kHz	-10°C/100kHz	105°C/10 to 200kHz	105°C/120Hz	
63 (1J)	680	18×25	0.08	1285.2	0.035	0.070	1940	1610	UPM1J681MHD6
	820	16×35.5	0.08	1549.8	0.029	0.058	2220	1890	UPM1J821MHD
	820	18×30.5	0.08	1549.8	0.032	0.064	2110	1790	UPM1J821MHD6
	1000	16×40	0.08	1890	0.027	0.054	2370	2050	UPM1J102MHD
	1000	18×35.5	0.08	1890	0.029	0.058	2280	1970	UPM1J102MHD6
	1200	18×40	0.08	2268	0.025	0.050	2510	2210	UPM1J122MHD
80 (1K)	33	8×11.5	0.08	79.2	0.53	1.40	275	150	UPM1K330MPD
	39	8×15	0.08	93.6	0.46	1.20	300	170	UPM1K390MPD
	39	10×12.5	0.08	93.6	0.49	1.30	380	215	UPM1K390MPD6
	47	8×15	0.08	112.8	0.39	1.10	360	215	UPM1K470MPD
	47	10×12.5	0.08	112.8	0.42	1.10	410	245	UPM1K470MPD6
	56	8×20	0.08	134.4	0.34	0.92	490	295	UPM1K560MPD
	56	10×16	0.08	134.4	0.36	0.97	500	305	UPM1K560MPD6
	68	10×20	0.08	163.2	0.28	0.76	570	355	UPM1K680MPD
	68	12.5×15	0.08	163.2	0.31	0.84	520	325	UPM1K680MHD6
	82	10×20	0.08	196.8	0.25	0.68	620	395	UPM1K820MPD
	82	12.5×15	0.08	196.8	0.27	0.73	560	355	UPM1K820MHD6
	100	10×25	0.08	240	0.21	0.57	795	525	UPM1K101MPD
	100	12.5×15	0.08	240	0.23	0.62	605	400	UPM1K101MHD6
	120	10×30.5	0.08	288	0.18	0.49	870	585	UPM1K121MPD
	120	16×15	0.08	288	0.20	0.54	663	445	UPM1K121MHD6
	150	10×30.5	0.08	360	0.15	0.41	955	665	UPM1K151MPD
	150	16×15	0.08	360	0.18	0.47	699	470	UPM1K151MHD6
	180	12.5×25	0.08	432	0.13	0.35	1040	735	UPM1K181MHD
	180	16×15	0.08	432	0.15	0.41	766	545	UPM1K181MHD6
	220	12.5×30.5	0.08	528	0.12	0.32	1160	845	UPM1K221MHD
	220	18×15	0.08	528	0.13	0.35	881	645	UPM1K221MHD6
	270	12.5×30.5	0.08	648	0.10	0.27	1270	945	UPM1K271MHD
	270	16×20	0.08	648	0.11	0.30	1240	920	UPM1K271MHD6
	330	12.5×35.5	0.08	792	0.088	0.24	1450	1100	UPM1K331MHD
	330	16×25	0.08	792	0.099	0.27	1440	1100	UPM1K331MHD6
	390	12.5×40	0.08	936	0.078	0.21	1610	1250	UPM1K391MHD
	390	18×20	0.08	936	0.089	0.24	1450	1120	UPM1K391MHD6
	470	16×30.5	0.08	1128	0.069	0.19	1790	1430	UPM1K471MHD
	470	18×25	0.08	1128	0.080	0.22	1650	1320	UPM1K471MHD6
	560	16×35.5	0.08	1344	0.062	0.17	2000	1640	UPM1K561MHD
	560	18×30.5	0.08	1344	0.072	0.19	1750	1430	UPM1K561MHD6
	680	16×40	0.08	1632	0.055	0.15	2200	1830	UPM1K681MHD
680	18×30.5	0.08	1632	0.065	0.18	1850	1540	UPM1K681MHD6	
820	18×35.5	0.08	1968	0.049	0.13	2250	1910	UPM1K821MHD	
1000	18×40	0.08	2400	0.044	0.12	2370	2050	UPM1K102MHD	

For cut leads, formed leads or taped parts, please add the appropriate code after the size code (12th digit).
 If there is no size code in the part number, please add size code "1" and then add the appropriate code.

UPM

■ Dimensions

Rated Voltage (V) (code)	Rated Capacitance (μF)	Case Size φD×L (mm)	tan δ	Leakage Current (μA) (at 20°C after 1 minute)	Impedance (Ω) max.		Rated Ripple (mA _{rms})		Part Number
					20°C/ 100kHz	-10°C/ 100kHz	105°C/ 10 to 200kHz	105°C/ 120Hz	
100 (2A)	22	8×11.5	0.08	66	0.55	1.50	275	145	UPM2A220MPD
	27	8×15	0.08	81	0.47	1.30	300	160	UPM2A270MPD
	27	10×12.5	0.08	81	0.50	1.40	380	205	UPM2A270MPD6
	33	8×15	0.08	99	0.38	1.00	360	200	UPM2A330MPD
	33	10×12.5	0.08	99	0.42	1.10	410	230	UPM2A330MPD6
	39	8×20	0.08	117	0.33	0.89	490	280	UPM2A390MPD
	39	10×16	0.08	117	0.36	0.97	500	285	UPM2A390MPD6
	47	10×20	0.08	141	0.28	0.76	570	340	UPM2A470MPD
	47	12.5×15	0.08	141	0.31	0.84	520	310	UPM2A470MHD6
	56	10×20	0.08	168	0.24	0.65	620	375	UPM2A560MPD
	56	12.5×15	0.08	168	0.27	0.73	560	340	UPM2A560MHD6
	68	10×25	0.08	204	0.21	0.57	795	500	UPM2A680MPD
	68	12.5×15	0.08	204	0.23	0.62	605	380	UPM2A680MHD6
	82	10×30.5	0.08	246	0.18	0.49	870	555	UPM2A820MPD
	82	16×15	0.08	246	0.19	0.51	681	435	UPM2A820MHD6
	100	10×30.5	0.08	300	0.15	0.41	955	635	UPM2A101MPD
	100	16×15	0.08	300	0.17	0.46	719	475	UPM2A101MHD6
	120	12.5×25	0.08	360	0.13	0.35	1040	700	UPM2A121MHD
	120	16×15	0.08	360	0.14	0.38	793	535	UPM2A121MHD6
	150	12.5×25	0.08	450	0.11	0.30	1120	780	UPM2A151MHD
	150	18×15	0.08	450	0.12	0.32	917	640	UPM2A151MHD6
	180	12.5×30.5	0.08	540	0.098	0.26	1270	900	UPM2A181MHD
	180	16×20	0.08	540	0.11	0.30	1240	880	UPM2A181MHD6
	220	12.5×35.5	0.08	660	0.087	0.23	1450	1050	UPM2A221MHD
	220	16×25	0.08	660	0.093	0.25	1440	1050	UPM2A221MHD6
	270	12.5×40	0.08	810	0.072	0.19	1610	1200	UPM2A271MHD
	270	18×20	0.08	810	0.080	0.22	1450	1080	UPM2A271MHD6
	330	16×30.5	0.08	990	0.062	0.17	1790	1370	UPM2A331MHD
	330	18×25	0.08	990	0.070	0.19	1650	1260	UPM2A331MHD6
	390	16×35.5	0.08	1170	0.053	0.14	2000	1550	UPM2A391MHD
390	18×30.5	0.08	1170	0.062	0.17	1850	1430	UPM2A391MHD6	
470	16×40	0.08	1410	0.047	0.13	2200	1760	UPM2A471MHD	
470	18×35.5	0.08	1410	0.056	0.15	1970	1570	UPM2A471MHD6	
560	18×35.5	0.08	1680	0.041	0.11	2250	1840	UPM2A561MHD	
680	18×40	0.08	2040	0.036	0.097	2300	1910	UPM2A681MHD	

For cut leads, formed leads or taped parts, please add the appropriate code after the size code (12th digit).
If there is no size code in the part number, please add size code "1" and then add the appropriate code.

• For formed lead or taped product specifications and minimum order quantity, please refer to the Guidelines for Aluminum Electrolytic Capacitors.

ALUMINUM ELECTROLYTIC CAPACITORS

UPW Miniature Sized, Low Impedance,
High Reliability For
Switching Power Supplies



- Smaller case size and lower impedance than UPM.
- Low impedance and high reliability withstanding 3000 hours to 8000 hours.
- Capacitance ranges available based on the numerical values in E12 series under JIS.
- Compliant to the RoHS directive (2011/65/EU,(EU)2015/863).
- AEC-Q200 Qualified. Please contact us for details.

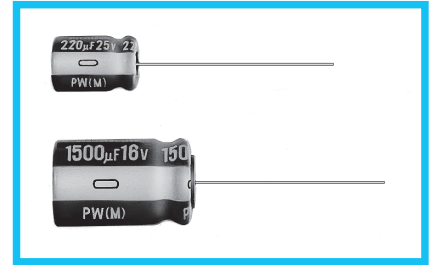
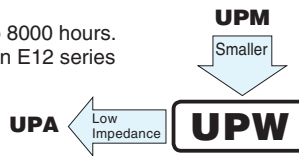

Specifications

Item	Performance Characteristics																		
Category Temperature Range	-55 to +105°C (6.3 to 100V)																		
Rated Voltage Range	6.3 to 100V																		
Rated Capacitance Range	15 to 15000µF																		
Capacitance Tolerance	±20% at 120Hz, 20°C																		
Leakage Current ※	After 1 minute's application of rated voltage at 20°C, leakage current is not more than 0.03CV(µA).																		
Tangent of loss angle (tan δ)	For capacitance of more than 1000µF, add 0.02 for every increase of 1000µF. Measurement frequency : 120Hz at 20°C <table border="1"> <tr> <td>Rated voltage (V)</td> <td>6.3</td> <td>10</td> <td>16</td> <td>25</td> <td>35</td> <td>50</td> <td>63</td> <td>100</td> </tr> <tr> <td>tan δ (max.)</td> <td>0.22</td> <td>0.19</td> <td>0.16</td> <td>0.14</td> <td>0.12</td> <td>0.10</td> <td>0.09</td> <td>0.08</td> </tr> </table>	Rated voltage (V)	6.3	10	16	25	35	50	63	100	tan δ (max.)	0.22	0.19	0.16	0.14	0.12	0.10	0.09	0.08
Rated voltage (V)	6.3	10	16	25	35	50	63	100											
tan δ (max.)	0.22	0.19	0.16	0.14	0.12	0.10	0.09	0.08											
Stability at Low Temperature	<table border="1"> <tr> <td colspan="2">Rated voltage (V)</td> <td>6.3 · 10</td> <td>16 · 25</td> <td>35 · 50</td> <td>63 · 100</td> </tr> <tr> <td>Impedance ratio (max.)</td> <td>Z(-55°C) / Z(+20°C)</td> <td>3</td> <td>3</td> <td>3</td> <td>3</td> </tr> </table>	Rated voltage (V)		6.3 · 10	16 · 25	35 · 50	63 · 100	Impedance ratio (max.)	Z(-55°C) / Z(+20°C)	3	3	3	3						
Rated voltage (V)		6.3 · 10	16 · 25	35 · 50	63 · 100														
Impedance ratio (max.)	Z(-55°C) / Z(+20°C)	3	3	3	3														
Endurance	<p>The specifications listed below shall be met when the capacitors are restored to 20°C after D.C. bias plus rated ripple current is applied at 105°C for the condition listed at right. The peak voltage shall not exceed the rated voltage.</p> <table border="1"> <tr> <td>Rated Voltage</td> <td>φD(mm)</td> <td>φ8</td> <td>φ10</td> <td>φ12.5</td> <td>≥φ16</td> </tr> <tr> <td>6.3~100V</td> <td></td> <td>3000hrs.</td> <td>5000hrs.</td> <td>7000hrs.</td> <td>8000hrs.</td> </tr> </table> <table border="1"> <tr> <td>Capacitance change</td> <td>Within ±20% of the initial capacitance value</td> </tr> <tr> <td>tan δ</td> <td>200% or less than the initial specified value</td> </tr> <tr> <td>Leakage current</td> <td>Less than or equal to the initial specified value</td> </tr> </table>	Rated Voltage	φD(mm)	φ8	φ10	φ12.5	≥φ16	6.3~100V		3000hrs.	5000hrs.	7000hrs.	8000hrs.	Capacitance change	Within ±20% of the initial capacitance value	tan δ	200% or less than the initial specified value	Leakage current	Less than or equal to the initial specified value
Rated Voltage	φD(mm)	φ8	φ10	φ12.5	≥φ16														
6.3~100V		3000hrs.	5000hrs.	7000hrs.	8000hrs.														
Capacitance change	Within ±20% of the initial capacitance value																		
tan δ	200% or less than the initial specified value																		
Leakage current	Less than or equal to the initial specified value																		
Shelf Life	After storing the capacitors under no load at 105°C for 1000 hours and then performing voltage treatment based on JIS C 5101-4 clause 4.1 at 20°C, they shall meet the specified values for the endurance characteristics listed above.																		
Marking	Printed with white color letter on dark brown sleeve.																		

※ I : Leakage Current (µA), C : Rated Capacitance (µF), V : Rated Voltage (V)

Radial Lead Type

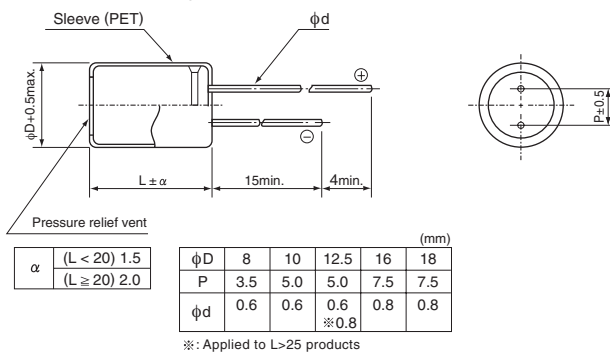

Type numbering system (Example : 10V 680µF)

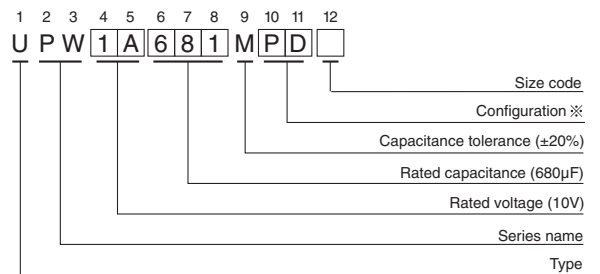

※ Configuration

φ D	Pb-free leadwire Pb-free PET sleeve
8 · 10	PD
12.5 to 18	HD

- Please refer to the Guidelines for Aluminum Electrolytic Capacitors for end seal configuration information.

Frequency coefficient of rated ripple current

Cap. (µF)	Frequency	50Hz	120Hz	300Hz	1kHz	10kHz or more
15 to 47		0.20	0.30	0.50	0.80	1.00
68 to 330		0.55	0.65	0.75	0.85	1.00
390 to 1000		0.70	0.75	0.80	0.90	1.00
1200 to 15000		0.80	0.85	0.90	0.95	1.00

• Dimension table in next page.

UPW

■ Dimensions

Rated Voltage (V) (code)	Rated Capacitance (μ F)	Case Size ϕ D \times L (mm)	tan δ	Leakage Current (μ A) (at 20°C after 1 minute)	Impedance (Ω) max.		Rated Ripple (mA _{rms}) (105°C/100kHz)	Part Number
					20°C/ 100kHz	-10°C/ 100kHz		
6.3 (0J)	470	8 \times 11.5	0.22	88.83	0.117	0.234	555	UPW0J471MPD
	560	8 \times 11.5	0.22	105.84	0.117	0.234	555	UPW0J561MPD
	680	10 \times 12.5	0.22	128.52	0.090	0.18	755	UPW0J681MPD
	820	8 \times 15	0.22	154.98	0.085	0.17	730	UPW0J821MPD
	820	10 \times 12.5	0.22	154.98	0.090	0.18	755	UPW0J821MPD6
	1000	10 \times 12.5	0.22	189	0.090	0.18	755	UPW0J102MPD
	1200	8 \times 20	0.22	226.8	0.065	0.13	995	UPW0J122MPD
	1200	10 \times 16	0.22	226.8	0.068	0.136	1050	UPW0J122MPD6
	1500	10 \times 20	0.22	283.5	0.052	0.104	1220	UPW0J152MPD
	2200	12.5 \times 20	0.24	415.8	0.038	0.076	1655	UPW0J222MHD
	2200	10 \times 25	0.24	415.8	0.045	0.090	1440	UPW0J222MPD6
	2700	10 \times 30.5	0.24	510.3	0.035	0.070	1815	UPW0J272MPD
	3300	12.5 \times 20	0.26	623.7	0.038	0.076	1655	UPW0J332MHD
	3900	12.5 \times 25	0.26	737.1	0.030	0.060	1945	UPW0J392MHD
	4700	16 \times 25	0.28	888.3	0.022	0.044	2555	UPW0J472MHD
	4700	12.5 \times 30.5	0.28	888.3	0.025	0.050	2310	UPW0J472MHD6
	5600	12.5 \times 35.5	0.30	1058.4	0.022	0.044	2510	UPW0J562MHD
	5600	16 \times 20	0.30	1058.4	0.029	0.058	2210	UPW0J562MHD6
	6800	16 \times 25	0.32	1285.2	0.022	0.044	2560	UPW0J682MHD
	6800	18 \times 20	0.32	1285.2	0.028	0.056	2490	UPW0J682MHD6
8200	16 \times 30.5	0.36	1549.8	0.018	0.036	3010	UPW0J822MHD	
10000	16 \times 30.5	0.40	1890	0.016	0.032	3150	UPW0J103MHD	
10000	18 \times 25	0.40	1890	0.020	0.040	2740	UPW0J103MHD6	
12000	18 \times 30.5	0.44	2268	0.016	0.032	3635	UPW0J123MHD	
15000	18 \times 35.5	0.50	2835	0.015	0.030	3680	UPW0J153MHD	
10 (1A)	330	8 \times 11.5	0.19	99	0.117	0.234	555	UPW1A331MPD
	470	8 \times 11.5	0.19	141	0.117	0.234	555	UPW1A471MPD
	680	10 \times 12.5	0.19	204	0.090	0.18	760	UPW1A681MPD
	680	8 \times 15	0.19	204	0.085	0.17	730	UPW1A681MPD6
	1000	10 \times 16	0.19	300	0.068	0.136	1050	UPW1A102MPD
	1000	8 \times 20	0.19	300	0.065	0.13	995	UPW1A102MPD6
	1200	10 \times 20	0.19	360	0.052	0.104	1220	UPW1A122MPD
	1500	10 \times 20	0.19	450	0.052	0.104	1220	UPW1A152MPD
	1500	10 \times 25	0.19	450	0.045	0.090	1440	UPW1A152MPD6
	2200	12.5 \times 20	0.21	660	0.038	0.076	1655	UPW1A222MHD
	2200	10 \times 30.5	0.21	660	0.035	0.070	1815	UPW1A222MPD6
	2700	12.5 \times 25	0.21	810	0.030	0.060	1945	UPW1A272MHD
	3300	12.5 \times 25	0.23	990	0.030	0.060	1950	UPW1A332MHD
	3300	12.5 \times 30.5	0.23	990	0.025	0.050	2310	UPW1A332MHD6
	3900	12.5 \times 35.5	0.23	1170	0.022	0.044	2510	UPW1A392MHD
	3900	16 \times 20	0.23	1170	0.029	0.058	2210	UPW1A392MHD6
	4700	16 \times 25	0.25	1410	0.022	0.044	2555	UPW1A472MHD
	5600	16 \times 25	0.27	1680	0.022	0.044	2560	UPW1A562MHD
	5600	18 \times 20	0.27	1680	0.028	0.056	2490	UPW1A562MHD6
	6800	16 \times 30.5	0.29	2040	0.018	0.036	3010	UPW1A682MHD
	6800	18 \times 25	0.29	2040	0.020	0.040	2740	UPW1A682MHD6
	8200	16 \times 35.5	0.33	2460	0.016	0.032	3150	UPW1A822MHD
	8200	18 \times 30.5	0.33	2460	0.016	0.032	3635	UPW1A822MHD6
	10000	18 \times 35.5	0.37	3000	0.015	0.030	3680	UPW1A103MHD
	15000	18 \times 40	0.47	4500	0.014	0.028	3800	UPW1A153MHD

For cut leads, formed leads or taped parts, please add the appropriate code after the size code (12th digit).
If there is no size code in the part number, please add size code "1" and then add the appropriate code.

UPW

■ Dimensions

Rated Voltage (V) (code)	Rated Capacitance (μ F)	Case Size ϕ D×L (mm)	tan δ	Leakage Current (μ A) (at 20°C after 1 minute)	Impedance (Ω) max.		Rated Ripple (mA _{rms}) (105°C/100kHz)	Part Number
					20°C/ 100kHz	-10°C/ 100kHz		
16 (1C)	220	8×11.5	0.16	105.6	0.117	0.234	555	UPW1C221MPD
	330	8×11.5	0.16	158.4	0.117	0.234	555	UPW1C331MPD
	470	10×12.5	0.16	225.6	0.090	0.18	760	UPW1C471MPD
	470	8×15	0.16	225.6	0.085	0.17	730	UPW1C471MPD6
	680	10×16	0.16	326.4	0.068	0.136	1050	UPW1C681MPD
	680	8×20	0.16	326.4	0.065	0.13	995	UPW1C681MPD6
	820	10×20	0.16	393.6	0.052	0.104	1220	UPW1C821MPD
	1000	10×20	0.16	480	0.052	0.104	1220	UPW1C102MPD
	1200	10×25	0.16	576	0.045	0.090	1440	UPW1C122MPD
	1500	12.5×20	0.16	720	0.038	0.076	1655	UPW1C152MHD
	1500	10×30.5	0.16	720	0.035	0.070	1815	UPW1C152MPD6
	2200	12.5×25	0.18	1056	0.030	0.060	1945	UPW1C222MHD
	2700	12.5×30.5	0.18	1296	0.025	0.050	2310	UPW1C272MHD
	2700	16×20	0.18	1296	0.029	0.058	2210	UPW1C272MHD6
	3300	16×25	0.20	1584	0.022	0.044	2555	UPW1C332MHD
	3300	12.5×35.5	0.20	1584	0.022	0.044	2510	UPW1C332MHD6
	3900	16×25	0.20	1872	0.022	0.044	2560	UPW1C392MHD
	3900	18×20	0.20	1872	0.028	0.056	2490	UPW1C392MHD6
	4700	16×30.5	0.22	2256	0.018	0.036	3010	UPW1C472MHD
	4700	18×25	0.22	2256	0.020	0.040	2740	UPW1C472MHD6
5600	16×35.5	0.24	2688	0.016	0.032	3150	UPW1C562MHD	
5600	18×30.5	0.24	2688	0.016	0.032	3635	UPW1C562MHD6	
6800	18×35.5	0.26	3264	0.015	0.030	3680	UPW1C682MHD	
8200	18×35.5	0.30	3936	0.015	0.030	3680	UPW1C822MHD	
10000	18×40	0.34	4800	0.014	0.028	3800	UPW1C103MHD	
25 (1E)	150	8×11.5	0.14	112.5	0.117	0.234	555	UPW1E151MPD
	220	8×11.5	0.14	165	0.117	0.234	555	UPW1E221MPD
	330	10×12.5	0.14	247.5	0.090	0.18	760	UPW1E331MPD
	330	8×15	0.14	247.5	0.085	0.17	730	UPW1E331MPD6
	470	10×16	0.14	352.5	0.068	0.136	1050	UPW1E471MPD
	470	8×20	0.14	352.5	0.065	0.13	995	UPW1E471MPD6
	560	10×20	0.14	420	0.052	0.104	1220	UPW1E561MPD
	680	10×20	0.14	510	0.052	0.104	1220	UPW1E681MPD
	820	10×25	0.14	615	0.045	0.090	1440	UPW1E821MPD
	1000	12.5×20	0.14	750	0.038	0.076	1660	UPW1E102MHD
	1000	10×30.5	0.14	750	0.035	0.070	1815	UPW1E102MPD6
	1500	16×25	0.14	1125	0.022	0.044	2555	UPW1E152MHD
	1500	12.5×25	0.14	1125	0.030	0.060	1950	UPW1E152MHD6
	1800	12.5×30.5	0.14	1350	0.025	0.050	2310	UPW1E182MHD
	1800	16×20	0.14	1350	0.029	0.058	2210	UPW1E182MHD6
	2200	16×25	0.16	1650	0.022	0.044	2555	UPW1E222MHD
	2200	18×20	0.16	1650	0.028	0.056	2490	UPW1E222MHD6
	2200	12.5×35.5	0.16	1650	0.022	0.044	2510	UPW1E222MHD3
	2700	16×25	0.16	2025	0.022	0.044	2555	UPW1E272MHD
	3300	16×30.5	0.18	2475	0.018	0.036	3010	UPW1E332MHD
	3300	18×25	0.18	2475	0.020	0.040	2740	UPW1E332MHD6
	3900	16×35.5	0.18	2925	0.016	0.032	3150	UPW1E392MHD
	3900	18×30.5	0.18	2925	0.016	0.032	3635	UPW1E392MHD6
	4700	18×35.5	0.20	3525	0.015	0.030	3680	UPW1E472MHD
6800	18×40	0.24	5100	0.014	0.028	3800	UPW1E682MHD	

For cut leads, formed leads or taped parts, please add the appropriate code after the size code (12th digit).
If there is no size code in the part number, please add size code "1" and then add the appropriate code.

UPW

■ Dimensions

Rated Voltage (V) (code)	Rated Capacitance (μ F)	Case Size ϕ D×L (mm)	tan δ	Leakage Current (μ A) (at 20°C after 1 minute)	Impedance (Ω) max.		Rated Ripple (mArms) (105°C/100kHz)	Part Number
					20°C/ 100kHz	-10°C/ 100kHz		
35 (1V)	100	8×11.5	0.12	105	0.117	0.234	555	UPW1V101MPD
	150	8×11.5	0.12	157.5	0.117	0.234	555	UPW1V151MPD
	220	10×12.5	0.12	231	0.090	0.18	760	UPW1V221MPD
	220	8×15	0.12	231	0.085	0.17	730	UPW1V221MPD6
	330	10×16	0.12	346.5	0.068	0.136	1050	UPW1V331MPD
	330	8×20	0.12	346.5	0.065	0.13	995	UPW1V331MPD6
	390	10×20	0.12	409.5	0.052	0.104	1220	UPW1V391MPD
	470	10×20	0.12	493.5	0.052	0.104	1220	UPW1V471MPD
	560	10×25	0.12	588	0.045	0.090	1440	UPW1V561MPD
	680	12.5×20	0.12	714	0.038	0.076	1660	UPW1V681MHD
	680	10×30.5	0.12	714	0.035	0.070	1815	UPW1V681MPD6
	1000	12.5×25	0.12	1050	0.030	0.060	1950	UPW1V102MHD
	1200	12.5×30.5	0.12	1260	0.025	0.050	2310	UPW1V122MHD
	1200	16×20	0.12	1260	0.029	0.058	2210	UPW1V122MHD6
	1500	16×25	0.12	1575	0.022	0.044	2555	UPW1V152MHD
	1500	12.5×35.5	0.12	1575	0.022	0.044	2510	UPW1V152MHD6
	1800	16×25	0.12	1890	0.022	0.044	2555	UPW1V182MHD
	1800	18×20	0.12	1890	0.028	0.056	2490	UPW1V182MHD6
	2200	16×30.5	0.14	2310	0.018	0.036	3010	UPW1V222MHD
	2200	18×25	0.14	2310	0.020	0.040	2740	UPW1V222MHD6
2700	16×35.5	0.14	2835	0.016	0.032	3150	UPW1V272MHD	
2700	18×30.5	0.14	2835	0.016	0.032	3635	UPW1V272MHD6	
3300	18×35.5	0.16	3465	0.015	0.030	3680	UPW1V332MHD	
4700	18×40	0.18	4935	0.014	0.028	3800	UPW1V472MHD	
50 (1H)	82	8×11.5	0.10	123	0.234	0.468	485	UPW1H820MPD
	100	8×11.5	0.10	150	0.234	0.468	485	UPW1H101MPD
	120	8×15	0.10	180	0.155	0.31	635	UPW1H121MPD
	120	10×12.5	0.10	180	0.162	0.324	620	UPW1H121MPD6
	150	10×12.5	0.10	225	0.162	0.324	615	UPW1H151MPD
	180	8×20	0.10	270	0.12	0.24	860	UPW1H181MPD
	180	10×16	0.10	270	0.119	0.238	850	UPW1H181MPD6
	220	10×16	0.10	330	0.119	0.238	850	UPW1H221MPD
	220	10×20	0.10	330	0.090	0.18	1030	UPW1H221MPD6
	270	10×25	0.10	405	0.082	0.164	1200	UPW1H271MPD
	330	10×20	0.10	495	0.090	0.18	1030	UPW1H331MPD
	330	10×30.5	0.10	495	0.060	0.12	1610	UPW1H331MPD6
	390	12.5×20	0.10	585	0.063	0.126	1480	UPW1H391MHD
	470	12.5×20	0.10	705	0.060	0.12	1500	UPW1H471MHD
	560	12.5×25	0.10	840	0.050	0.10	1832	UPW1H561MHD
	680	12.5×25	0.10	1020	0.050	0.10	1840	UPW1H681MHD
	680	16×20	0.10	1020	0.048	0.096	1840	UPW1H681MHD6
	820	12.5×35.5	0.10	1230	0.034	0.068	2290	UPW1H821MHD
	820	18×20	0.10	1230	0.042	0.084	2420	UPW1H821MHD6
	1000	16×25	0.10	1500	0.034	0.068	2235	UPW1H102MHD
1200	16×30.5	0.10	1800	0.028	0.056	2700	UPW1H122MHD	
1200	18×25	0.10	1800	0.029	0.058	2610	UPW1H122MHD6	
1500	16×30.5	0.10	2250	0.028	0.056	2700	UPW1H152MHD	
1500	16×35.5	0.10	2250	0.025	0.050	2790	UPW1H152MHD6	
1800	18×30.5	0.10	2700	0.025	0.050	3000	UPW1H182MHD	
2200	18×35.5	0.12	3300	0.023	0.046	3100	UPW1H222MHD	

For cut leads, formed leads or taped parts, please add the appropriate code after the size code (12th digit).
If there is no size code in the part number, please add size code "1" and then add the appropriate code.

UPW

■ Dimensions

Rated Voltage (V) (code)	Rated Capacitance (μ F)	Case Size ϕ D×L (mm)	tan δ	Leakage Current (μ A) (at 20°C after 1 minute)	Impedance (Ω) max.		Rated Ripple (mArms) (105°C/100kHz)	Part Number
					20°C/ 100kHz	-10°C/ 100kHz		
63 (1J)	47	8×11.5	0.09	88.83	0.342	0.684	405	UPW1J470MPD
	68	8×11.5	0.09	128.52	0.342	0.684	405	UPW1J680MPD
	100	10×12.5	0.09	189	0.256	0.512	540	UPW1J101MPD
	100	8×15	0.09	189	0.23	0.46	535	UPW1J101MPD6
	120	10×16	0.09	226.8	0.194	0.388	600	UPW1J121MPD
	150	10×16	0.09	283.5	0.194	0.388	660	UPW1J151MPD
	180	10×20	0.09	340.2	0.147	0.294	890	UPW1J181MPD
	180	12.5×15	0.09	340.2	0.15	0.30	1020	UPW1J181MHD6
	220	10×20	0.09	415.8	0.147	0.294	885	UPW1J221MPD
	220	10×25	0.09	415.8	0.13	0.26	1050	UPW1J221MPD6
	270	16×15	0.09	510.3	0.090	0.18	1410	UPW1J271MHD
	330	12.5×20	0.09	623.7	0.085	0.17	1290	UPW1J331MHD
	390	12.5×25	0.09	737.1	0.070	0.14	1720	UPW1J391MHD
	390	18×15	0.09	737.1	0.086	0.172	1690	UPW1J391MHD6
	470	12.5×25	0.09	888.3	0.070	0.14	1720	UPW1J471MHD
	470	12.5×30.5	0.09	888.3	0.055	0.11	2090	UPW1J471MHD6
	470	16×20	0.09	888.3	0.059	0.118	1770	UPW1J471MHD3
	680	16×25	0.09	1285.2	0.050	0.10	2160	UPW1J681MHD
	680	12.5×35.5	0.09	1285.2	0.047	0.094	2270	UPW1J681MHD6
	680	18×20	0.09	1285.2	0.055	0.11	2290	UPW1J681MHD3
	820	16×30.5	0.09	1549.8	0.043	0.086	2670	UPW1J821MHD
	820	18×25	0.09	1549.8	0.043	0.086	2590	UPW1J821MHD6
1000	16×30.5	0.09	1890	0.043	0.086	2770	UPW1J102MHD	
1000	16×35.5	0.09	1890	0.036	0.072	2770	UPW1J102MHD6	
1200	18×30.5	0.09	2268	0.032	0.064	2950	UPW1J122MHD	
1500	18×35.5	0.09	2835	0.030	0.060	3100	UPW1J152MHD	
2200	18×40	0.11	4158	0.028	0.056	3200	UPW1J222MHD	
100 (2A)	15	8×11.5	0.08	45	0.83	1.66	180	UPW2A150MPD
	22	8×11.5	0.08	66	0.68	1.36	230	UPW2A220MPD
	33	10×12.5	0.08	99	0.46	0.92	320	UPW2A330MPD
	33	8×15	0.08	99	0.45	0.90	360	UPW2A330MPD6
	47	10×16	0.08	141	0.37	0.74	420	UPW2A470MPD
	47	8×20	0.08	141	0.37	0.74	420	UPW2A470MPD6
	68	10×20	0.08	204	0.30	0.60	490	UPW2A680MPD
	82	10×25	0.08	246	0.25	0.50	540	UPW2A820MPD
	100	12.5×20	0.08	300	0.18	0.36	580	UPW2A101MHD
	150	12.5×25	0.08	450	0.13	0.26	710	UPW2A151MHD
	180	12.5×30.5	0.08	540	0.12	0.24	790	UPW2A181MHD
	180	16×20	0.08	540	0.13	0.26	750	UPW2A181MHD6
	220	16×25	0.08	660	0.10	0.20	890	UPW2A221MHD
	220	18×20	0.08	660	0.11	0.22	850	UPW2A221MHD6
	330	16×25	0.08	990	0.090	0.18	1080	UPW2A331MHD
	390	18×25	0.08	1170	0.083	0.166	1260	UPW2A391MHD
	470	16×30.5	0.08	1410	0.076	0.152	1310	UPW2A471MHD
	560	18×30.5	0.08	1680	0.068	0.136	1370	UPW2A561MHD
	680	16×35.5	0.08	2040	0.064	0.128	1410	UPW2A681MHD
	1000	18×40	0.08	3000	0.047	0.094	1520	UPW2A102MHD

For cut leads, formed leads or taped parts, please add the appropriate code after the size code (12th digit).

If there is no size code in the part number, please add size code "1" and then add the appropriate code.

- For formed lead or taped product specifications and minimum order quantity, please refer to the Guidelines for Aluminum Electrolytic Capacitors.

ALUMINUM ELECTROLYTIC CAPACITORS

UPA Miniature Sized, Low Impedance,
High Reliability For
Switching Power Supplies



- Lower impedance than UPW.
- Smaller case size and high ripple current.
- Compliant to the RoHS directive (2011/65/EU,(EU)2015/863).



Specifications

Item	Performance Characteristics							
Category Temperature Range	-55 to +105°C							
Rated Voltage Range	6.3 to 35V							
Rated Capacitance Range	180 to 10000µF							
Capacitance Tolerance	±20% at 120Hz, 20°C							
Leakage Current ※	After 1 minute's application of rated voltage at 20°C, leakage current is not more than 0.03CV or 4 (µA), whichever is greater.							
Tangent of loss angle (tan δ)	Rated voltage (V)	6.3	10	16	25	35	120Hz 20°C	
	tan δ (max.)	0.22	0.19	0.16	0.14	0.12		
For capacitance of more than 1000µF, add 0.02 for every increase of 1000µF.								
Stability at Low Temperature	Rated voltage (V)	6.3	10	16	25	35	120Hz	
	Impedance ratio (max.)	Z(-55°C) / Z(+20°C)	3	3	3	3		3
Endurance	The specifications listed below shall be met when the capacitors are restored to 20°C after D.C. bias plus rated ripple current is applied at 105°C for the condition listed at right. The peak voltage shall not exceed the rated voltage.			φD(mm)		φ8	φ10	≥φ12.5
	Rated Voltage			6.3~35V		3000hrs.	4000hrs.	5000hrs.
	Capacitance change	Within ±20% of the initial capacitance value (6.3V, 10V : ±30%)						
tan δ	200% or less than the initial specified value (6.3V, 10V : 300%)							
Leakage current	Less than or equal to the initial specified value							
Shelf Life	After storing the capacitors under no load at 105°C for 1000 hours and then performing voltage treatment based on JIS C 5101-4 clause 4.1 at 20°C, they shall meet the specified values for the endurance characteristics listed above.							
Marking	Printed with white color letter on dark brown sleeve.							

※ I : Leakage Current (µA), C : Rated Capacitance (µF), V : Rated Voltage (V)

Radial Lead Type

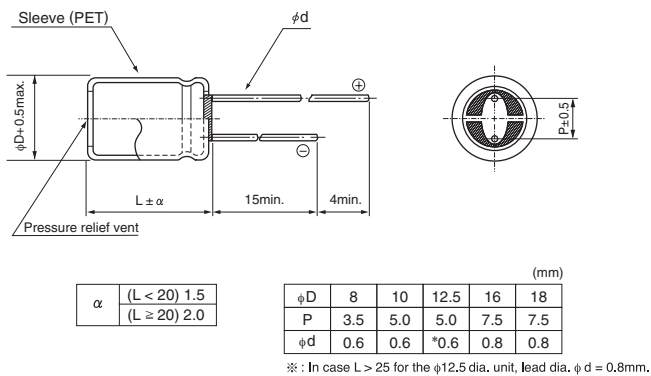

Type numbering system (Example : 10V 470µF)

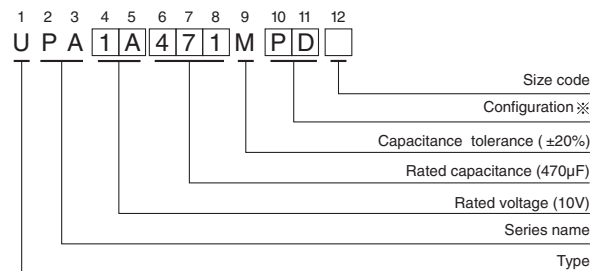

※ Configuration

φD	Pb-free leadwire Pb-free PET sleeve
8-10	PD
12.5 to 18	HD

- Please refer to the Guidelines for Aluminum Electrolytic Capacitors for end seal configuration information.

Frequency coefficient of rated ripple current

Cap. (µF)	Frequency	50Hz	120Hz	300Hz	1kHz	10kHz or more
180 to 330		0.55	0.65	0.75	0.85	1.00
390 to 1000		0.70	0.75	0.80	0.90	1.00
1200 to 10000		0.80	0.85	0.90	0.95	1.00

• Dimension table in next page.

UPA

■ Dimensions

Rated Voltage (V) (code)	Rated Capacitance (μ F)	Case Size ϕ D×L (mm)	tan δ	Leakage Current (μ A) (at 20°C after 1 minute)	Impedance (Ω) max.		Rated Ripple (mArms) (105°C/100kHz)	Part Number
					20°C/ 100kHz	-10°C/ 100kHz		
6.3 (0J)	560	8×11.5	0.22	105.84	0.090	0.18	630	UPA0J561MPD
	680	8×11.5	0.22	128.52	0.090	0.18	630	UPA0J681MPD
	1000	8×15	0.22	189	0.062	0.124	860	UPA0J102MPD
	1000	10×12.5	0.22	189	0.063	0.126	900	UPA0J102MPD6
	1200	10×12.5	0.22	226.8	0.063	0.126	900	UPA0J122MPD
	1200	10×16	0.22	226.8	0.049	0.098	1240	UPA0J122MPD3
	1500	8×20	0.22	283.5	0.044	0.088	1220	UPA0J152MPD
	1500	10×16	0.22	283.5	0.049	0.098	1240	UPA0J152MPD6
	1500	10×20	0.22	283.5	0.035	0.070	1490	UPA0J152MPD3
	2200	10×20	0.24	415.8	0.035	0.070	1490	UPA0J222MPD
	2200	10×25	0.24	415.8	0.033	0.066	1680	UPA0J222MPD3
	2700	10×25	0.24	510.3	0.033	0.066	1680	UPA0J272MPD
	3300	12.5×20	0.26	623.7	0.029	0.058	1890	UPA0J332MHD
	3900	12.5×25	0.26	737.1	0.022	0.044	2280	UPA0J392MHD
	4700	12.5×25	0.28	888.3	0.022	0.044	2280	UPA0J472MHD
	5600	12.5×30.5	0.30	1058.4	0.018	0.036	2720	UPA0J562MHD
	5600	16×20	0.30	1058.4	0.026	0.052	2330	UPA0J562MHD6
	6800	12.5×35.5	0.32	1285.2	0.016	0.032	2940	UPA0J682MHD
	8200	16×25	0.36	1549.8	0.019	0.038	2760	UPA0J822MHD
	8200	18×20	0.36	1549.8	0.025	0.050	2640	UPA0J822MHD6
10000	16×30.5	0.40	1890	0.017	0.034	2810	UPA0J103MHD	
10000	18×25	0.40	1890	0.018	0.036	2850	UPA0J103MHD6	
10 (1A)	470	8×11.5	0.19	141	0.090	0.18	630	UPA1A471MPD
	560	8×11.5	0.19	168	0.090	0.18	630	UPA1A561MPD
	820	8×15	0.19	246	0.062	0.124	860	UPA1A821MPD
	820	10×12.5	0.19	246	0.063	0.126	900	UPA1A821MPD6
	1000	8×20	0.19	300	0.044	0.088	1220	UPA1A102MPD
	1000	10×12.5	0.19	300	0.063	0.126	900	UPA1A102MPD6
	1000	10×16	0.19	300	0.049	0.098	1240	UPA1A102MPD3
	1200	8×20	0.19	360	0.044	0.088	1220	UPA1A122MPD
	1200	10×16	0.19	360	0.049	0.098	1240	UPA1A122MPD6
	1500	10×20	0.19	450	0.035	0.070	1490	UPA1A152MPD
	1800	10×20	0.19	540	0.035	0.070	1490	UPA1A182MPD
	1800	10×25	0.19	540	0.033	0.066	1680	UPA1A182MPD6
	2200	10×25	0.21	660	0.033	0.066	1680	UPA1A222MPD
	2200	12.5×20	0.21	660	0.029	0.058	1890	UPA1A222MHD3
	2700	12.5×20	0.21	810	0.029	0.058	1890	UPA1A272MHD
	3300	12.5×25	0.23	990	0.022	0.044	2280	UPA1A332MHD
	3900	12.5×25	0.23	1170	0.022	0.044	2280	UPA1A392MHD
	4700	12.5×30.5	0.25	1410	0.018	0.036	2720	UPA1A472MHD
	4700	16×20	0.25	1410	0.026	0.052	2330	UPA1A472MHD6
	5600	12.5×35.5	0.27	1680	0.016	0.032	2940	UPA1A562MHD
6800	16×25	0.29	2040	0.019	0.038	2760	UPA1A682MHD	
8200	16×30.5	0.33	2460	0.017	0.034	2810	UPA1A822MHD	
8200	18×25	0.33	2460	0.018	0.036	2850	UPA1A822MHD6	

For cut leads, formed leads or taped parts, please add the appropriate code after the size code (12th digit).
If there is no size code in the part number, please add size code "1" and then add the appropriate code.

UPA

■ Dimensions

Rated Voltage (V) (code)	Rated Capacitance (μ F)	Case Size ϕ D×L (mm)	tan δ	Leakage Current (μ A) (at 20°C after 1 minute)	Impedance (Ω) max.		Rated Ripple (mA _{rms}) (105°C/100kHz)	Part Number
					20°C/ 100kHz	-10°C/ 100kHz		
16 (1C)	330	8×11.5	0.16	158.4	0.090	0.18	630	UPA1C331MPD
	390	8×11.5	0.16	187.2	0.090	0.18	630	UPA1C391MPD
	470	10×12.5	0.16	225.6	0.063	0.126	900	UPA1C471MPD
	680	8×15	0.16	326.4	0.062	0.124	860	UPA1C681MPD
	680	10×12.5	0.16	326.4	0.063	0.126	900	UPA1C681MPD6
	820	8×20	0.16	393.6	0.044	0.088	1220	UPA1C821MPD
	820	10×16	0.16	393.6	0.049	0.098	1240	UPA1C821MPD6
	1000	10×16	0.16	480	0.049	0.098	1240	UPA1C102MPD
	1000	10×20	0.16	480	0.035	0.070	1490	UPA1C102MPD3
	1200	10×20	0.16	576	0.035	0.070	1490	UPA1C122MPD
	1500	10×25	0.16	720	0.033	0.066	1680	UPA1C152MPD
	2200	12.5×20	0.18	1056	0.029	0.058	1890	UPA1C222MHD
	2200	12.5×25	0.18	1056	0.022	0.044	2280	UPA1C222MHD3
	2700	12.5×25	0.18	1296	0.022	0.044	2280	UPA1C272MHD
	3300	12.5×30.5	0.20	1584	0.018	0.036	2720	UPA1C332MHD
	3300	16×20	0.20	1584	0.026	0.052	2330	UPA1C332MHD6
	3900	12.5×35.5	0.20	1872	0.016	0.032	2940	UPA1C392MHD
	4700	16×25	0.22	2256	0.019	0.038	2760	UPA1C472MHD
	4700	18×20	0.22	2256	0.025	0.050	2640	UPA1C472MHD6
	5600	16×30.5	0.24	2688	0.017	0.035	2810	UPA1C562MHD
5600	18×25	0.24	2688	0.018	0.036	2850	UPA1C562MHD6	
6800	18×25	0.26	3264	0.018	0.036	2850	UPA1C682MHD	
25 (1E)	270	8×11.5	0.14	202.5	0.090	0.18	630	UPA1E271MPD
	330	8×11.5	0.14	247.5	0.090	0.18	630	UPA1E331MPD
	390	8×15	0.14	292.5	0.062	0.124	860	UPA1E391MPD
	470	8×15	0.14	352.5	0.062	0.124	860	UPA1E471MPD
	470	10×12.5	0.14	352.5	0.063	0.126	900	UPA1E471MPD6
	560	8×20	0.14	420	0.044	0.088	1220	UPA1E561MPD
	560	10×16	0.14	420	0.049	0.098	1240	UPA1E561MPD6
	680	10×16	0.14	510	0.049	0.098	1240	UPA1E681MPD
	820	10×20	0.14	615	0.035	0.070	1490	UPA1E821MPD
	1000	10×25	0.14	750	0.033	0.066	1680	UPA1E102MPD
	1000	12.5×20	0.14	750	0.029	0.058	1890	UPA1E102MHD3
	1200	12.5×20	0.14	900	0.029	0.058	1890	UPA1E122MHD
	1800	12.5×25	0.14	1350	0.022	0.044	2280	UPA1E182MHD
	2200	12.5×30.5	0.16	1650	0.018	0.036	2720	UPA1E222MHD
	2200	16×20	0.16	1650	0.026	0.052	2330	UPA1E222MHD6
	2700	12.5×35.5	0.16	2025	0.016	0.032	2940	UPA1E272MHD
	3300	16×25	0.18	2475	0.019	0.038	2760	UPA1E332MHD
	3300	18×20	0.18	2475	0.025	0.050	2640	UPA1E332MHD6
4700	18×25	0.20	3525	0.018	0.036	2850	UPA1E472MHD	

For cut leads, formed leads or taped parts, please add the appropriate code after the size code (12th digit).
If there is no size code in the part number, please add size code "1" and then add the appropriate code.

UPA

■ Dimensions

Rated Voltage (V) (code)	Rated Capacitance (μ F)	Case Size ϕ D \times L (mm)	tan δ	Leakage Current (μ A) (at 20°C after 1 minute)	Impedance (Ω) max.		Rated Ripple (mA _{rms}) (105°C/100kHz)	Part Number
					20°C/ 100kHz	-10°C/ 100kHz		
35 (1V)	180	8 \times 11.5	0.12	189	0.090	0.18	630	UPA1V181MPD
	270	8 \times 15	0.12	283.5	0.062	0.124	860	UPA1V271MPD
	270	10 \times 12.5	0.12	283.5	0.063	0.126	900	UPA1V271MPD6
	390	8 \times 20	0.12	409.5	0.044	0.088	1220	UPA1V391MPD
	390	10 \times 16	0.12	409.5	0.049	0.098	1240	UPA1V391MPD6
	560	10 \times 20	0.12	588	0.035	0.070	1490	UPA1V561MPD
	680	10 \times 25	0.12	714	0.033	0.066	1680	UPA1V681MPD
	820	12.5 \times 20	0.12	861	0.029	0.058	1890	UPA1V821MHD
	1000	12.5 \times 20	0.12	1050	0.029	0.058	1890	UPA1V102MHD
	1200	12.5 \times 25	0.12	1260	0.022	0.044	2280	UPA1V122MHD
	1500	12.5 \times 30.5	0.12	1575	0.018	0.036	2720	UPA1V152MHD
	1500	16 \times 20	0.12	1575	0.026	0.052	2330	UPA1V152MHD6
	1800	12.5 \times 35.5	0.12	1890	0.016	0.032	2940	UPA1V182MHD
	1800	16 \times 20	0.12	1890	0.026	0.052	2330	UPA1V182MHD6
	2200	16 \times 25	0.14	2310	0.019	0.038	2760	UPA1V222MHD
	2200	18 \times 20	0.14	2310	0.025	0.050	2640	UPA1V222MHD6
	2700	16 \times 30.5	0.14	2835	0.017	0.035	2810	UPA1V272MHD
	2700	18 \times 25	0.14	2835	0.018	0.036	2850	UPA1V272MHD6
3300	18 \times 30.5	0.16	3465	0.016	0.032	2910	UPA1V332MHD	

For cut leads, formed leads or taped parts, please add the appropriate code after the size code (12th digit).
If there is no size code in the part number, please add size code "1" and then add the appropriate code.

- For formed lead or taped product specifications and minimum order quantity, please refer to the Guidelines for Aluminum Electrolytic Capacitors.

UHV High Ripple Low Impedance



- Lower impedance at high frequency range.
- Smaller case size and high ripple current.
- Compliant to the RoHS directive (2011/65/EU,(EU)2015/863).

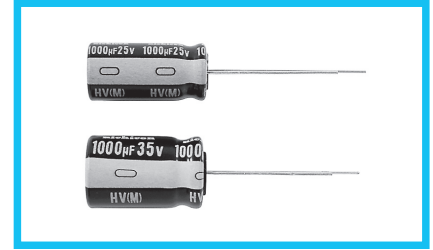
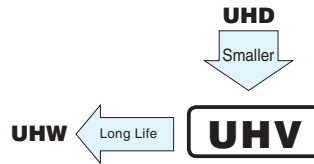

Specifications

Item	Performance Characteristics							
Category Temperature Range	-40 to +105°C							
Rated Voltage Range	6.3 to 35V							
Rated Capacitance Range	150 to 8200µF							
Capacitance Tolerance	±20% at 120Hz, 20°C							
Leakage Current ※	After 2 minutes' application of rated voltage at 20°C, leakage current is not more than 0.01CV(µA).							
Tangent of loss angle (tan δ)	Rated voltage (V)	6.3	10	16	25	35	120Hz 20°C	
	tan δ (max.)	0.21	0.18	0.15	0.13	0.11		
For capacitance of more than 1000µF, add 0.02 for every increase of 1000µF.								
Stability at Low Temperature	Rated voltage (V)	6.3	10	16	25	35	120Hz	
	Impedance ratio (max.)	Z(-25°C) / Z(+20°C)	2	2	2	2		2
		Z(-40°C) / Z(+20°C)	3	3	3	3		3
Endurance	The specifications listed at right shall be met when the capacitors are restored to 20°C after D.C. bias plus rated ripple current is applied for 6000 hours at 105°C, the peak voltage shall not exceed the rated voltage.		Capacitance change	Within ±25% of the initial capacitance value (6.3V 10V : ±30%)				
			tan δ	200% or less than the initial specified value				
			Leakage current	Less than or equal to the initial specified value				
Marking	Printed with white color letter on black sleeve.							

※ I : Leakage Current (µA), C : Rated Capacitance (µF), V : Rated Voltage (V)

Radial Lead Type

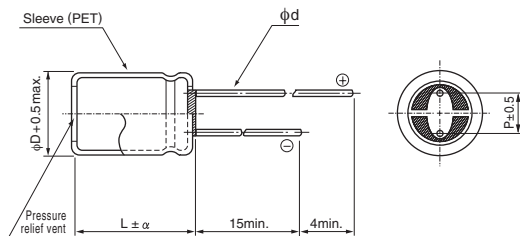

α	(L < 20)	1.5
	(L ≥ 20)	2.0

(mm)				
φD	8	10	12.5	16
P	3.5	5.0	5.0	7.5
φd	0.6	0.6	0.6※	0.8

※ In case L > 25 for the φ12.5 dia. unit, lead dia, φd = 0.8mm.

Type numbering system (Example : 35V 150µF)

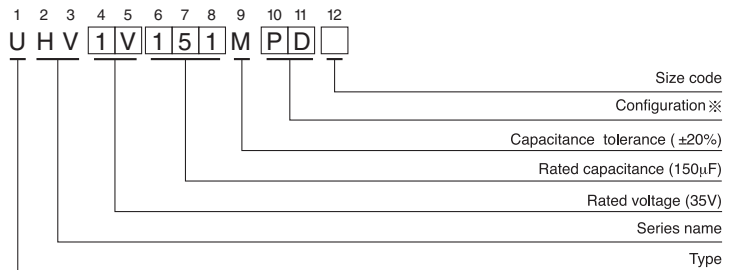

※ Configuration

φ D	Pb-free leadwire Pb-free PET sleeve
8 · 10	PD
12.5 · 16	HD

- Please refer to the Guidelines for Aluminum Electrolytic Capacitors for end seal configuration information.

Frequency coefficient of rated ripple current

Cap. (µF)	Frequency	120Hz	1kHz	10kHz	100kHz or more
150		0.40	0.75	0.90	1.00
220 to 560		0.50	0.85	0.94	1.00
680 to 1800		0.60	0.87	0.95	1.00
2200 to 3900		0.75	0.90	0.95	1.00
4700 to 8200		0.85	0.95	0.98	1.00

● Dimension table in next page.

UHV

■ Dimensions

Rated Voltage (V) (code)	Rated Capacitance (μ F)	Case Size ϕ D \times L (mm)	tan δ	Leakage Current (μ A) (at 20°C after 2 minutes)	Impedance (Ω) max.		Rated Ripple (mA _{rms}) (105°C/100kHz)	Part Number
					20°C/ 100kHz	-10°C/ 100kHz		
6.3 (0J)	680	8 \times 11.5	0.21	42.84	0.059	0.181	900	UHV0J681MPD
	820	8 \times 11.5	0.21	51.66	0.059	0.181	990	UHV0J821MPD
	1000	10 \times 12.5	0.21	63	0.043	0.133	1250	UHV0J102MPD
	1200	10 \times 12.5	0.21	75.6	0.043	0.133	1360	UHV0J122MPD
	1200	8 \times 15	0.21	75.6	0.046	0.143	1330	UHV0J122MPD6
	1500	8 \times 20	0.21	94.5	0.031	0.105	1550	UHV0J152MPD
	1800	10 \times 16	0.21	113.4	0.030	0.095	1815	UHV0J182MPD
	2200	10 \times 20	0.23	138.6	0.019	0.057	2160	UHV0J222MPD
	2700	10 \times 25	0.23	170.1	0.017	0.051	2475	UHV0J272MPD
	3300	12.5 \times 20	0.25	207.9	0.016	0.041	2500	UHV0J332MHD
	3900	12.5 \times 20	0.25	245.7	0.016	0.041	2725	UHV0J392MHD
	4700	12.5 \times 25	0.27	296.1	0.014	0.036	3190	UHV0J472MHD
	5600	12.5 \times 30.5	0.29	352.8	0.012	0.031	3795	UHV0J562MHD
	6800	12.5 \times 35.5	0.31	428.4	0.011	0.029	3925	UHV0J682MHD
	6800	16 \times 20	0.31	428.4	0.014	0.036	3575	UHV0J682MHD6
	8200	16 \times 25	0.35	516.6	0.012	0.033	3990	UHV0J822MHD
10 (1A)	470	8 \times 11.5	0.18	47	0.059	0.181	820	UHV1A471MPD
	680	8 \times 11.5	0.18	68	0.059	0.181	990	UHV1A681MPD
	820	10 \times 12.5	0.18	82	0.043	0.133	1250	UHV1A821MPD
	1000	10 \times 12.5	0.18	100	0.043	0.133	1360	UHV1A102MPD
	1000	8 \times 15	0.18	100	0.046	0.143	1330	UHV1A102MPD6
	1200	10 \times 16	0.18	120	0.030	0.095	1650	UHV1A122MPD
	1500	10 \times 16	0.18	150	0.030	0.095	1815	UHV1A152MPD
	1500	8 \times 20	0.18	150	0.031	0.105	1550	UHV1A152MPD6
	1800	10 \times 20	0.18	180	0.019	0.057	2160	UHV1A182MPD
	2200	10 \times 25	0.20	220	0.017	0.051	2475	UHV1A222MPD
	2700	12.5 \times 20	0.20	270	0.016	0.041	2475	UHV1A272MHD
	3300	12.5 \times 20	0.22	330	0.016	0.041	2725	UHV1A332MHD
	3900	12.5 \times 25	0.22	390	0.014	0.036	3190	UHV1A392MHD
	4700	12.5 \times 30.5	0.24	470	0.012	0.031	3795	UHV1A472MHD
	4700	16 \times 20	0.24	470	0.014	0.036	3575	UHV1A472MHD6
	5600	12.5 \times 35.5	0.26	560	0.011	0.029	3975	UHV1A562MHD
6800	16 \times 25	0.28	680	0.012	0.033	3990	UHV1A682MHD	

For cut leads, formed leads or taped parts, please add the appropriate code after the size code (12th digit).
If there is no size code in the part number, please add size code "1" and then add the appropriate code.

UHV

■ Dimensions

Rated Voltage (V) (code)	Rated Capacitance (μ F)	Case Size ϕ D \times L (mm)	tan δ	Leakage Current (μ A) (at 20°C after 2 minutes)	Impedance (Ω) max.		Rated Ripple (mArms) (105°C/100kHz)	Part Number
					20°C/ 100kHz	-10°C/ 100kHz		
16 (1C)	330	8 \times 11.5	0.15	52.8	0.059	0.181	830	UHV1C331MPD
	470	8 \times 11.5	0.15	75.2	0.059	0.181	990	UHV1C471MPD
	680	10 \times 12.5	0.15	108.8	0.043	0.133	1360	UHV1C681MPD
	680	8 \times 15	0.15	108.8	0.046	0.143	1330	UHV1C681MPD6
	820	10 \times 16	0.15	131.2	0.030	0.095	1650	UHV1C821MPD
	1000	10 \times 16	0.15	160	0.030	0.095	1815	UHV1C102MPD
	1000	8 \times 20	0.15	160	0.031	0.105	1550	UHV1C102MPD6
	1200	10 \times 20	0.15	192	0.019	0.057	1930	UHV1C122MPD
	1500	10 \times 20	0.15	240	0.019	0.057	2160	UHV1C152MPD
	1800	10 \times 25	0.15	288	0.017	0.051	2475	UHV1C182MPD
	2200	12.5 \times 20	0.17	352	0.016	0.041	2725	UHV1C222MHD
	2700	12.5 \times 25	0.17	432	0.014	0.036	3190	UHV1C272MHD
	3300	12.5 \times 30.5	0.19	528	0.012	0.031	3795	UHV1C332MHD
	3300	16 \times 20	0.19	528	0.014	0.036	3575	UHV1C332MHD6
	3900	12.5 \times 35.5	0.19	624	0.011	0.029	3925	UHV1C392MHD
	4700	16 \times 25	0.21	752	0.012	0.033	3990	UHV1C472MHD
25 (1E)	220	8 \times 11.5	0.13	55	0.059	0.181	810	UHV1E221MPD
	270	8 \times 11.5	0.13	67.5	0.059	0.181	900	UHV1E271MPD
	330	8 \times 11.5	0.13	82.5	0.059	0.181	990	UHV1E331MPD
	390	8 \times 15	0.13	97.5	0.046	0.143	1330	UHV1E391MPD
	470	10 \times 12.5	0.13	117.5	0.043	0.133	1360	UHV1E471MPD
	560	8 \times 20	0.13	140	0.031	0.105	1550	UHV1E561MPD
	680	10 \times 16	0.13	170	0.030	0.095	1815	UHV1E681MPD
	820	10 \times 20	0.13	205	0.019	0.057	2160	UHV1E821MPD
	1000	10 \times 25	0.13	250	0.017	0.051	2475	UHV1E102MPD
	1200	12.5 \times 20	0.13	300	0.016	0.041	2475	UHV1E122MHD
	1500	12.5 \times 20	0.13	375	0.016	0.041	2725	UHV1E152MHD
	1800	12.5 \times 25	0.13	450	0.014	0.036	3190	UHV1E182MHD
	2200	12.5 \times 30.5	0.15	550	0.012	0.031	3795	UHV1E222MHD
	2200	16 \times 20	0.15	550	0.014	0.036	3575	UHV1E222MHD6
	2700	12.5 \times 35.5	0.15	675	0.011	0.029	3925	UHV1E272MHD
	3300	16 \times 25	0.17	825	0.012	0.033	3990	UHV1E332MHD

For cut leads, formed leads or taped parts, please add the appropriate code after the size code (12th digit).

If there is no size code in the part number, please add size code "1" and then add the appropriate code.

UHV

■ Dimensions

Rated Voltage (V) (code)	Rated Capacitance (μ F)	Case Size ϕ D \times L (mm)	tan δ	Leakage Current (μ A) (at 20°C after 2 minutes)	Impedance (Ω) max.		Rated Ripple (mA _{rms}) (105°C/100kHz)	Part Number
					20°C/ 100kHz	-10°C/ 100kHz		
35 (1V)	150	8 \times 11.5	0.11	52.5	0.059	0.181	820	UHV1V151MPD
	220	8 \times 11.5	0.11	77	0.059	0.181	990	UHV1V221MPD
	270	8 \times 15	0.11	94.5	0.046	0.143	1330	UHV1V271MPD
	330	10 \times 12.5	0.11	115.5	0.043	0.133	1360	UHV1V331MPD
	390	8 \times 20	0.11	136.5	0.031	0.105	1550	UHV1V391MPD
	470	10 \times 16	0.11	164.5	0.030	0.095	1815	UHV1V471MPD
	560	10 \times 20	0.11	196	0.019	0.057	2160	UHV1V561MPD
	680	10 \times 25	0.11	238	0.017	0.051	2475	UHV1V681MPD
	820	12.5 \times 20	0.11	287	0.016	0.041	2725	UHV1V821MHD
	1000	12.5 \times 20	0.11	350	0.016	0.041	2920	UHV1V102MHD
	1200	12.5 \times 25	0.11	420	0.014	0.041	3190	UHV1V122MHD
	1500	12.5 \times 30.5	0.11	525	0.012	0.031	3795	UHV1V152MHD
	1500	16 \times 20	0.11	525	0.014	0.036	3575	UHV1V152MHD6
	1800	12.5 \times 35.5	0.11	630	0.011	0.029	3925	UHV1V182MHD
2200	16 \times 25	0.13	770	0.012	0.033	3990	UHV1V222MHD	

For cut leads, formed leads or taped parts, please add the appropriate code after the size code (12th digit).
If there is no size code in the part number, please add size code "1" and then add the appropriate code.

- For formed lead or taped product specifications and minimum order quantity, please refer to the Guidelines for Aluminum Electrolytic Capacitors.

UHD

High Ripple Low Impedance



- Lower impedance at high frequency range.
- Smaller case size and high ripple current.
- Compliant to the RoHS directive (2011/65/EU,(EU)2015/863).

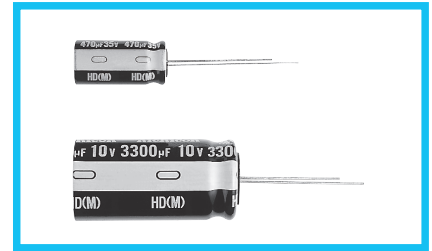
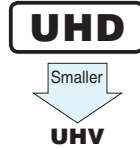

Specifications

Item	Performance Characteristics							
Category Temperature Range	-40 to +105°C							
Rated Voltage Range	6.3 to 50V							
Rated Capacitance Range	100 to 6800μF							
Capacitance Tolerance	±20% at 120Hz, 20°C							
Leakage Current ※	After 2 minutes' application of rated voltage at 20°C, leakage current is not more than 0.01CV (μA).							
Tangent of loss angle (tan δ)	Rated voltage (V)	6.3	10	16	25	35	50	120Hz 20°C
	tan δ (max.)	0.22	0.19	0.16	0.14	0.12	0.10	
For capacitance of more than 1000μF, add 0.02 for every increase of 1000μF.								
Stability at Low Temperature	Rated voltage (V)	6.3	10	16	25	35	50	120Hz
	Impedance ratio (max.)	Z(-25°C) / Z(+20°C)	2	2	2	2	2	
		Z(-40°C) / Z(+20°C)	3	3	3	3	3	3
Endurance	The specifications listed below shall be met when the capacitors are restored to 20°C after D.C. bias plus rated ripple current is applied at 105°C for the condition listed at right. The peak voltage shall not exceed the rated voltage.		φD(mm)		φ8	φ10	≥φ12.5	
			Rated Voltage		6.3~50V	3000hrs.	4000hrs.	5000hrs.
	Capacitance change	Within ±25% of the initial capacitance value						
tan δ	200% or less than the initial specified value							
Leakage current	Less than or equal to the initial specified value							
Marking	Printed with white color letter on black sleeve.							

※ I : Leakage Current (μA), C : Rated Capacitance (μF), V : Rated Voltage (V)

Radial Lead Type

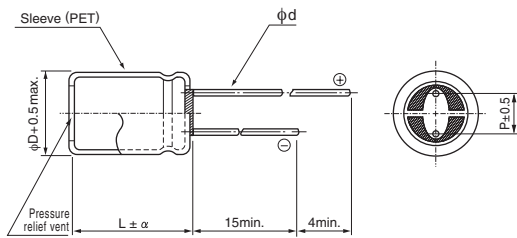

α	(mm)			
	(L < 20)	1.5		
	(L ≥ 20)	2.0		

	φD	8	10	12.5	16
P	3.5	5.0	5.0	7.5	
φd	0.6	0.6	※0.6	0.8	

※ In case L > 25 for the φ12.5 dia. unit, lead dia. φ d = 0.8mm.

Type numbering system (Example : 10V 3300μF)

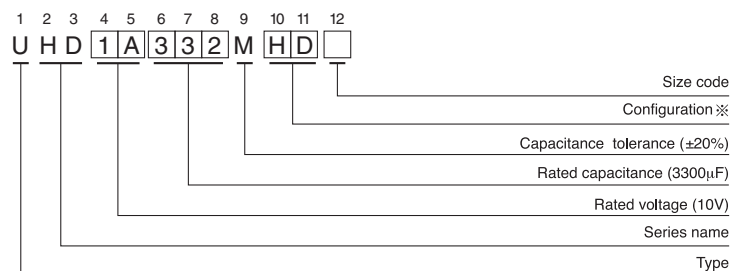

※ Configuration

φ D	Pb-free leadwire Pb-free PET sleeve
8 - 10	PD
12.5 - 16	HD

- Please refer to the Guidelines for Aluminum Electrolytic Capacitors for end seal configuration information.

Frequency coefficient of rated ripple current

Cap. (μF)	Frequency	50Hz	120Hz	1kHz	10kHz	100kHz or more
100 to 330		0.60	0.70	0.85	0.95	1.00
470 to 1000		0.65	0.75	0.90	0.98	1.00
1200 to 6800		0.75	0.80	0.95	1.00	1.00

• Dimension table in next page.

UHD

■ Dimensions

Rated Voltage (V) (code)	Rated Capacitance (μ F)	Case Size ϕ D \times L (mm)	tan δ	Leakage Current (μ A) (at 20°C after 2 minutes)	Impedance (Ω) max.		Rated Ripple (mA _{rms}) (105°C/100kHz)	Part Number
					20°C/ 100kHz	-10°C/ 100kHz		
6.3 (0J)	560	8 \times 11.5	0.22	35.28	0.072	0.22	760	UHD0J561MPD
	820	8 \times 15	0.22	51.66	0.056	0.17	995	UHD0J821MPD
	1000	10 \times 12.5	0.22	63	0.053	0.16	1030	UHD0J102MPD
	1200	8 \times 20	0.22	75.6	0.041	0.13	1250	UHD0J122MPD
	1200	10 \times 16	0.22	75.6	0.038	0.12	1430	UHD0J122MPD6
	1500	10 \times 20	0.22	94.5	0.023	0.069	1820	UHD0J152MPD
	2200	10 \times 25	0.24	138.6	0.022	0.066	2150	UHD0J222MPD
	3300	12.5 \times 20	0.26	207.9	0.021	0.053	2360	UHD0J332MHD
	3900	12.5 \times 25	0.26	245.7	0.018	0.045	2770	UHD0J392MHD
	4700	12.5 \times 30.5	0.28	296.1	0.016	0.041	3290	UHD0J472MHD
	5600	12.5 \times 35.5	0.30	352.8	0.015	0.039	3400	UHD0J562MHD
	5600	16 \times 20	0.30	352.8	0.018	0.045	3140	UHD0J562MHD6
6800	16 \times 25	0.32	428.4	0.016	0.043	3460	UHD0J682MHD	
10 (1A)	470	8 \times 11.5	0.19	47	0.072	0.22	760	UHD1A471MPD
	680	8 \times 15	0.19	68	0.056	0.17	995	UHD1A681MPD
	680	10 \times 12.5	0.19	68	0.053	0.16	1030	UHD1A681MPD6
	1000	8 \times 20	0.19	100	0.041	0.13	1250	UHD1A102MPD
	1000	10 \times 16	0.19	100	0.038	0.12	1430	UHD1A102MPD6
	1200	10 \times 20	0.19	120	0.023	0.069	1820	UHD1A122MPD
	1500	10 \times 25	0.19	150	0.022	0.066	2150	UHD1A152MPD
	2200	12.5 \times 20	0.21	220	0.021	0.053	2360	UHD1A222MHD
	3300	12.5 \times 25	0.23	330	0.018	0.045	2770	UHD1A332MHD
	3900	12.5 \times 30.5	0.23	390	0.016	0.041	3290	UHD1A392MHD
	3900	16 \times 20	0.23	390	0.018	0.045	3140	UHD1A392MHD6
	4700	12.5 \times 35.5	0.25	470	0.015	0.039	3400	UHD1A472MHD
5600	16 \times 25	0.27	560	0.016	0.043	3460	UHD1A562MHD	
16 (1C)	330	8 \times 11.5	0.16	52.8	0.072	0.22	760	UHD1C331MPD
	470	8 \times 15	0.16	75.2	0.056	0.17	995	UHD1C471MPD
	470	10 \times 12.5	0.16	75.2	0.053	0.16	1030	UHD1C471MPD6
	680	8 \times 20	0.16	108.8	0.041	0.13	1250	UHD1C681MPD
	680	10 \times 16	0.16	108.8	0.038	0.12	1430	UHD1C681MPD6
	1000	10 \times 20	0.16	160	0.023	0.069	1820	UHD1C102MPD
	1200	10 \times 25	0.16	192	0.022	0.066	2150	UHD1C122MPD
	1500	12.5 \times 20	0.16	240	0.021	0.053	2360	UHD1C152MHD
	2200	12.5 \times 25	0.18	352	0.018	0.045	2770	UHD1C222MHD
	2700	12.5 \times 30.5	0.18	432	0.016	0.041	3290	UHD1C272MHD
	2700	16 \times 20	0.18	432	0.018	0.045	3140	UHD1C272MHD6
	3300	12.5 \times 35.5	0.20	528	0.015	0.039	3400	UHD1C332MHD
3900	16 \times 25	0.20	624	0.016	0.043	3460	UHD1C392MHD	

For cut leads, formed leads or taped parts, please add the appropriate code after the size code (12th digit).
If there is no size code in the part number, please add size code "1" and then add the appropriate code.

UHD

■ Dimensions

Rated Voltage (V) (code)	Rated Capacitance (μ F)	Case Size ϕ D \times L (mm)	tan δ	Leakage Current (μ A) (at 20°C after 2 minutes)	Impedance (Ω) max.		Rated Ripple (mArms) (105°C/100kHz)	Part Number
					20°C/ 100kHz	-10°C/ 100kHz		
25 (1E)	220	8 \times 11.5	0.14	55	0.072	0.22	760	UHD1E221MPD
	330	8 \times 15	0.14	82.5	0.056	0.17	995	UHD1E331MPD
	330	10 \times 12.5	0.14	82.5	0.053	0.16	1030	UHD1E331MPD6
	470	8 \times 20	0.14	117.5	0.041	0.13	1250	UHD1E471MPD
	470	10 \times 16	0.14	117.5	0.038	0.12	1430	UHD1E471MPD6
	680	10 \times 20	0.14	170	0.023	0.069	1820	UHD1E681MPD
	820	10 \times 25	0.14	205	0.022	0.066	2150	UHD1E821MPD
	1000	12.5 \times 20	0.14	250	0.021	0.053	2360	UHD1E102MHD
	1500	12.5 \times 25	0.14	375	0.018	0.045	2770	UHD1E152MHD
	1800	12.5 \times 30.5	0.14	450	0.016	0.041	3290	UHD1E182MHD
	1800	16 \times 20	0.14	450	0.018	0.045	3140	UHD1E182MHD6
	2200	12.5 \times 35.5	0.16	550	0.015	0.039	3400	UHD1E222MHD
2700	16 \times 25	0.16	675	0.016	0.043	3460	UHD1E272MHD	
35 (1V)	150	8 \times 11.5	0.12	52.5	0.072	0.22	760	UHD1V151MPD
	220	8 \times 15	0.12	77	0.056	0.17	995	UHD1V221MPD
	220	10 \times 12.5	0.12	77	0.053	0.16	1030	UHD1V221MPD6
	270	8 \times 20	0.12	94.5	0.041	0.13	1250	UHD1V271MPD
	330	10 \times 16	0.12	115.5	0.038	0.12	1430	UHD1V331MPD
	470	10 \times 20	0.12	164.5	0.023	0.069	1820	UHD1V471MPD
	560	10 \times 25	0.12	196	0.022	0.066	2150	UHD1V561MPD
	680	12.5 \times 20	0.12	238	0.021	0.053	2360	UHD1V681MHD
	1000	12.5 \times 25	0.12	350	0.018	0.045	2770	UHD1V102MHD
	1200	12.5 \times 30.5	0.12	420	0.016	0.041	3290	UHD1V122MHD
	1200	16 \times 20	0.12	420	0.018	0.045	3140	UHD1V122MHD6
	1500	12.5 \times 35.5	0.12	525	0.015	0.039	3400	UHD1V152MHD
1800	16 \times 25	0.12	630	0.016	0.043	3460	UHD1V182MHD	
50 (1H)	100	8 \times 11.5	0.10	50	0.074	0.22	724	UHD1H101MPD
	120	8 \times 15	0.10	60	0.061	0.18	950	UHD1H121MPD
	150	10 \times 12.5	0.10	75	0.061	0.18	979	UHD1H151MPD
	180	8 \times 20	0.10	90	0.046	0.14	1190	UHD1H181MPD
	220	10 \times 16	0.10	110	0.042	0.12	1370	UHD1H221MPD
	270	10 \times 20	0.10	135	0.030	0.090	1580	UHD1H271MPD
	330	10 \times 25	0.10	165	0.028	0.085	1870	UHD1H331MPD
	470	12.5 \times 20	0.10	235	0.027	0.068	2050	UHD1H471MHD
	560	12.5 \times 25	0.10	280	0.023	0.059	2410	UHD1H561MHD
	680	12.5 \times 30.5	0.10	340	0.021	0.052	2860	UHD1H681MHD
	820	12.5 \times 35.5	0.10	410	0.019	0.051	2960	UHD1H821MHD
	820	16 \times 20	0.10	410	0.023	0.059	2730	UHD1H821MHD6
1000	16 \times 25	0.10	500	0.021	0.056	3010	UHD1H102MHD	

For cut leads, formed leads or taped parts, please add the appropriate code after the size code (12th digit).
If there is no size code in the part number, please add size code "1" and then add the appropriate code.

- For formed lead or taped product specifications and minimum order quantity, please refer to the Guidelines for Aluminum Electrolytic Capacitors.

ALUMINUM ELECTROLYTIC CAPACITORS

UHE

Miniature Sized, Low Impedance,
High Reliability



- Low impedance and high reliability withstanding 6000 hours to 10000 hours.
- Compliant to the RoHS directive (2011/65/EU,(EU)2015/863).

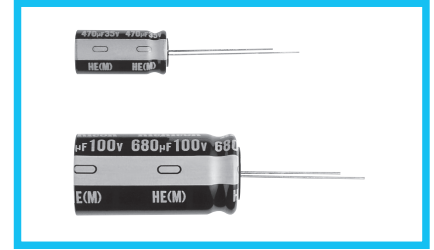

Specifications

Item	Performance Characteristics											
Category Temperature Range	-40 to +105°C											
Rated Voltage Range	6.3 to 100V											
Rated Capacitance Range	27 to 18000μF											
Capacitance Tolerance	±20% at 120Hz, 20°C											
Leakage Current ※	After 2 minutes' application of rated voltage at 20°C, leakage current is not more than 0.01CV (μA).											
Tangent of loss angle (tan δ)	Rated voltage (V)	6.3	10	16	25	35	50	63	100	120Hz 20°C		
	tan δ (max.)	0.22	0.19	0.16	0.14	0.12	0.10	0.09	0.08			
For capacitance of more than 1000μF, add 0.02 for every increase of 1000μF.												
Stability at Low Temperature	Rated voltage (V)	6.3	10	16	25	35	50	63	100	120Hz		
	Impedance ratio (max.)	Z(-25°C) / Z(+20°C)	4	3	2	2	2	2	2		2	
		Z(-40°C) / Z(+20°C)	8	6	4	3	3	3	3		3	
Endurance	The following specifications shall be met when the capacitors are restored to 20°C after D.C. bias plus rated ripple current is applied at 105°C, the peak voltage shall not exceed the rated voltage.											
	Case size	φD = 8, 10			φD ≥ 12.5							
	Rated voltage	6.3 to 10V	6000 hours			8000 hours						
		16 to 100V	7000 hours			10000 hours						
	Capacitance change	Within ±25% of the initial capacitance value										
	tan δ	200% or less than the initial specified value										
Leakage current	Less than or equal to the initial specified value											
Marking	Printed with white color letter on black sleeve.											

※ I : Leakage Current (μA), C : Rated Capacitance (μF), V : Rated Voltage (V)

Radial Lead Type

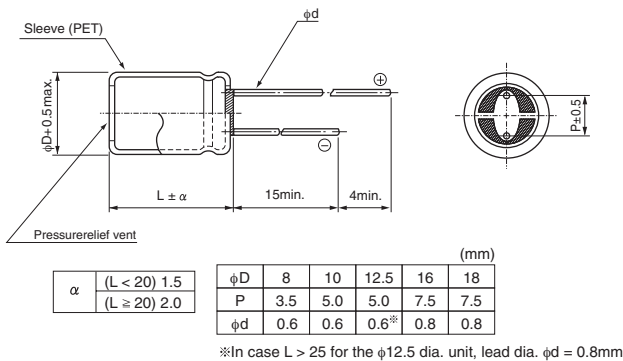

- Please refer to the Guidelines for Aluminum Electrolytic Capacitors for end seal configuration information.

Type numbering system (Example : 10V 1000μF)

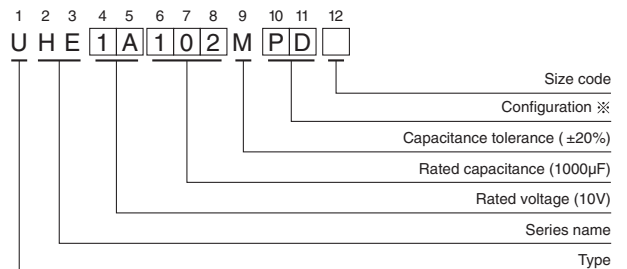

※ Configuration

φ D	Pb-free leadwire Pb-free PET sleeve
8 - 10	PD
12.5 to 18	HD

Frequency coefficient of rated ripple current

Cap. (μF)	Frequency	50Hz	120Hz	300Hz	1kHz	10kHz or more
27		0.45	0.55	0.70	0.90	1.00
39 to 330		0.60	0.70	0.85	0.95	1.00
390 to 1000		0.65	0.75	0.90	0.98	1.00
1200 to 18000		0.75	0.80	0.95	1.00	1.00

● Dimension table in next page.

UHE

■ Dimensions

Rated Voltage (V) (code)	Rated Capacitance (μ F)	Case Size ϕ D×L (mm)	tan δ	Leakage Current (μ A) (at 20°C after 2 minutes)	Impedance (Ω) max.		Rated Ripple (mArms) (105°C/100kHz)	Part Number
					20°C/ 100kHz	-10°C/ 100kHz		
6.3 (0J)	680	8×11.5	0.22	42.84	0.13	0.52	640	UHE0J681MPD
	820	10×12.5	0.22	51.66	0.080	0.32	865	UHE0J821MPD
	1000	8×15	0.22	63	0.087	0.35	840	UHE0J102MPD
	1200	8×20	0.22	75.6	0.069	0.27	1050	UHE0J122MPD
	1200	10×16	0.22	75.6	0.060	0.24	1210	UHE0J122MPD6
	1500	10×20	0.22	94.5	0.046	0.18	1400	UHE0J152MPD
	1800	12.5×15	0.22	113.4	0.049	0.16	1450	UHE0J182MHD
	2200	10×25	0.24	138.6	0.042	0.17	1650	UHE0J222MPD
	2700	10×30.5	0.24	170.1	0.031	0.12	1910	UHE0J272MPD6
	2700	16×15	0.24	170.1	0.042	0.12	1940	UHE0J272MHD
	3300	12.5×20	0.26	207.9	0.035	0.12	1900	UHE0J332MHD
	3900	12.5×25	0.26	245.7	0.027	0.089	2230	UHE0J392MHD
	3900	18×15	0.26	245.7	0.043	0.11	2210	UHE0J392MHD6
	4700	12.5×30.5	0.28	296.1	0.024	0.078	2650	UHE0J472MHD
	5600	12.5×35.5	0.30	352.8	0.020	0.065	2880	UHE0J562MHD
	5600	16×20	0.30	352.8	0.027	0.078	2530	UHE0J562MHD6
	6800	12.5×40	0.32	428.4	0.017	0.056	3350	UHE0J682MHD
	6800	16×25	0.32	428.4	0.021	0.060	2930	UHE0J682MHD6
	6800	18×20	0.32	428.4	0.026	0.067	2860	UHE0J682MHD3
	8200	16×30.5	0.36	516.6	0.017	0.050	3450	UHE0J822MHD
10000	16×35.5	0.40	630	0.015	0.044	3610	UHE0J103MHD	
10000	18×25	0.40	630	0.019	0.049	3140	UHE0J103MHD6	
12000	16×40	0.44	756	0.013	0.038	4080	UHE0J123MHD	
12000	18×30.5	0.44	756	0.015	0.040	4170	UHE0J123MHD6	
15000	18×35.5	0.50	945	0.014	0.038	4220	UHE0J153MHD	
18000	18×40	0.56	1134	0.012	0.032	4280	UHE0J183MHD	
10 (1A)	470	8×11.5	0.19	47	0.13	0.52	640	UHE1A471MPD
	680	8×15	0.19	68	0.087	0.35	840	UHE1A681MPD
	680	10×12.5	0.19	68	0.080	0.32	865	UHE1A681MPD6
	1000	8×20	0.19	100	0.069	0.27	1050	UHE1A102MPD
	1000	10×16	0.19	100	0.060	0.24	1210	UHE1A102MPD6
	1200	10×20	0.19	120	0.046	0.18	1400	UHE1A122MPD
	1500	10×25	0.19	150	0.042	0.17	1650	UHE1A152MPD
	1500	12.5×15	0.19	150	0.049	0.16	1450	UHE1A152MHD6
	2200	10×30.5	0.21	220	0.031	0.12	1910	UHE1A222MPD
	2200	12.5×20	0.21	220	0.035	0.12	1900	UHE1A222MHD6
	2200	16×15	0.21	220	0.042	0.12	1940	UHE1A222MHD3
	2700	18×15	0.21	270	0.043	0.11	2210	UHE1A272MHD
	3300	12.5×25	0.23	330	0.027	0.089	2230	UHE1A332MHD
	3900	12.5×30.5	0.23	390	0.024	0.078	2650	UHE1A392MHD
	3900	16×20	0.23	390	0.027	0.078	2530	UHE1A392MHD6
	4700	12.5×35.5	0.25	470	0.020	0.065	2880	UHE1A472MHD
	5600	12.5×40	0.27	560	0.017	0.056	3350	UHE1A562MHD
	5600	16×25	0.27	560	0.021	0.060	2930	UHE1A562MHD6
	5600	18×20	0.27	560	0.026	0.067	2860	UHE1A562MHD3

For cut leads, formed leads or taped parts, please add the appropriate code after the size code (12th digit).

If there is no size code in the part number, please add size code "1" and then add the appropriate code.

UHE

■ Dimensions

Rated Voltage (V) (code)	Rated Capacitance (μ F)	Case Size ϕ D×L (mm)	tan δ	Leakage Current (μ A) (at 20°C after 2 minutes)	Impedance (Ω) max.		Rated Ripple (mArms) (105°C/100kHz)	Part Number
					20°C/ 100kHz	-10°C/ 100kHz		
10 (1A)	6800	16×30.5	0.29	680	0.017	0.050	3450	UHE1A682MHD
	6800	18×25	0.29	680	0.019	0.049	3140	UHE1A682MHD6
	8200	16×35.5	0.33	820	0.015	0.044	3610	UHE1A822MHD
	8200	18×30.5	0.33	820	0.015	0.040	4170	UHE1A822MHD6
	10000	16×40	0.37	1000	0.013	0.038	4080	UHE1A103MHD
	10000	18×35.5	0.37	1000	0.014	0.038	4220	UHE1A103MHD6
	12000	18×40	0.41	1200	0.012	0.032	4280	UHE1A123MHD
16 (1C)	330	8×11.5	0.16	52.8	0.13	0.52	640	UHE1C331MPD
	470	8×15	0.16	75.2	0.087	0.35	840	UHE1C471MPD
	470	10×12.5	0.16	75.2	0.080	0.32	865	UHE1C471MPD6
	680	8×20	0.16	108.8	0.069	0.27	1050	UHE1C681MPD
	680	10×16	0.16	108.8	0.060	0.24	1210	UHE1C681MPD6
	1000	10×20	0.16	160	0.046	0.18	1400	UHE1C102MPD
	1000	12.5×15	0.16	160	0.049	0.16	1450	UHE1C102MHD6
	1200	10×25	0.16	192	0.042	0.17	1650	UHE1C122MPD
	1500	10×30.5	0.16	240	0.031	0.12	1910	UHE1C152MPD
	1500	12.5×20	0.16	240	0.035	0.12	1900	UHE1C152MHD6
	1500	16×15	0.16	240	0.042	0.12	1940	UHE1C152MHD3
	2200	12.5×25	0.18	352	0.027	0.089	2230	UHE1C222MHD
	2200	18×15	0.18	352	0.043	0.11	2210	UHE1C222MHD6
	2700	12.5×30.5	0.18	432	0.024	0.078	2650	UHE1C272MHD
	2700	16×20	0.18	432	0.027	0.078	2530	UHE1C272MHD6
	3300	12.5×35.5	0.20	528	0.020	0.065	2880	UHE1C332MHD
	3900	12.5×40	0.20	624	0.017	0.056	3350	UHE1C392MHD
	3900	16×25	0.20	624	0.021	0.060	2930	UHE1C392MHD6
	3900	16×20	0.20	624	0.026	0.067	2860	UHE1C392MHD3
	4700	16×30.5	0.22	752	0.017	0.050	3450	UHE1C472MHD
	4700	18×25	0.22	752	0.019	0.049	3140	UHE1C472MHD6
	5600	16×35.5	0.24	896	0.015	0.044	3610	UHE1C562MHD
	5600	18×30.5	0.24	896	0.015	0.040	4170	UHE1C562MHD6
6800	16×40	0.26	1088	0.013	0.038	4080	UHE1C682MHD	
8200	18×35.5	0.30	1312	0.014	0.038	4220	UHE1C822MHD	
10000	18×40	0.34	1600	0.012	0.032	4280	UHE1C103MHD	
25 (1E)	220	8×11.5	0.14	55	0.13	0.52	640	UHE1E221MPD
	330	8×15	0.14	82.5	0.087	0.35	840	UHE1E331MPD
	330	10×12.5	0.14	82.5	0.080	0.32	865	UHE1E331MPD6
	470	8×20	0.14	117.5	0.069	0.27	1050	UHE1E471MPD
	470	10×16	0.14	117.5	0.060	0.24	1210	UHE1E471MPD6
	680	10×20	0.14	170	0.046	0.18	1400	UHE1E681MPD
	680	12.5×15	0.14	170	0.049	0.16	1450	UHE1E681MHD6
	820	10×25	0.14	205	0.042	0.17	1650	UHE1E821MPD
	1000	10×30.5	0.14	250	0.031	0.12	1910	UHE1E102MPD
	1000	12.5×20	0.14	250	0.035	0.12	1900	UHE1E102MHD6
	1000	16×15	0.14	250	0.042	0.12	1940	UHE1E102MHD3
	1200	18×15	0.14	300	0.043	0.11	2210	UHE1E122MHD

For cut leads, formed leads or taped parts, please add the appropriate code after the size code (12th digit).

If there is no size code in the part number, please add size code "1" and then add the appropriate code.

UHE

■ Dimensions

Rated Voltage (V) (code)	Rated Capacitance (μF)	Case Size φD×L (mm)	tan δ	Leakage Current (μA) (at 20°C after 2 minutes)	Impedance (Ω) max.		Rated Ripple (mA _{rms}) (105°C/100kHz)	Part Number
					20°C/100kHz	-10°C/100kHz		
25 (1E)	1500	12.5×25	0.14	375	0.027	0.089	2230	UHE1E152MHD
	1800	12.5×30.5	0.14	450	0.024	0.078	2650	UHE1E182MHD
	1800	16×20	0.14	450	0.027	0.078	2530	UHE1E182MHD6
	2200	12.5×35.5	0.16	550	0.020	0.065	2880	UHE1E222MHD
	2200	18×20	0.16	550	0.026	0.067	2860	UHE1E222MHD6
	2700	12.5×40	0.16	675	0.017	0.056	3350	UHE1E272MHD
	2700	16×25	0.16	675	0.021	0.060	2930	UHE1E272MHD6
	3300	16×30.5	0.18	825	0.017	0.050	3450	UHE1E332MHD
	3300	18×25	0.18	825	0.019	0.049	3140	UHE1E332MHD6
	3900	16×35.5	0.18	975	0.015	0.044	3610	UHE1E392MHD
	3900	18×30.5	0.18	975	0.015	0.040	4170	UHE1E392MHD6
	4700	16×40	0.20	1175	0.013	0.038	4080	UHE1E472MHD
	4700	18×35.5	0.20	1175	0.014	0.038	4220	UHE1E472MHD6
	5600	18×40	0.22	1400	0.012	0.032	4280	UHE1E562MHD
35 (1V)	100	8×11.5	0.12	35	0.13	0.52	640	UHE1V101MPD
	150	8×11.5	0.12	52.5	0.13	0.52	640	UHE1V151MPD
	220	8×15	0.12	77	0.087	0.35	840	UHE1V221MPD
	220	10×12.5	0.12	77	0.080	0.32	865	UHE1V221MPD6
	270	8×20	0.12	94.5	0.069	0.27	1050	UHE1V271MPD
	330	10×16	0.12	115.5	0.060	0.24	1210	UHE1V331MPD
	470	10×20	0.12	164.5	0.046	0.18	1400	UHE1V471MPD
	470	12.5×15	0.12	164.5	0.049	0.16	1450	UHE1V471MHD6
	560	10×25	0.12	196	0.042	0.17	1650	UHE1V561MPD
	680	10×30.5	0.12	238	0.031	0.12	1910	UHE1V681MPD
	680	12.5×20	0.12	238	0.035	0.12	1900	UHE1V681MHD6
	680	16×15	0.12	238	0.042	0.12	1940	UHE1V681MHD3
	1000	12.5×25	0.12	350	0.027	0.089	2230	UHE1V102MHD
	1000	18×15	0.12	350	0.043	0.11	2210	UHE1V102MHD6
	1200	12.5×30.5	0.12	420	0.024	0.078	2650	UHE1V122MHD
	1200	16×20	0.12	420	0.027	0.078	2530	UHE1V122MHD6
	1500	12.5×35.5	0.12	525	0.020	0.065	2880	UHE1V152MHD
	1800	12.5×40	0.12	630	0.017	0.056	3350	UHE1V182MHD
	1800	16×25	0.12	630	0.021	0.060	2930	UHE1V182MHD6
	1800	18×20	0.12	630	0.026	0.067	2860	UHE1V182MHD3
	2200	16×30.5	0.14	770	0.017	0.050	3450	UHE1V222MHD
	2200	18×25	0.14	770	0.019	0.049	3140	UHE1V222MHD6
	2700	16×35.5	0.14	945	0.015	0.044	3610	UHE1V272MHD
	2700	18×30.5	0.14	945	0.015	0.040	4170	UHE1V272MHD6
	3300	16×40	0.16	1155	0.013	0.038	4080	UHE1V332MHD
	3300	18×35.5	0.16	1155	0.014	0.038	4220	UHE1V332MHD6
3900	18×40	0.16	1365	0.012	0.032	4280	UHE1V392MHD	

For cut leads, formed leads or taped parts, please add the appropriate code after the size code (12th digit).
 If there is no size code in the part number, please add size code "1" and then add the appropriate code.

UHE

■ Dimensions

Rated Voltage (V) (code)	Rated Capacitance (μ F)	Case Size ϕ D \times L (mm)	tan δ	Leakage Current (μ A) (at 20°C after 2 minutes)	Impedance (Ω) max.		Rated Ripple (mArms) (105°C/100kHz)	Part Number
					20°C/ 100kHz	-10°C/ 100kHz		
50 (1H)	100	8 \times 11.5	0.10	50	0.17	0.68	555	UHE1H101MPD
	120	8 \times 15	0.10	60	0.12	0.48	730	UHE1H121MPD
	150	10 \times 12.5	0.10	75	0.12	0.48	760	UHE1H151MPD
	180	8 \times 20	0.10	90	0.091	0.36	910	UHE1H181MPD
	220	10 \times 16	0.10	110	0.084	0.34	1050	UHE1H221MPD
	270	10 \times 20	0.10	135	0.060	0.24	1220	UHE1H271MPD
	270	12.5 \times 15	0.10	135	0.061	0.20	1260	UHE1H271MHD6
	330	10 \times 25	0.10	165	0.055	0.22	1440	UHE1H331MPD
	330	10 \times 20	0.10	165	0.060	0.24	1220	UHE1H331MPD6
	470	10 \times 30.5	0.10	235	0.043	0.17	1690	UHE1H471MPD
	470	12.5 \times 20	0.10	235	0.045	0.15	1660	UHE1H471MHD6
	470	16 \times 15	0.10	235	0.055	0.17	1690	UHE1H471MHD3
	560	12.5 \times 25	0.10	280	0.034	0.11	1950	UHE1H561MHD
	560	18 \times 15	0.10	280	0.054	0.15	1930	UHE1H561MHD6
	680	12.5 \times 30.5	0.10	340	0.030	0.10	2310	UHE1H681MHD
	820	12.5 \times 35.5	0.10	410	0.025	0.083	2510	UHE1H821MHD
	820	16 \times 20	0.10	410	0.034	0.10	2210	UHE1H821MHD6
	1000	12.5 \times 40	0.10	500	0.021	0.069	2920	UHE1H102MHD
	1000	16 \times 25	0.10	500	0.025	0.075	2555	UHE1H102MHD6
	1000	18 \times 20	0.10	500	0.036	0.097	2490	UHE1H102MHD3
	1200	16 \times 30.5	0.10	600	0.022	0.066	3010	UHE1H122MHD
	1200	18 \times 25	0.10	600	0.026	0.070	2740	UHE1H122MHD6
	1500	16 \times 35.5	0.10	750	0.019	0.057	3150	UHE1H152MHD
	1800	16 \times 40	0.10	900	0.016	0.048	3710	UHE1H182MHD
1800	18 \times 30.5	0.10	900	0.021	0.057	3635	UHE1H182MHD6	
2200	18 \times 35.5	0.12	1100	0.017	0.046	3680	UHE1H222MHD6	
2700	18 \times 40	0.12	1350	0.014	0.038	3800	UHE1H272MHD	
63 (1J)	47	8 \times 11.5	0.09	29.61	0.63	2.80	260	UHE1J470MPD
	56	8 \times 11.5	0.09	35.28	0.63	2.80	260	UHE1J560MPD
	82	8 \times 15	0.09	51.66	0.45	2.10	335	UHE1J820MPD
	82	10 \times 12.5	0.09	51.66	0.43	1.80	325	UHE1J820MPD6
	120	8 \times 20	0.09	75.6	0.33	1.60	408	UHE1J121MPD
	120	10 \times 16	0.09	75.6	0.31	1.50	400	UHE1J121MPD6
	180	10 \times 20	0.09	113.4	0.21	0.94	518	UHE1J181MPD
	180	12.5 \times 15	0.09	113.4	0.23	1.10	527	UHE1J181MHD6
	220	10 \times 25	0.09	138.6	0.20	0.84	595	UHE1J221MPD
	270	10 \times 30.5	0.09	170.1	0.15	0.71	740	UHE1J271MPD
	270	12.5 \times 20	0.09	170.1	0.16	0.64	765	UHE1J271MHD6
	270	16 \times 15	0.09	170.1	0.14	0.66	895	UHE1J271MHD3
	330	12.5 \times 25	0.09	207.9	0.12	0.45	875	UHE1J331MHD
	390	18 \times 15	0.09	245.7	0.12	0.50	1030	UHE1J391MHD
	470	12.5 \times 30.5	0.09	296.1	0.10	0.42	1010	UHE1J471MHD
	470	16 \times 20	0.09	296.1	0.091	0.38	1130	UHE1J471MHD6
	560	12.5 \times 35.5	0.09	352.8	0.083	0.35	1140	UHE1J561MHD
	560	16 \times 25	0.09	352.8	0.073	0.27	1350	UHE1J561MHD6

For cut leads, formed leads or taped parts, please add the appropriate code after the size code (12th digit).

If there is no size code in the part number, please add size code "1" and then add the appropriate code.

UHE

■ Dimensions

Rated Voltage (V) (code)	Rated Capacitance (μ F)	Case Size ϕ D \times L (mm)	tan δ	Leakage Current (μ A) (at 20°C after 2 minutes)	Impedance (Ω) max.		Rated Ripple (mArms) (105°C/100kHz)	Part Number
					20°C/ 100kHz	-10°C/ 100kHz		
63 (1J)	680	12.5 \times 40	0.09	428.4	0.071	0.30	1280	UHE1J681MHD
	680	18 \times 20	0.09	428.4	0.080	0.30	1300	UHE1J681MHD6
	820	16 \times 30.5	0.09	516.6	0.054	0.20	1650	UHE1J821MHD
	820	18 \times 25	0.09	516.6	0.057	0.21	1560	UHE1J821MHD6
	1000	16 \times 35.5	0.09	630	0.045	0.17	1900	UHE1J102MHD
	1000	18 \times 30.5	0.09	630	0.047	0.17	1720	UHE1J102MHD6
	1200	16 \times 40	0.09	756	0.040	0.15	2130	UHE1J122MHD
	1200	18 \times 35.5	0.09	756	0.040	0.15	1890	UHE1J122MHD6
	1500	18 \times 40	0.09	945	0.036	0.13	2470	UHE1J152MHD
100 (2A)	27	8 \times 11.5	0.08	27	0.63	2.80	260	UHE2A270MPD
	39	8 \times 15	0.08	39	0.45	2.10	335	UHE2A390MPD
	47	10 \times 12.5	0.08	47	0.43	1.80	325	UHE2A470MPD
	56	8 \times 20	0.08	56	0.33	1.60	408	UHE2A560MPD
	68	10 \times 16	0.08	68	0.31	1.50	400	UHE2A680MPD
	82	10 \times 20	0.08	82	0.21	0.94	518	UHE2A820MPD
	82	12.5 \times 15	0.08	82	0.23	1.10	527	UHE2A820MHD6
	100	10 \times 25	0.08	100	0.20	0.84	595	UHE2A101MPD
	100	12.5 \times 20	0.08	100	0.20	0.84	740	UHE2A101MHD6
	120	10 \times 30.5	0.08	120	0.15	0.71	740	UHE2A121MPD
	120	12.5 \times 20	0.08	120	0.16	0.64	765	UHE2A121MHD6
	150	16 \times 15	0.08	150	0.14	0.66	895	UHE2A151MHD
	180	12.5 \times 25	0.08	180	0.12	0.45	875	UHE2A181MHD
	180	18 \times 15	0.08	180	0.12	0.50	1030	UHE2A181MHD6
	220	12.5 \times 30.5	0.08	220	0.10	0.42	1010	UHE2A221MHD
	220	16 \times 20	0.08	220	0.091	0.38	1130	UHE2A221MHD6
	270	12.5 \times 35.5	0.08	270	0.083	0.35	1140	UHE2A271MHD
	270	16 \times 25	0.08	270	0.073	0.27	1350	UHE2A271MHD6
	330	12.5 \times 40	0.08	330	0.071	0.30	1280	UHE2A331MHD
	330	18 \times 20	0.08	330	0.080	0.30	1300	UHE2A331MHD6
	390	16 \times 30.5	0.08	390	0.054	0.20	1650	UHE2A391MHD
	390	18 \times 25	0.08	390	0.057	0.21	1560	UHE2A391MHD6
	470	16 \times 35.5	0.08	470	0.045	0.17	1900	UHE2A471MHD
	470	18 \times 30.5	0.08	470	0.047	0.17	1720	UHE2A471MHD6
560	16 \times 40	0.08	560	0.040	0.15	2130	UHE2A561MHD	
680	18 \times 35.5	0.08	680	0.040	0.15	1890	UHE2A681MHD	
820	18 \times 40	0.08	820	0.036	0.13	2470	UHE2A821MHD	

For cut leads, formed leads or taped parts, please add the appropriate code after the size code (12th digit).
If there is no size code in the part number, please add size code "1" and then add the appropriate code.

- For formed lead or taped product specifications and minimum order quantity, please refer to the Guidelines for Aluminum Electrolytic Capacitors.

ALUMINUM ELECTROLYTIC CAPACITORS

UHW

Miniature Sized, High Ripple Current,
High Reliability



- Lower impedance at high frequency range.
- Smaller case size and high ripple current.
- Compliant to the RoHS directive (2011/65/EU,(EU)2015/863).

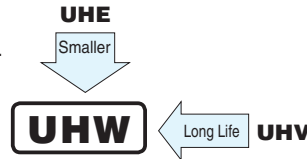

Specifications

Item	Performance Characteristics											
Category Temperature Range	-40 to +105°C											
Rated Voltage Range	6.3 to 100V											
Rated Capacitance Range	33 to 15000µF											
Capacitance Tolerance	±20% at 120Hz, 20°C											
Leakage Current ※	After 2 minutes' application of rated voltage at 20°C, leakage current is not more than 0.01CV (µA)											
Tangent of loss angle (tan δ)	Rated voltage (V)	6.3	10	16	25	35	50	63	80	100	120Hz 20°C	
	tan δ (max.)	0.21	0.18	0.15	0.13	0.11	0.10	0.09	0.09	0.08		
For capacitance of more than 1000µF, add 0.02 for every increase of 1000µF.												
Stability at Low Temperature	Rated voltage (V)	6.3	10	16	25	35	50	63	80	100	120Hz	
	Impedance ratio (max.)	Z(-25°C) / Z(+20°C)	2	2	2	2	2	2	2	2		2
		Z(-40°C) / Z(+20°C)	5	5	4	4	4	4	3	3		3
		φD ≤ 6.3	3	3	3	3	3	3	3	3		3
Endurance	The following specifications shall be met when the capacitors are restored to 20°C after D.C. bias plus rated ripple current is applied at 105°C, the peak voltage shall not exceed the rated voltage.											
	Case size	8×11.5		8×15, 8×20		φD ≥ 10						
	Rated voltage (V)	6.3V	8000 hours		9000 hours		10000 hours					
		10 to 50V	9000 hours		10000 hours		10000 hours					
		63 to 100V	10000 hours		11000 hours		12000 hours					
	Capacitance change	Within ±25% of the initial capacitance value (6.3V 10V : ±30%)										
	tan δ	200% or less than the initial specified value										
Leakage current	Less than or equal to the initial specified value											
Marking	Printed with white color letter on black sleeve.											

Radial Lead Type

※ I : Leakage Current (µA), C : Rated Capacitance (µF), V : Rated Voltage (V)

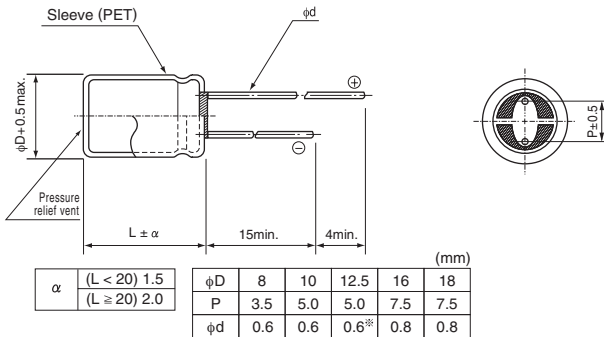

- Please refer to the Guidelines for Aluminum Electrolytic Capacitors for end seal configuration information.

Frequency coefficient of rated ripple current

Cap. (µF)	Frequency	120Hz	1kHz	10kHz	10kHz or more
33		0.40	0.70	0.90	1.00
47 to 180		0.40	0.75	0.90	1.00
220 to 560		0.50	0.85	0.94	1.00
680 to 1800		0.60	0.87	0.95	1.00
2200 to 3900		0.75	0.90	0.95	1.00
4700 to 15000		0.85	0.95	0.98	1.00

• Dimension table in next page.

Type numbering system (Example : 16V 2200µF)

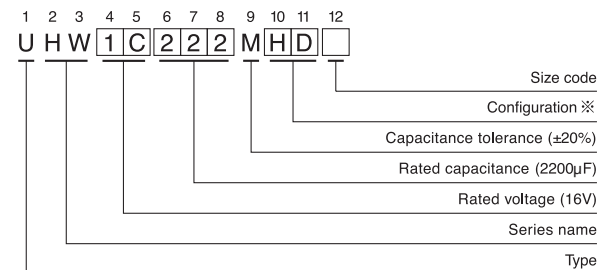

※ Configuration

φ D	Pb-free leadwire Pb-free PET sleeve
8 - 10	PD
12.5 to 18	HD

UHW

■ Dimensions

Rated Voltage (V) (code)	Rated Capacitance (μ F)	Case Size ϕ D×L (mm)	tan δ	Leakage Current (μ A) (at 20°C after 2 minutes)	Impedance (Ω) max.		Rated Ripple (mA _{rms}) (105°C/100kHz)	Part Number
					20°C/ 100kHz	-10°C/ 100kHz		
6.3 (0J)	820	8×11.5	0.21	51.66	0.10	0.36	1200	UHW0J821MPD
	1000	8×15	0.21	63	0.054	0.17	1600	UHW0J102MPD
	1200	10×12.5	0.21	75.6	0.048	0.15	1700	UHW0J122MPD
	1500	8×20	0.21	94.5	0.038	0.12	1960	UHW0J152MPD
	1800	10×16	0.21	113.4	0.030	0.090	2000	UHW0J182MPD
	2200	10×20	0.23	138.6	0.020	0.060	2500	UHW0J222MPD
	2700	10×20	0.23	170.1	0.020	0.060	2500	UHW0J272MPD
	3300	10×25	0.25	207.9	0.017	0.051	2900	UHW0J332MPD
	3900	12.5×20	0.25	245.7	0.017	0.051	2600	UHW0J392MHD
	4700	12.5×25	0.27	296.1	0.015	0.045	3200	UHW0J472MHD
	5600	12.5×30.5	0.29	352.8	0.012	0.036	3795	UHW0J562MHD
	5600	12.5×25	0.29	352.8	0.015	0.045	3200	UHW0J562MHD6
	6800	12.5×30.5	0.31	428.4	0.012	0.033	3795	UHW0J682MHD
	6800	16×20	0.31	428.4	0.015	0.045	3575	UHW0J682MHD6
	8200	16×25	0.35	516.6	0.013	0.039	3810	UHW0J822MHD
	10000	16×25	0.39	630	0.013	0.039	3810	UHW0J103MHD
12000	16×30.5	0.43	756	0.011	0.033	4000	UHW0J123MHD	
15000	16×35.5	0.49	945	0.010	0.030	4200	UHW0J153MHD	
10 (1A)	560	8×11.5	0.18	56	0.10	0.36	1200	UHW1A561MPD
	820	8×15	0.18	82	0.054	0.17	1600	UHW1A821MPD
	1000	10×12.5	0.18	100	0.048	0.15	1700	UHW1A102MPD
	1200	8×20	0.18	120	0.038	0.12	1960	UHW1A122MPD6
	1200	10×16	0.18	120	0.030	0.090	2000	UHW1A122MPD
	1500	10×16	0.18	150	0.030	0.090	2000	UHW1A152MPD
	1800	10×20	0.18	180	0.020	0.060	2500	UHW1A182MPD
	2200	10×25	0.20	220	0.017	0.051	2900	UHW1A222MPD
	2700	12.5×20	0.20	270	0.017	0.051	2600	UHW1A272MHD
	3300	12.5×20	0.22	330	0.017	0.051	2600	UHW1A332MHD
	3900	12.5×25	0.22	390	0.015	0.045	3200	UHW1A392MHD
	4700	12.5×30.5	0.24	470	0.012	0.036	3795	UHW1A472MHD
	4700	16×20	0.24	470	0.015	0.045	3575	UHW1A472MHD6
	5600	12.5×35.5	0.26	560	0.011	0.033	4120	UHW1A562MHD
	5600	16×25	0.26	560	0.013	0.039	3810	UHW1A562MHD6
	6800	16×25	0.28	680	0.013	0.039	3810	UHW1A682MHD
8200	16×30.5	0.32	820	0.011	0.033	4000	UHW1A822MHD	
10000	16×30.5	0.36	1000	0.011	0.033	4000	UHW1A103MHD	
12000	16×35.5	0.40	1200	0.010	0.030	4200	UHW1A123MHD	
16 (1C)	470	8×11.5	0.15	75.2	0.10	0.36	1200	UHW1C471MPD
	560	8×15	0.15	89.6	0.054	0.17	1600	UHW1C561MPD
	680	10×12.5	0.15	108.8	0.048	0.15	1700	UHW1C681MPD
	820	8×20	0.15	131.2	0.038	0.12	1960	UHW1C821MPD6
	820	10×16	0.15	131.2	0.030	0.090	2000	UHW1C821MPD
	1000	8×20	0.15	160	0.038	0.12	1960	UHW1C102MPD6
	1000	10×16	0.15	160	0.030	0.090	2000	UHW1C102MPD
	1200	10×20	0.15	192	0.020	0.060	2500	UHW1C122MPD

For cut leads, formed leads or taped parts, please add the appropriate code after the size code (12th digit).

If there is no size code in the part number, please add size code "1" and then add the appropriate code.

UHW

■ Dimensions

Rated Voltage (V) (code)	Rated Capacitance (μ F)	Case Size ϕ D \times L (mm)	tan δ	Leakage Current (μ A) (at 20°C after 2 minutes)	Impedance (Ω) max.		Rated Ripple (mArms) (105°C/100kHz)	Part Number
					20°C/ 100kHz	-10°C/ 100kHz		
16 (1C)	1200	10 \times 16	0.15	192	0.030	0.090	2000	UHW1C122MPD6
	1500	10 \times 20	0.15	240	0.020	0.060	2500	UHW1C152MPD
	1800	10 \times 25	0.15	288	0.017	0.051	2900	UHW1C182MPD
	2200	12.5 \times 20	0.17	352	0.017	0.051	2600	UHW1C222MHD
	2700	12.5 \times 25	0.17	432	0.015	0.045	3200	UHW1C272MHD
	3300	12.5 \times 25	0.19	528	0.015	0.045	3200	UHW1C332MHD
	3300	16 \times 20	0.19	528	0.015	0.045	3575	UHW1C332MHD6
	3900	12.5 \times 30.5	0.19	624	0.012	0.036	3795	UHW1C392MHD
	3900	16 \times 20	0.19	624	0.015	0.045	3575	UHW1C392MHD6
	4700	12.5 \times 35.5	0.21	752	0.011	0.033	4120	UHW1C472MHD
	4700	16 \times 25	0.21	752	0.013	0.039	3810	UHW1C472MHD6
	5600	16 \times 25	0.23	896	0.013	0.039	3810	UHW1C562MHD
	6800	16 \times 30.5	0.25	1088	0.011	0.033	4000	UHW1C682MHD
	8200	16 \times 35.5	0.29	1312	0.010	0.030	4200	UHW1C822MHD
25 (1E)	330	8 \times 11.5	0.13	82.5	0.10	0.36	1200	UHW1E331MPD
	390	8 \times 15	0.13	97.5	0.054	0.17	1600	UHW1E391MPD
	470	10 \times 12.5	0.13	117.5	0.048	0.15	1700	UHW1E471MPD
	560	8 \times 20	0.13	140	0.038	0.12	1960	UHW1E561MPD
	680	10 \times 16	0.13	170	0.030	0.090	2000	UHW1E681MPD
	820	10 \times 20	0.13	205	0.020	0.060	2500	UHW1E821MPD
	820	10 \times 16	0.13	205	0.030	0.090	2000	UHW1E821MPD6
	1000	10 \times 20	0.13	250	0.020	0.060	2500	UHW1E102MPD
	1200	10 \times 25	0.13	300	0.017	0.051	2900	UHW1E122MPD
	1500	12.5 \times 20	0.13	375	0.017	0.051	2600	UHW1E152MHD
	1800	12.5 \times 25	0.13	450	0.015	0.045	3200	UHW1E182MHD
	2200	12.5 \times 25	0.15	550	0.015	0.045	3200	UHW1E222MHD
	2200	16 \times 20	0.15	550	0.015	0.045	3575	UHW1E222MHD6
	2700	12.5 \times 30.5	0.15	675	0.012	0.036	3795	UHW1E272MHD
	2700	16 \times 20	0.15	675	0.015	0.045	3575	UHW1E272MHD6
	3300	12.5 \times 35.5	0.17	825	0.011	0.033	4120	UHW1E332MHD
	3300	16 \times 25	0.17	825	0.013	0.039	3810	UHW1E332MHD6
3900	16 \times 25	0.17	975	0.013	0.039	3810	UHW1E392MHD	
4700	16 \times 30.5	0.19	1175	0.011	0.033	4000	UHW1E472MHD	
5600	16 \times 35.5	0.21	1400	0.010	0.030	4200	UHW1E562MHD	
35 (1V)	180	8 \times 11.5	0.11	63	0.10	0.36	1200	UHW1V181MPD
	220	8 \times 15	0.11	77	0.054	0.17	1600	UHW1V221MPD
	270	8 \times 15	0.11	94.5	0.054	0.17	1600	UHW1V271MPD
	270	10 \times 12.5	0.11	94.5	0.048	0.15	1700	UHW1V271MPD6
	330	10 \times 12.5	0.11	115.5	0.048	0.15	1700	UHW1V331MPD
	390	8 \times 20	0.11	136.5	0.038	0.12	1960	UHW1V391MPD6
	390	10 \times 16	0.11	136.5	0.030	0.090	2000	UHW1V391MPD
	470	10 \times 16	0.11	164.5	0.030	0.090	2000	UHW1V471MPD
	560	10 \times 20	0.11	196	0.020	0.060	2500	UHW1V561MPD
	680	10 \times 25	0.11	238	0.017	0.051	2900	UHW1V681MPD
	680	10 \times 20	0.11	238	0.020	0.060	2500	UHW1V681MPD6

For cut leads, formed leads or taped parts, please add the appropriate code after the size code (12th digit).

If there is no size code in the part number, please add size code "1" and then add the appropriate code.

UHW

■ Dimensions

Rated Voltage (V) (code)	Rated Capacitance (μ F)	Case Size ϕ D \times L (mm)	tan δ	Leakage Current (μ A) (at 20°C after 2 minutes)	Impedance (Ω) max.		Rated Ripple (mArms) (105°C/100kHz)	Part Number
					20°C/ 100kHz	-10°C/ 100kHz		
35 (1V)	820	10 \times 25	0.11	287	0.017	0.051	2900	UHW1V821MPD
	820	12.5 \times 20	0.11	287	0.017	0.051	2600	UHW1V821MHD6
	1000	12.5 \times 20	0.11	350	0.017	0.051	2600	UHW1V102MHD
	1200	12.5 \times 25	0.11	420	0.015	0.045	3200	UHW1V122MHD
	1500	16 \times 20	0.11	525	0.015	0.045	3575	UHW1V152MHD
	1800	12.5 \times 30.5	0.11	630	0.012	0.036	3795	UHW1V182MHD
	1800	16 \times 25	0.11	630	0.013	0.039	3810	UHW1V182MHD6
	2200	12.5 \times 35.5	0.13	770	0.011	0.033	4120	UHW1V222MHD
	2200	16 \times 25	0.13	770	0.013	0.039	3810	UHW1V222MHD6
	3300	16 \times 30.5	0.15	1155	0.011	0.033	4000	UHW1V332MHD
	3900	16 \times 35.5	0.15	1365	0.010	0.030	4200	UHW1V392MHD
50 (1H)	100	8 \times 11.5	0.10	50	0.10	0.36	1200	UHW1H101MPD
	120	8 \times 11.5	0.10	60	0.10	0.36	1200	UHW1H121MPD
	150	8 \times 15	0.10	75	0.054	0.17	1600	UHW1H151MPD
	180	10 \times 12.5	0.10	90	0.048	0.15	1700	UHW1H181MPD
	220	10 \times 12.5	0.10	110	0.048	0.15	1700	UHW1H221MPD6
	220	10 \times 16	0.10	110	0.042	0.126	1650	UHW1H221MPD
	270	8 \times 20	0.10	135	0.038	0.12	1960	UHW1H271MPD6
	270	10 \times 20	0.10	135	0.030	0.090	2060	UHW1H271MPD
	330	10 \times 20	0.10	165	0.030	0.090	2060	UHW1H331MPD
	390	10 \times 25	0.10	195	0.028	0.084	2420	UHW1H391MPD
	390	10 \times 20	0.10	195	0.030	0.090	2060	UHW1H391MPD6
	470	10 \times 25	0.10	235	0.028	0.084	2420	UHW1H471MPD
	470	12.5 \times 20	0.10	235	0.027	0.081	2300	UHW1H471MHD6
	560	12.5 \times 20	0.10	280	0.027	0.081	2300	UHW1H561MHD
	680	12.5 \times 25	0.10	340	0.023	0.069	2800	UHW1H681MHD
	820	12.5 \times 25	0.10	410	0.023	0.069	2800	UHW1H821MHD
	820	16 \times 20	0.10	410	0.023	0.069	3070	UHW1H821MHD6
	1000	12.5 \times 30.5	0.10	500	0.020	0.060	3500	UHW1H102MHD
	1000	16 \times 25	0.10	500	0.021	0.063	3270	UHW1H102MHD6
	1200	16 \times 25	0.10	600	0.021	0.063	3270	UHW1H122MHD
	1500	12.5 \times 35.5	0.10	750	0.019	0.057	3810	UHW1H152MHD
1500	16 \times 25	0.10	750	0.021	0.063	3270	UHW1H152MHD6	
1800	16 \times 30.5	0.10	900	0.019	0.057	3430	UHW1H182MHD	
2200	16 \times 30.5	0.12	1100	0.019	0.057	3430	UHW1H222MHD	
2700	16 \times 35.5	0.12	1350	0.018	0.054	3600	UHW1H272MHD	
63 (1J)	68	8 \times 11.5	0.09	42.84	0.29	1.30	950	UHW1J680MPD
	82	8 \times 11.5	0.09	51.66	0.29	1.30	950	UHW1J820MPD
	100	8 \times 15	0.09	63	0.20	0.90	1230	UHW1J101MPD
	120	8 \times 15	0.09	75.6	0.20	0.90	1230	UHW1J121MPD
	120	10 \times 12.5	0.09	75.6	0.17	0.66	1280	UHW1J121MPD6
	150	8 \times 20	0.09	94.5	0.16	0.66	1580	UHW1J151MPD
	150	10 \times 12.5	0.09	94.5	0.17	0.66	1280	UHW1J151MPD6
	180	8 \times 20	0.09	113.4	0.16	0.66	1580	UHW1J181MPD6
180	10 \times 16	0.09	113.4	0.115	0.47	1200	UHW1J181MPD	

For cut leads, formed leads or taped parts, please add the appropriate code after the size code (12th digit).

If there is no size code in the part number, please add size code "1" and then add the appropriate code.

UHW

■Dimensions

Rated Voltage (V) (code)	Rated Capacitance (μ F)	Case Size ϕ D \times L (mm)	tan δ	Leakage Current (μ A) (at 20°C after 2 minutes)	Impedance (Ω) max.		Rated Ripple (mA _{rms}) (105°C/100kHz)	Part Number
					20°C/ 100kHz	-10°C/ 100kHz		
63 (1J)	270	10 \times 20	0.09	170.1	0.088	0.34	1570	UHW1J271MPD
	330	10 \times 25	0.09	207.9	0.072	0.28	1990	UHW1J331MPD
	390	10 \times 30.5	0.09	245.7	0.063	0.18	2050	UHW1J391MPD
	390	12.5 \times 20	0.09	245.7	0.065	0.18	1990	UHW1J391MHD6
	560	12.5 \times 25	0.09	352.8	0.049	0.14	2460	UHW1J561MHD
	680	12.5 \times 30.5	0.09	428.4	0.044	0.13	2760	UHW1J681MHD
	680	16 \times 20	0.09	428.4	0.050	0.15	2380	UHW1J681MHD6
	820	12.5 \times 35.5	0.09	516.6	0.038	0.11	3040	UHW1J821MHD
	820	18 \times 20	0.09	516.6	0.047	0.14	2460	UHW1J821MHD6
	1000	12.5 \times 40	0.09	630	0.033	0.095	3100	UHW1J102MHD
	1000	16 \times 25	0.09	630	0.040	0.12	2890	UHW1J102MHD6
	1200	16 \times 30.5	0.09	756	0.025	0.072	2930	UHW1J122MHD
	1200	18 \times 25	0.09	756	0.038	0.11	2930	UHW1J122MHD6
	1500	16 \times 35.5	0.09	945	0.023	0.066	3100	UHW1J152MHD
	1500	18 \times 30.5	0.09	945	0.024	0.069	3100	UHW1J152MHD6
	1800	16 \times 40	0.09	1134	0.021	0.060	3510	UHW1J182MHD
	1800	18 \times 35.5	0.09	1134	0.022	0.063	3510	UHW1J182MHD6
	2200	18 \times 40	0.11	1386	0.020	0.057	3860	UHW1J222MHD
80 (1K)	47	8 \times 11.5	0.09	37.6	0.29	1.30	950	UHW1K470MPD
	68	8 \times 15	0.09	54.4	0.20	0.90	1230	UHW1K680MPD
	82	10 \times 12.5	0.09	65.6	0.17	0.66	1280	UHW1K820MPD
	100	8 \times 20	0.09	80	0.16	0.66	1580	UHW1K101MPD
	120	10 \times 16	0.09	96	0.115	0.47	1040	UHW1K121MPD
	180	10 \times 20	0.09	144	0.088	0.34	1430	UHW1K181MPD
	180	12.5 \times 15	0.09	144	0.115	0.47	1430	UHW1K181MHD6
	220	10 \times 25	0.09	176	0.072	0.28	1620	UHW1K221MPD
	270	10 \times 30.5	0.09	216	0.063	0.18	1750	UHW1K271MPD
	270	12.5 \times 20	0.09	216	0.065	0.18	1750	UHW1K271MHD6
	390	12.5 \times 25	0.09	312	0.049	0.14	2210	UHW1K391MHD
	470	12.5 \times 30.5	0.09	376	0.044	0.13	2400	UHW1K471MHD
	470	16 \times 20	0.09	376	0.050	0.15	1950	UHW1K471MHD6
	560	12.5 \times 35.5	0.09	448	0.038	0.11	2600	UHW1K561MHD
	560	18 \times 20	0.09	448	0.047	0.14	2270	UHW1K561MHD6
	680	12.5 \times 40	0.09	544	0.033	0.095	2860	UHW1K681MHD
	680	16 \times 25	0.09	544	0.040	0.12	2430	UHW1K681MHD6
	820	16 \times 30.5	0.09	656	0.033	0.095	2640	UHW1K821MHD
	820	18 \times 25	0.09	656	0.038	0.11	2500	UHW1K821MHD6
	1000	16 \times 35.5	0.09	800	0.030	0.086	2860	UHW1K102MHD
	1200	16 \times 40	0.09	960	0.028	0.081	3510	UHW1K122MHD
1200	18 \times 30.5	0.09	960	0.031	0.090	2860	UHW1K122MHD6	
1500	18 \times 35.5	0.09	1200	0.028	0.081	3510	UHW1K152MHD	
1800	18 \times 40	0.09	1440	0.027	0.076	3860	UHW1K182MHD	

For cut leads, formed leads or taped parts, please add the appropriate code after the size code (12th digit).
If there is no size code in the part number, please add size code "1" and then add the appropriate code.

UHW

■ Dimensions

Rated Voltage (V) (code)	Rated Capacitance (μ F)	Case Size ϕ D \times L (mm)	tan δ	Leakage Current (μ A) (at 20°C after 2 minutes)	Impedance (Ω) max.		Rated Ripple (mArms) (105°C/100kHz)	Part Number
					20°C/ 100kHz	-10°C/ 100kHz		
100 (2A)	33	8 \times 11.5	0.08	33	0.29	1.30	950	UHW2A330MPD
	47	8 \times 15	0.08	47	0.20	0.90	1230	UHW2A470MPD
	56	10 \times 12.5	0.08	56	0.17	0.66	1280	UHW2A560MPD
	68	8 \times 20	0.08	68	0.16	0.66	1580	UHW2A680MPD
	82	10 \times 16	0.08	82	0.115	0.47	1040	UHW2A820MPD
	100	10 \times 20	0.08	100	0.088	0.34	1430	UHW2A101MPD
	100	12.5 \times 15	0.08	100	0.115	0.47	1430	UHW2A101MHD6
	120	10 \times 25	0.08	120	0.072	0.28	1620	UHW2A121MPD
	180	12.5 \times 20	0.08	180	0.065	0.18	1750	UHW2A181MHD
	220	12.5 \times 25	0.08	220	0.049	0.14	2210	UHW2A221MHD
	270	12.5 \times 30.5	0.08	270	0.044	0.13	2400	UHW2A271MHD
	270	16 \times 20	0.08	270	0.050	0.15	1950	UHW2A271MHD6
	390	12.5 \times 35.5	0.08	390	0.038	0.11	2600	UHW2A391MHD
	390	16 \times 25	0.08	390	0.040	0.12	2430	UHW2A391MHD6
	390	18 \times 20	0.08	390	0.047	0.14	2270	UHW2A391MHD3
	470	12.5 \times 40	0.08	470	0.033	0.095	2860	UHW2A471MHD
	470	18 \times 25	0.08	470	0.038	0.11	2500	UHW2A471MHD6
	560	16 \times 30.5	0.08	560	0.033	0.095	2640	UHW2A561MHD
	680	16 \times 35.5	0.08	680	0.030	0.086	2860	UHW2A681MHD
	680	18 \times 30.5	0.08	680	0.031	0.090	2860	UHW2A681MHD6
820	16 \times 40	0.08	820	0.028	0.081	3510	UHW2A821MHD	
820	18 \times 35.5	0.08	820	0.028	0.081	3510	UHW2A821MHD6	
1000	18 \times 40	0.08	1000	0.027	0.076	3860	UHW2A102MHD	

For cut leads, formed leads or taped parts, please add the appropriate code after the size code (12th digit).
If there is no size code in the part number, please add size code "1" and then add the appropriate code.

- For formed lead or taped product specifications and minimum order quantity, please refer to the Guidelines for Aluminum Electrolytic Capacitors.

ALUMINUM ELECTROLYTIC CAPACITORS

UPJ

Low Impedance, For Switching Power Supplies



- Low impedance and high reliability withstanding 5000 hours load life at +105°C (3000 hours for smaller case sizes as specified below).
- Capacitance ranges available based on the numerical values in E12 series under JIS.
- Ideally suited for use of switching power supplies.
- Compliant to the RoHS directive (2011/65/EU,(EU)2015/863).

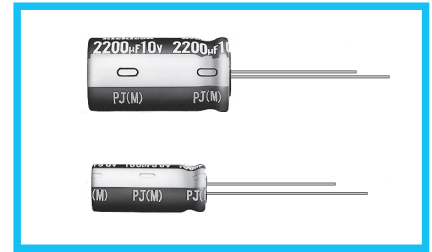
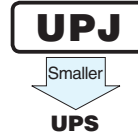

Specifications

Item	Performance Characteristics	
Category Temperature Range	-55 to +105°C	
Rated Voltage Range	6.3 to 100V	
Rated Capacitance Range	22 to 15000µF	
Capacitance Tolerance	±20% at 120Hz, 20°C	
Leakage Current ※	After 1 minute's application of rated voltage at 20°C, leakage current is not more than 0.03CV (µA).	
Tangent of loss angle (tan δ)	120Hz, 20°C	
	Rated Voltage (V)	6.3 10 16 25 35 50 63 to 100
	tan δ (max.)	0.22 0.19 0.16 0.14 0.12 0.10 0.08
	For capacitance of more than 1000µF, add 0.02 for every increase of 1000µF.	
Stability at Low Temperature	120Hz	
	Rated voltage (V)	6.3-10 16 25-35 50 to 100
	Impedance ratio (max.)	Z(-55°C) / Z(+20°C) 4 3 3 2
Endurance	The specifications listed below shall be met when the capacitors are restored to 20°C after D.C. bias plus rated ripple current is applied at 105°C for the condition listed at right. The peak voltage shall not exceed the rated voltage.	
	Rated Voltage	φD(mm) φ8 ≥φ10
	6.3~100V	3000hrs. 5000hrs.
	Capacitance change	Within ±20% of the initial capacitance value
	tan δ	200% or less than the initial specified value
	Leakage current	Less than or equal to the initial specified value
Shelf Life	After storing the capacitors under no load at 105°C for 1000 hours and then performing voltage treatment based on JIS C 5101-4 clause 4.1 at 20°C, they shall meet the specified values for the endurance characteristics listed at right.	
	Capacitance change	Within ±20% of the initial capacitance value
	tan δ	150% or less than the initial specified value
	Leakage current	Less than or equal to the initial specified value
Marking	Printed with white color letter on dark brown sleeve.	

※ I : Leakage Current (µA), C : Rated Capacitance (µF), V : Rated Voltage (V)

Radial Lead Type

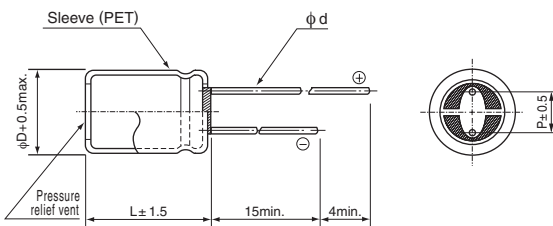

	(mm)				
φD	8	10	12.5	16	18
P	3.5	5.0	5.0	7.5	7.5
φd	0.6	0.6	0.6 [○]	0.8	0.8

※ In case L > 25 for the φ12.5 dia. unit, lead dia. φd = 0.8mm.

- Please refer to the Guidelines for Aluminum Electrolytic Capacitors for end seal configuration information.

Type numbering system (Example : 25V 470µF)

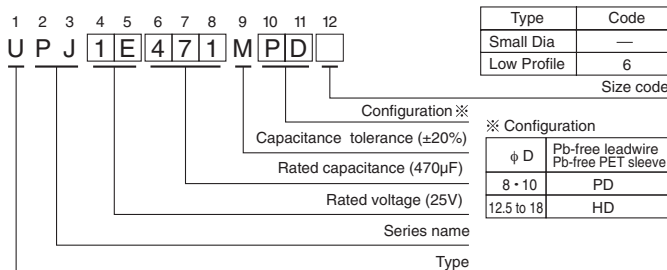

Frequency coefficient of rated ripple current

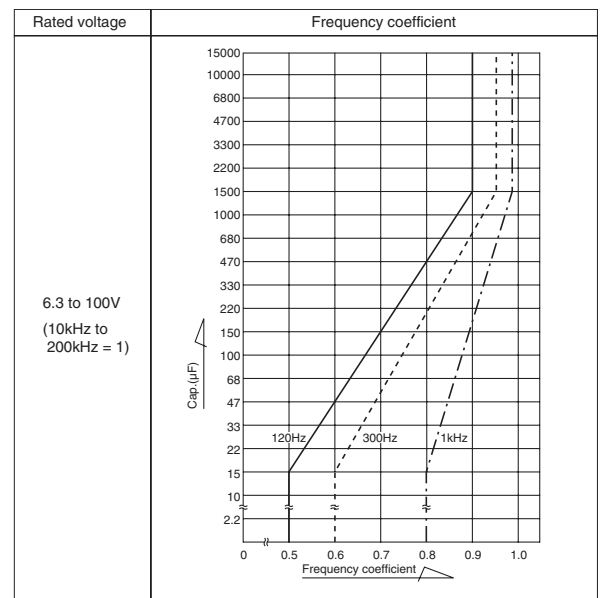

● Dimension table in next page.



■ Dimensions

Rated Voltage (V) (code)	Rated Capacitance (μF)	Case Size φD×L (mm)	tan δ	Leakage Current (μA) (at 20°C after 1 minute)	Impedance (Ω) max.		Rated Ripple (mA _{rms})		Part Number
					20°C/ 100kHz	-10°C/ 100kHz	105°C/ 10 to 200kHz	105°C/ 120Hz	
6.3 (0J)	390	8×11.5	0.22	73.71	0.27	0.68	445	345	UPJ0J391MPD
	470	8×15	0.22	88.83	0.22	0.55	550	435	UPJ0J471MPD
	470	10×12.5	0.22	88.83	0.23	0.58	575	455	UPJ0J471MPD6
	560	8×15	0.22	105.84	0.19	0.48	595	480	UPJ0J561MPD
	560	10×12.5	0.22	105.84	0.21	0.53	600	485	UPJ0J561MPD6
	680	8×20	0.22	128.52	0.16	0.40	730	605	UPJ0J681MPD
	680	10×16	0.22	128.52	0.18	0.45	700	580	UPJ0J681MPD6
	820	8×20	0.22	154.98	0.13	0.33	795	670	UPJ0J821MPD
	820	10×16	0.22	154.98	0.15	0.38	750	635	UPJ0J821MPD6
	1000	10×20	0.22	189	0.12	0.30	950	820	UPJ0J102MPD
	1000	12.5×15	0.22	189	0.13	0.33	890	765	UPJ0J102MHD6
	1200	10×20	0.22	226.8	0.10	0.25	1020	895	UPJ0J122MPD
	1200	12.5×15	0.22	226.8	0.12	0.30	950	835	UPJ0J122MHD6
	1500	10×25	0.22	283.5	0.084	0.21	1220	1090	UPJ0J152MPD
	1500	12.5×15	0.22	283.5	0.10	0.25	1020	915	UPJ0J152MHD6
	1800	10×30.5	0.22	340.2	0.078	0.20	1370	1230	UPJ0J182MPD
	1800	16×15	0.22	340.2	0.084	0.21	1270	1140	UPJ0J182MHD6
	2200	10×30.5	0.24	415.8	0.066	0.17	1470	1320	UPJ0J222MPD
	2200	16×15	0.24	415.8	0.078	0.20	1340	1200	UPJ0J222MHD6
	2700	12.5×25	0.24	510.3	0.051	0.14	1590	1430	UPJ0J272MHD
	2700	18×15	0.24	510.3	0.072	0.18	1500	1350	UPJ0J272MHD6
	3300	12.5×25	0.26	623.7	0.045	0.11	1710	1530	UPJ0J332MHD
	3300	18×15	0.26	623.7	0.065	0.16	1600	1440	UPJ0J332MHD6
	3900	12.5×30.5	0.26	737.1	0.037	0.093	1910	1710	UPJ0J392MHD
	3900	16×20	0.26	737.1	0.056	0.14	1720	1540	UPJ0J392MHD6
	4700	12.5×35.5	0.28	888.3	0.034	0.085	2100	1890	UPJ0J472MHD
	4700	18×20	0.28	888.3	0.050	0.13	1920	1720	UPJ0J472MHD6
	5600	12.5×40	0.30	1058.4	0.031	0.078	2270	2040	UPJ0J562MHD
	5600	18×20	0.30	1058.4	0.047	0.12	1980	1780	UPJ0J562MHD6
	6800	16×30.5	0.32	1285.2	0.029	0.073	2370	2130	UPJ0J682MHD
	6800	18×25	0.32	1285.2	0.039	0.098	2210	1980	UPJ0J682MHD6
	8200	16×35.5	0.36	1549.8	0.027	0.068	2550	2290	UPJ0J822MHD
8200	18×30.5	0.36	1549.8	0.031	0.078	2390	2150	UPJ0J822MHD6	
10000	16×40	0.40	1890	0.025	0.063	2750	2470	UPJ0J103MHD	
10000	18×30.5	0.40	1890	0.028	0.070	2490	2240	UPJ0J103MHD6	
12000	18×35.5	0.44	2268	0.023	0.058	2820	2530	UPJ0J123MHD	
15000	18×40	0.50	2835	0.022	0.055	2960	2660	UPJ0J153MHD	

For cut leads, formed leads or taped parts, please add the appropriate code after the size code (12th digit).
If there is no size code in the part number, please add size code "1" and then add the appropriate code.



■Dimensions

Rated Voltage (V) (code)	Rated Capacitance (μF)	Case Size φD×L (mm)	tan δ	Leakage Current (μA) (at 20°C after 1 minute)	Impedance (Ω) max.		Rated Ripple (mArms)		Part Number
					20°C/ 100kHz	-10°C/ 100kHz	105°C/ 10 to 200kHz	105°C/ 120Hz	
10 (1A)	330	8×11.5	0.19	99	0.26	0.65	460	350	UPJ1A331MPD
	390	8×15	0.19	117	0.22	0.55	550	430	UPJ1A391MPD
	390	10×12.5	0.19	117	0.24	0.60	555	430	UPJ1A391MPD6
	470	8×15	0.19	141	0.19	0.48	595	475	UPJ1A471MPD
	470	10×12.5	0.19	141	0.21	0.53	600	475	UPJ1A471MPD6
	560	8×20	0.19	168	0.16	0.40	730	590	UPJ1A561MPD
	560	10×16	0.19	168	0.18	0.45	700	565	UPJ1A561MPD6
	680	8×20	0.19	204	0.13	0.33	795	660	UPJ1A681MPD
	680	10×16	0.19	204	0.14	0.35	770	635	UPJ1A681MPD6
	820	10×20	0.19	246	0.11	0.28	985	835	UPJ1A821MPD
	820	12.5×15	0.19	246	0.13	0.33	920	780	UPJ1A821MHD6
	1000	10×20	0.19	300	0.096	0.24	1060	915	UPJ1A102MPD
	1000	12.5×15	0.19	300	0.10	0.25	1040	895	UPJ1A102MHD6
	1200	10×25	0.19	360	0.078	0.20	1280	1120	UPJ1A122MPD
	1200	12.5×15	0.19	360	0.096	0.24	1060	930	UPJ1A122MHD6
	1500	10×30.5	0.19	450	0.072	0.18	1440	1290	UPJ1A152MPD
	1500	16×15	0.19	450	0.078	0.20	1330	1190	UPJ1A152MHD6
	1800	12.5×20	0.19	540	0.057	0.14	1470	1320	UPJ1A182MHD
	1800	16×15	0.19	540	0.072	0.18	1420	1270	UPJ1A182MHD6
	2200	12.5×25	0.21	660	0.045	0.11	1710	1530	UPJ1A222MHD
	2200	18×15	0.21	660	0.060	0.15	1600	1440	UPJ1A222MHD6
	2700	12.5×30.5	0.21	810	0.036	0.09	1940	1740	UPJ1A272MHD
	2700	16×20	0.21	810	0.051	0.13	1740	1560	UPJ1A272MHD6
	3300	12.5×35.5	0.23	990	0.032	0.08	2180	1960	UPJ1A332MHD
	3300	16×20	0.23	990	0.045	0.11	1850	1660	UPJ1A332MHD6
	3900	12.5×40	0.23	1170	0.030	0.075	2360	2120	UPJ1A392MHD
	3900	18×20	0.23	1170	0.041	0.10	2050	1840	UPJ1A392MHD6
	4700	16×30.5	0.25	1410	0.028	0.070	2420	2170	UPJ1A472MHD
	4700	18×25	0.25	1410	0.035	0.088	2250	2020	UPJ1A472MHD6
	5600	16×35.5	0.27	1680	0.026	0.065	2610	2340	UPJ1A562MHD
	5600	18×25	0.27	1680	0.033	0.083	2340	2100	UPJ1A562MHD6
	6800	16×35.5	0.29	2040	0.024	0.060	2680	2410	UPJ1A682MHD
	6800	18×30.5	0.29	2040	0.027	0.068	2540	2280	UPJ1A682MHD6
8200	16×40	0.33	2460	0.023	0.058	2820	2530	UPJ1A822MHD	
8200	18×35.5	0.33	2460	0.025	0.063	2690	2420	UPJ1A822MHD6	
10000	18×40	0.37	3000	0.021	0.053	3040	2730	UPJ1A103MHD	

For cut leads, formed leads or taped parts, please add the appropriate code after the size code (12th digit).
If there is no size code in the part number, please add size code "1" and then add the appropriate code.

UPJ

■ Dimensions

Rated Voltage (V) (code)	Rated Capacitance (μF)	Case Size φD×L (mm)	tan δ	Leakage Current (μA) (at 20°C after 1 minute)	Impedance (Ω) max.		Rated Ripple (mArms)		Part Number
					20°C/ 100kHz	-10°C/ 100kHz	105°C/ 10 to 200kHz	105°C/ 120Hz	
16 (1C)	220	8×11.5	0.16	105.6	0.26	0.65	460	335	UPJ1C221MPD
	270	8×15	0.16	129.6	0.22	0.55	550	410	UPJ1C271MPD
	270	10×12.5	0.16	129.6	0.22	0.55	575	430	UPJ1C271MPD6
	330	8×15	0.16	158.4	0.18	0.45	595	455	UPJ1C331MPD
	330	10×12.5	0.16	158.4	0.18	0.45	625	480	UPJ1C331MPD6
	390	8×20	0.16	187.2	0.16	0.40	730	570	UPJ1C391MPD
	390	10×16	0.16	187.2	0.16	0.40	730	570	UPJ1C391MPD6
	470	8×20	0.16	225.6	0.14	0.35	770	615	UPJ1C471MPD
	470	10×16	0.16	225.6	0.14	0.35	770	615	UPJ1C471MPD6
	560	10×20	0.16	268.8	0.12	0.30	950	770	UPJ1C561MPD
	560	12.5×15	0.16	268.8	0.13	0.33	920	745	UPJ1C561MHD6
	680	10×20	0.16	326.4	0.10	0.25	1020	845	UPJ1C681MPD
	680	12.5×15	0.16	326.4	0.11	0.28	985	815	UPJ1C681MHD6
	820	10×25	0.16	393.6	0.084	0.21	1220	1030	UPJ1C821MPD
	820	12.5×15	0.16	393.6	0.096	0.24	1060	895	UPJ1C821MHD6
	1000	10×30.5	0.16	480	0.072	0.18	1410	1210	UPJ1C102MPD
	1000	16×15	0.16	480	0.084	0.21	1270	1090	UPJ1C102MHD6
	1200	12.5×20	0.16	576	0.060	0.15	1430	1250	UPJ1C122MHD
	1200	16×15	0.16	576	0.072	0.18	1390	1220	UPJ1C122MHD6
	1500	12.5×25	0.16	720	0.048	0.12	1660	1490	UPJ1C152MHD
	1500	18×15	0.16	720	0.066	0.17	1560	1400	UPJ1C152MHD6
	1800	12.5×30.5	0.16	864	0.039	0.10	1880	1690	UPJ1C182MHD
	1800	16×20	0.16	864	0.054	0.14	1700	1530	UPJ1C182MHD6
	2200	12.5×30.5	0.18	1056	0.034	0.085	2010	1800	UPJ1C222MHD
	2200	16×20	0.18	1056	0.048	0.12	1800	1620	UPJ1C222MHD6
	2700	12.5×35.5	0.18	1296	0.031	0.078	2220	1990	UPJ1C272MHD
	2700	16×25	0.18	1296	0.040	0.10	2010	1800	UPJ1C272MHD6
	3300	12.5×40	0.20	1584	0.028	0.07	2410	2160	UPJ1C332MHD
	3300	18×20	0.20	1584	0.039	0.10	2090	1880	UPJ1C332MHD6
	3900	16×30.5	0.20	1872	0.027	0.068	2470	2220	UPJ1C392MHD
	3900	18×25	0.20	1872	0.034	0.085	2290	2060	UPJ1C392MHD6
	4700	16×35.5	0.22	2256	0.025	0.063	2680	2410	UPJ1C472MHD
4700	18×30.5	0.22	2256	0.028	0.070	2490	2240	UPJ1C472MHD6	
5600	16×40	0.24	2688	0.024	0.060	2820	2530	UPJ1C562MHD	
5600	18×35.5	0.24	2688	0.027	0.068	2620	2350	UPJ1C562MHD6	
6800	18×35.5	0.26	3264	0.022	0.055	2900	2610	UPJ1C682MHD	
8200	18×40	0.30	3936	0.021	0.053	3040	2730	UPJ1C822MHD	

For cut leads, formed leads or taped parts, please add the appropriate code after the size code (12th digit).
If there is no size code in the part number, please add size code "1" and then add the appropriate code.

UPJ

■ Dimensions

Rated Voltage (V) (code)	Rated Capacitance (μF)	Case Size φD×L (mm)	tan δ	Leakage Current (μA) (at 20°C after 1 minute)	Impedance (Ω) max.		Rated Ripple (mArms)		Part Number
					20°C/ 100kHz	-10°C/ 100kHz	105°C/ 10 to 200kHz	105°C/ 120Hz	
25 (1E)	150	8×11.5	0.14	112.5	0.26	0.65	460	320	UPJ1E151MPD
	180	8×15	0.14	135	0.22	0.55	550	390	UPJ1E181MPD
	180	10×12.5	0.14	135	0.24	0.60	555	395	UPJ1E181MPD6
	220	8×15	0.14	165	0.18	0.45	625	455	UPJ1E221MPD
	220	10×12.5	0.14	165	0.21	0.53	600	435	UPJ1E221MPD6
	270	8×20	0.14	202.5	0.15	0.38	750	560	UPJ1E271MPD
	270	10×16	0.14	202.5	0.18	0.45	700	525	UPJ1E271MPD6
	330	8×20	0.14	247.5	0.13	0.33	795	610	UPJ1E331MPD
	330	10×16	0.14	247.5	0.15	0.38	750	575	UPJ1E331MPD6
	390	10×20	0.14	292.5	0.11	0.28	985	770	UPJ1E391MPD
	390	12.5×15	0.14	292.5	0.13	0.33	920	720	UPJ1E391MHD6
	470	10×20	0.14	352.5	0.10	0.25	1020	810	UPJ1E471MPD
	470	12.5×15	0.14	352.5	0.11	0.28	985	785	UPJ1E471MHD6
	560	10×25	0.14	420	0.084	0.21	1220	990	UPJ1E561MPD
	560	12.5×15	0.14	420	0.10	0.25	1060	860	UPJ1E561MHD6
	680	10×30.5	0.14	510	0.072	0.18	1420	1180	UPJ1E681MPD
	680	16×15	0.14	510	0.084	0.21	1270	1050	UPJ1E681MHD6
	820	12.5×20	0.14	615	0.059	0.15	1430	1210	UPJ1E821MHD
	820	16×15	0.14	615	0.079	0.20	1340	1130	UPJ1E821MHD6
	1000	12.5×25	0.14	750	0.048	0.12	1660	1430	UPJ1E102MHD
	1000	18×15	0.14	750	0.066	0.17	1520	1310	UPJ1E102MHD6
	1200	12.5×25	0.14	900	0.043	0.11	1760	1550	UPJ1E122MHD
	1200	18×15	0.14	900	0.061	0.15	1600	1400	UPJ1E122MHD6
	1500	12.5×30.5	0.14	1125	0.035	0.088	1980	1780	UPJ1E152MHD
	1500	16×20	0.14	1125	0.050	0.13	1770	1590	UPJ1E152MHD6
	1800	12.5×35.5	0.14	1350	0.032	0.08	2180	1960	UPJ1E182MHD
	1800	16×25	0.14	1350	0.041	0.10	1980	1780	UPJ1E182MHD6
	2200	12.5×40	0.16	1650	0.029	0.073	2360	2120	UPJ1E222MHD
	2200	18×20	0.16	1650	0.040	0.10	2050	1840	UPJ1E222MHD6
	2700	16×30.5	0.16	2025	0.027	0.068	2470	2220	UPJ1E272MHD
	2700	18×25	0.16	2025	0.034	0.085	2290	2060	UPJ1E272MHD6
	3300	16×35.5	0.18	2475	0.025	0.063	2680	2410	UPJ1E332MHD
	3300	18×30.5	0.18	2475	0.029	0.073	2490	2240	UPJ1E332MHD6
3900	16×40	0.18	2925	0.023	0.058	2820	2530	UPJ1E392MHD	
3900	18×35.5	0.18	2925	0.026	0.065	2690	2420	UPJ1E392MHD6	
4700	18×40	0.20	3525	0.022	0.055	2960	2660	UPJ1E472MHD	

For cut leads, formed leads or taped parts, please add the appropriate code after the size code (12th digit).
If there is no size code in the part number, please add size code "1" and then add the appropriate code.



■ Dimensions

Rated Voltage (V) (code)	Rated Capacitance (μF)	Case Size φD×L (mm)	tan δ	Leakage Current (μA) (at 20°C after 1 minute)	Impedance (Ω) max.		Rated Ripple (mArms)		Part Number
					20°C/ 100kHz	-10°C/ 100kHz	105°C/ 10 to 200kHz	105°C/ 120Hz	
35 (1V)	100	8×11.5	0.12	105	0.26	0.65	460	305	UPJ1V101MPD
	120	8×15	0.12	126	0.22	0.55	550	370	UPJ1V121MPD
	120	10×12.5	0.12	126	0.24	0.60	555	375	UPJ1V121MPD6
	150	8×15	0.12	157.5	0.18	0.45	595	415	UPJ1V151MPD
	150	10×12.5	0.12	157.5	0.20	0.50	625	435	UPJ1V151MPD6
	180	8×20	0.12	189	0.16	0.40	730	520	UPJ1V181MPD
	180	10×16	0.12	189	0.18	0.45	700	500	UPJ1V181MPD6
	220	8×20	0.12	231	0.13	0.33	795	580	UPJ1V221MPD
	220	10×16	0.12	231	0.14	0.35	770	560	UPJ1V221MPD6
	270	10×20	0.12	283.5	0.11	0.28	985	735	UPJ1V271MPD
	270	12.5×15	0.12	283.5	0.13	0.33	920	690	UPJ1V271MHD6
	330	10×20	0.12	346.5	0.096	0.24	1060	810	UPJ1V331MPD
	330	12.5×15	0.12	346.5	0.10	0.25	1020	780	UPJ1V331MHD6
	390	10×25	0.12	409.5	0.084	0.21	1220	955	UPJ1V391MPD
	390	12.5×15	0.12	409.5	0.096	0.24	1060	825	UPJ1V391MHD6
	470	10×30.5	0.12	493.5	0.072	0.18	1420	1130	UPJ1V471MPD
	470	16×15	0.12	493.5	0.084	0.21	1270	1010	UPJ1V471MHD6
	560	12.5×20	0.12	588	0.059	0.15	1430	1160	UPJ1V561MHD
	560	16×15	0.12	588	0.075	0.19	1360	1100	UPJ1V561MHD6
	680	12.5×25	0.12	714	0.048	0.12	1660	1370	UPJ1V681MHD
	680	18×15	0.12	714	0.066	0.17	1540	1270	UPJ1V681MHD6
	820	12.5×25	0.12	861	0.042	0.11	1760	1490	UPJ1V821MHD
	820	18×15	0.12	861	0.060	0.15	1620	1370	UPJ1V821MHD6
	1000	12.5×30.5	0.12	1050	0.035	0.088	1980	1710	UPJ1V102MHD
	1000	16×20	0.12	1050	0.050	0.13	1770	1530	UPJ1V102MHD6
	1200	12.5×35.5	0.12	1260	0.031	0.078	2180	1920	UPJ1V122MHD
	1200	16×25	0.12	1260	0.041	0.10	1980	1740	UPJ1V122MHD6
	1500	12.5×40	0.12	1575	0.029	0.073	2360	2120	UPJ1V152MHD
	1500	18×20	0.12	1575	0.040	0.10	2050	1840	UPJ1V152MHD6
	1800	16×30.5	0.12	1890	0.027	0.068	2470	2220	UPJ1V182MHD
	1800	18×25	0.12	1890	0.034	0.085	2290	2060	UPJ1V182MHD6
	2200	16×35.5	0.14	2310	0.024	0.060	2680	2410	UPJ1V222MHD
	2200	18×30.5	0.14	2310	0.028	0.070	2490	2240	UPJ1V222MHD6
2700	16×40	0.14	2835	0.022	0.055	2900	2610	UPJ1V272MHD	
2700	18×35.5	0.14	2835	0.026	0.065	2690	2420	UPJ1V272MHD6	
3300	18×40	0.16	3465	0.021	0.053	3040	2730	UPJ1V332MHD	

For cut leads, formed leads or taped parts, please add the appropriate code after the size code (12th digit).
If there is no size code in the part number, please add size code "1" and then add the appropriate code.

UPJ

■ Dimensions

Rated Voltage (V) (code)	Rated Capacitance (μ F)	Case Size ϕ D \times L (mm)	tan δ	Leakage Current (μ A) (at 20°C after 1 minute)	Impedance (Ω) max.		Rated Ripple (mA _{rms})		Part Number
					20°C/ 100kHz	-10°C/ 100kHz	105°C/ 10 to 200kHz	105°C/ 120Hz	
50 (1H)	68	8 \times 11.5	0.10	102	0.28	0.70	410	255	UPJ1H680MPD
	82	8 \times 15	0.10	123	0.22	0.55	500	320	UPJ1H820MPD
	82	10 \times 12.5	0.10	123	0.23	0.58	510	330	UPJ1H820MPD6
	100	8 \times 20	0.10	150	0.18	0.45	620	410	UPJ1H101MPD
	100	10 \times 16	0.10	150	0.21	0.53	580	385	UPJ1H101MPD6
	120	8 \times 20	0.10	180	0.16	0.40	670	455	UPJ1H121MPD
	120	10 \times 16	0.10	180	0.17	0.43	640	435	UPJ1H121MPD6
	150	10 \times 20	0.10	225	0.13	0.33	820	570	UPJ1H151MPD
	150	12.5 \times 15	0.10	225	0.14	0.35	785	545	UPJ1H151MHD6
	180	10 \times 20	0.10	270	0.11	0.28	890	635	UPJ1H181MPD
	180	12.5 \times 15	0.10	270	0.12	0.31	845	605	UPJ1H181MHD6
	220	10 \times 25	0.10	330	0.098	0.25	1040	760	UPJ1H221MPD
	220	12.5 \times 15	0.10	330	0.10	0.25	920	670	UPJ1H221MHD6
	270	10 \times 30.5	0.10	405	0.085	0.21	1200	900	UPJ1H271MPD
	270	16 \times 15	0.10	405	0.091	0.23	1120	840	UPJ1H271MHD6
	330	10 \times 30.5	0.10	495	0.072	0.18	1300	995	UPJ1H331MPD
	330	16 \times 15	0.10	495	0.078	0.20	1210	925	UPJ1H331MHD6
	390	12.5 \times 25	0.10	585	0.053	0.13	1440	1120	UPJ1H391MHD
	390	16 \times 15	0.10	585	0.072	0.18	1270	990	UPJ1H391MHD6
	470	12.5 \times 25	0.10	705	0.048	0.12	1500	1190	UPJ1H471MHD
	470	18 \times 15	0.10	705	0.060	0.15	1470	1170	UPJ1H471MHD6
	560	12.5 \times 30.5	0.10	840	0.040	0.10	1680	1360	UPJ1H561MHD
	560	16 \times 20	0.10	840	0.053	0.13	1550	1260	UPJ1H561MHD6
	680	12.5 \times 35.5	0.10	1020	0.036	0.09	1850	1530	UPJ1H681MHD
	680	16 \times 20	0.10	1020	0.048	0.12	1630	1350	UPJ1H681MHD6
	820	12.5 \times 40	0.10	1230	0.033	0.083	2010	1700	UPJ1H821MHD
	820	18 \times 20	0.10	1230	0.043	0.11	1810	1530	UPJ1H821MHD6
	1000	16 \times 30.5	0.10	1500	0.030	0.075	2120	1830	UPJ1H102MHD
	1000	18 \times 25	0.10	1500	0.036	0.090	2000	1730	UPJ1H102MHD6
	1200	16 \times 35.5	0.10	1800	0.028	0.070	2260	1990	UPJ1H122MHD
1200	18 \times 30.5	0.10	1800	0.031	0.078	2140	1880	UPJ1H122MHD6	
1500	16 \times 40	0.10	2250	0.026	0.065	2410	2170	UPJ1H152MHD	
1500	18 \times 30.5	0.10	2250	0.029	0.073	2220	1990	UPJ1H152MHD6	
1800	18 \times 35.5	0.10	2700	0.025	0.063	2460	2210	UPJ1H182MHD	
2200	18 \times 40	0.12	3300	0.024	0.060	2560	2300	UPJ1H222MHD	

For cut leads, formed leads or taped parts, please add the appropriate code after the size code (12th digit).
If there is no size code in the part number, please add size code "1" and then add the appropriate code.

UPJ

■ Dimensions

Rated Voltage (V) (code)	Rated Capacitance (μF)	Case Size $\phi\text{D}\times\text{L}$ (mm)	$\tan \delta$	Leakage Current (μA) (at 20°C after 1 minute)	Impedance (Ω) max.		Rated Ripple (mArms)		Part Number
					20°C/ 100kHz	-10°C/ 100kHz	105°C/ 10 to 200kHz	105°C/ 120Hz	
63 (1J)	47	8×11.5	0.08	88.83	0.37	0.93	365	215	UPJ1J470MPD
	56	8×15	0.08	105.84	0.31	0.78	450	275	UPJ1J560MPD
	56	10×12.5	0.08	105.84	0.34	0.85	450	275	UPJ1J560MPD6
	68	8×15	0.08	128.52	0.26	0.65	500	315	UPJ1J680MPD
	68	10×12.5	0.08	128.52	0.28	0.70	495	310	UPJ1J680MPD6
	82	8×20	0.08	154.98	0.22	0.55	600	385	UPJ1J820MPD
	82	10×16	0.08	154.98	0.24	0.60	580	375	UPJ1J820MPD6
	100	10×20	0.08	189	0.18	0.45	750	495	UPJ1J101MPD
	100	12.5×15	0.08	189	0.20	0.50	695	460	UPJ1J101MHD6
	120	10×20	0.08	226.8	0.15	0.38	820	555	UPJ1J121MPD
	120	12.5×15	0.08	226.8	0.18	0.45	750	510	UPJ1J121MHD6
	150	10×25	0.08	283.5	0.13	0.33	950	665	UPJ1J151MPD
	150	12.5×15	0.08	283.5	0.14	0.35	845	590	UPJ1J151MHD6
	180	10×30.5	0.08	340.2	0.11	0.28	1110	790	UPJ1J181MPD
	180	16×15	0.08	340.2	0.12	0.30	1050	750	UPJ1J181MHD6
	220	12.5×20	0.08	415.8	0.094	0.24	1140	835	UPJ1J221MHD
	220	16×15	0.08	415.8	0.10	0.25	1120	820	UPJ1J221MHD6
	270	12.5×25	0.08	510.3	0.081	0.20	1340	1000	UPJ1J271MHD
	270	18×15	0.08	510.3	0.088	0.22	1290	965	UPJ1J271MHD6
	330	12.5×25	0.08	623.7	0.072	0.18	1420	1090	UPJ1J331MHD
	330	18×15	0.08	623.7	0.078	0.20	1410	1080	UPJ1J331MHD6
	390	12.5×30.5	0.08	737.1	0.059	0.15	1620	1260	UPJ1J391MHD
	390	16×20	0.08	737.1	0.070	0.18	1500	1170	UPJ1J391MHD6
	470	12.5×35.5	0.08	888.3	0.052	0.13	1780	1420	UPJ1J471MHD
	470	16×25	0.08	888.3	0.063	0.16	1700	1350	UPJ1J471MHD6
	560	12.5×40	0.08	1058.4	0.047	0.12	1950	1580	UPJ1J561MHD
	560	18×20	0.08	1058.4	0.058	0.15	1730	1400	UPJ1J561MHD6
	680	16×30.5	0.08	1285.2	0.043	0.11	2050	1700	UPJ1J681MHD
	680	18×25	0.08	1285.2	0.051	0.13	1940	1610	UPJ1J681MHD6
	820	16×35.5	0.08	1549.8	0.040	0.10	2220	1880	UPJ1J821MHD
820	18×30.5	0.08	1549.8	0.043	0.12	2110	1780	UPJ1J821MHD6	
1000	16×40	0.08	1890	0.037	0.093	2370	2050	UPJ1J102MHD	
1000	18×35.5	0.08	1890	0.040	0.10	2280	1970	UPJ1J102MHD6	
1200	18×40	0.08	2268	0.034	0.085	2510	2210	UPJ1J122MHD	

For cut leads, formed leads or taped parts, please add the appropriate code after the size code (12th digit).
If there is no size code in the part number, please add size code "1" and then add the appropriate code.



■ Dimensions

Rated Voltage (V) (code)	Rated Capacitance (μF)	Case Size φD×L (mm)	tan δ	Leakage Current (μA) (at 20°C after 1 minute)	Impedance (Ω) max.		Rated Ripple (mA _{rms})		Part Number
					20°C/ 100kHz	-10°C/ 100kHz	105°C/ 10 to 200kHz	105°C/ 120Hz	
80 (1K)	33	8×11.5	0.08	79.2	0.53	1.40	234	132	UPJ1K330MPD
	39	8×15	0.08	93.6	0.46	1.20	272	156	UPJ1K390MPD
	39	10×12.5	0.08	93.6	0.49	1.30	271	155	UPJ1K390MPD6
	47	8×15	0.08	112.8	0.39	1.10	295	175	UPJ1K470MPD
	47	10×12.5	0.08	112.8	0.42	1.10	293	174	UPJ1K470MPD6
	56	8×20	0.08	134.4	0.34	0.92	347	208	UPJ1K560MPD
	56	10×16	0.08	134.4	0.36	0.97	337	202	UPJ1K560MPD6
	68	10×20	0.08	163.2	0.28	0.76	426	264	UPJ1K680MPD
	68	12.5×15	0.08	163.2	0.31	0.84	402	249	UPJ1K680MHD6
	82	10×20	0.08	196.8	0.25	0.68	447	284	UPJ1K820MPD
	82	12.5×15	0.08	196.8	0.27	0.73	430	273	UPJ1K820MHD6
	100	10×25	0.08	240	0.21	0.57	526	347	UPJ1K101MPD
	100	12.5×15	0.08	240	0.23	0.62	466	308	UPJ1K101MHD6
	120	10×30.5	0.08	288	0.18	0.49	606	406	UPJ1K121MPD
	120	16×15	0.08	288	0.20	0.54	663	444	UPJ1K121MHD6
	150	10×30.5	0.08	360	0.15	0.41	663	459	UPJ1K151MPD
	150	16×15	0.08	360	0.18	0.47	699	484	UPJ1K151MHD6
	180	12.5×25	0.08	432	0.13	0.35	734	520	UPJ1K181MHD
	180	16×15	0.08	432	0.15	0.41	766	543	UPJ1K181MHD6
	220	12.5×30.5	0.08	528	0.12	0.32	816	595	UPJ1K221MHD
	220	18×15	0.08	528	0.13	0.35	881	643	UPJ1K221MHD6
	270	12.5×30.5	0.08	648	0.10	0.27	894	667	UPJ1K271MHD
	270	16×20	0.08	648	0.11	0.30	995	742	UPJ1K271MHD6
	330	12.5×35.5	0.08	792	0.088	0.24	1000	767	UPJ1K331MHD
	330	16×25	0.08	792	0.099	0.27	1140	874	UPJ1K331MHD6
	390	12.5×40	0.08	936	0.078	0.21	1060	822	UPJ1K391MHD
	390	18×20	0.08	936	0.089	0.24	1170	908	UPJ1K391MHD6
	470	16×30.5	0.08	1128	0.069	0.19	1450	1150	UPJ1K471MHD
	470	18×25	0.08	1128	0.080	0.22	1330	1060	UPJ1K471MHD6
	560	16×35.5	0.08	1344	0.062	0.17	1600	1300	UPJ1K561MHD
560	18×30.5	0.08	1344	0.072	0.19	1490	1210	UPJ1K561MHD6	
680	16×40	0.08	1632	0.055	0.15	1770	1470	UPJ1K681MHD	
680	18×30.5	0.08	1632	0.065	0.18	1560	1300	UPJ1K681MHD6	
820	18×35.5	0.08	1968	0.049	0.13	1890	1590	UPJ1K821MHD	
1000	18×40	0.08	2400	0.044	0.12	2080	1790	UPJ1K102MHD	

For cut leads, formed leads or taped parts, please add the appropriate code after the size code (12th digit).
If there is no size code in the part number, please add size code "1" and then add the appropriate code.



■ Dimensions

Rated Voltage (V) (code)	Rated Capacitance (μF)	Case Size φD×L (mm)	tan δ	Leakage Current (μA) (at 20°C after 1 minute)	Impedance (Ω) max.		Rated Ripple (mA _{rms})		Part Number
					20°C/ 100kHz	-10°C/ 100kHz	105°C/ 10 to 200kHz	105°C/ 120Hz	
100 (2A)	22	8×11.5	0.08	66	0.55	1.50	230	122	UPJ2A220MPD
	27	8×15	0.08	81	0.47	1.30	269	146	UPJ2A270MPD
	27	10×12.5	0.08	81	0.50	1.40	268	145	UPJ2A270MPD6
	33	8×15	0.08	99	0.38	1.00	299	169	UPJ2A330MPD
	33	10×12.5	0.08	99	0.42	1.10	293	166	UPJ2A330MPD6
	39	8×20	0.08	117	0.33	0.89	352	202	UPJ2A390MPD
	39	10×16	0.08	117	0.36	0.97	337	193	UPJ2A390MPD6
	47	10×20	0.08	141	0.28	0.76	423	252	UPJ2A470MPD
	47	12.5×15	0.08	141	0.31	0.84	402	239	UPJ2A470MHD6
	56	10×20	0.08	168	0.24	0.65	456	274	UPJ2A560MPD
	56	12.5×15	0.08	168	0.27	0.73	430	258	UPJ2A560MHD6
	68	10×25	0.08	204	0.21	0.57	526	326	UPJ2A680MPD
	68	12.5×15	0.08	204	0.23	0.62	466	289	UPJ2A680MHD6
	82	10×30.5	0.08	246	0.18	0.49	606	386	UPJ2A820MPD
	82	16×15	0.08	246	0.19	0.51	681	433	UPJ2A820MHD6
	100	10×30.5	0.08	300	0.15	0.41	663	438	UPJ2A101MPD
	100	16×15	0.08	300	0.17	0.46	719	475	UPJ2A101MHD6
	120	12.5×25	0.08	360	0.13	0.35	774	519	UPJ2A121MHD
	120	16×15	0.08	360	0.14	0.38	793	531	UPJ2A121MHD6
	150	12.5×25	0.08	450	0.11	0.30	798	553	UPJ2A151MHD
	150	18×15	0.08	450	0.12	0.32	917	635	UPJ2A151MHD6
	180	12.5×30.5	0.08	540	0.098	0.26	904	641	UPJ2A181MHD
	180	16×20	0.08	540	0.11	0.30	995	706	UPJ2A181MHD6
	220	12.5×35.5	0.08	660	0.087	0.23	1000	730	UPJ2A221MHD
	220	16×25	0.08	660	0.093	0.25	1170	854	UPJ2A221MHD6
	270	12.5×40	0.08	810	0.072	0.19	1130	843	UPJ2A271MHD
	270	18×20	0.08	810	0.080	0.22	1230	918	UPJ2A271MHD6
	330	16×30.5	0.08	990	0.062	0.17	1520	1160	UPJ2A331MHD
	330	18×25	0.08	990	0.070	0.19	1420	1080	UPJ2A331MHD6
	390	16×35.5	0.08	1170	0.053	0.14	1730	1340	UPJ2A391MHD
	390	18×30.5	0.08	1170	0.062	0.17	1600	1240	UPJ2A391MHD6
	470	16×40	0.08	1410	0.047	0.13	1920	1530	UPJ2A471MHD
470	18×35.5	0.08	1410	0.056	0.15	1770	1410	UPJ2A471MHD6	
560	18×35.5	0.08	1680	0.041	0.11	2070	1680	UPJ2A561MHD	
680	18×40	0.08	2040	0.036	0.097	2300	1910	UPJ2A681MHD	

For cut leads, formed leads or taped parts, please add the appropriate code after the size code (12th digit).
If there is no size code in the part number, please add size code "1" and then add the appropriate code.

• For formed lead or taped product specifications and minimum order quantity, please refer to the Guidelines for Aluminum Electrolytic Capacitors.

ALUMINUM ELECTROLYTIC CAPACITORS

UPS

Miniature Sized, Low Impedance,
For Switching Power Supplies



- Wide temperature range type, miniature sized.
- Compliant to the RoHS directive (2011/65/EU,(EU)2015/863).

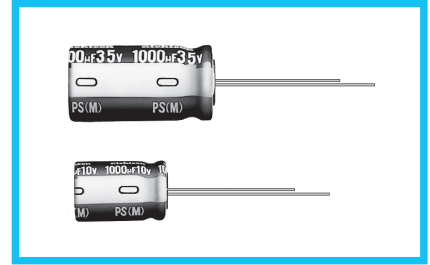

Specifications

Item	Performance Characteristics																		
Category Temperature Range	-55 to +105°C																		
Rated Voltage Range	6.3 to 100V																		
Rated Capacitance Range	22 to 15000µF																		
Capacitance Tolerance	±20% at 120Hz, 20°C																		
Leakage Current ※	After 1 minute's application of rated voltage at 20°C, leakage current is not more than 0.03CV (µA).																		
Tangent of loss angle (tan δ)	For capacitance of more than 1000µF, add 0.02 for every increase of 1000µF																		
	<table border="1"> <tr> <td>Rated voltage (V)</td> <td>6.3</td> <td>10</td> <td>16</td> <td>25</td> <td>35</td> <td>50</td> <td>63</td> <td>100</td> <td rowspan="2">Measurement frequency : 120Hz at 20°C</td> </tr> <tr> <td>tan δ (max.)</td> <td>0.24</td> <td>0.20</td> <td>0.16</td> <td>0.14</td> <td>0.12</td> <td>0.10</td> <td>0.09</td> <td>0.08</td> </tr> </table>	Rated voltage (V)	6.3	10	16	25	35	50	63	100	Measurement frequency : 120Hz at 20°C	tan δ (max.)	0.24	0.20	0.16	0.14	0.12	0.10	0.09
Rated voltage (V)	6.3	10	16	25	35	50	63	100	Measurement frequency : 120Hz at 20°C										
tan δ (max.)	0.24	0.20	0.16	0.14	0.12	0.10	0.09	0.08											
Stability at Low Temperature	Measurement frequency : 120Hz																		
	Rated voltage (V)	6.3 · 10	16 · 25	35 · 50	63 · 100														
	Impedance ratio (max.)	Z(-25°C) / Z(+20°C)	—	—	—	2													
Endurance	The specifications listed at right shall be met when the capacitors are restored to 20°C after D.C. bias plus rated ripple current is applied for 3000 hours (2000 hours for φD= 8 to 10) at 105°C, the peak voltage shall not exceed the rated voltage.	Capacitance change	Within ±20% of the initial capacitance value																
		tan δ	200% or less than the initial specified value																
		Leakage current	Less than or equal to the initial specified value																
Shelf Life	After storing the capacitors under no load at 105°C for 1000 hours and then performing voltage treatment based on JIS C 5101-4 clause 4.1 at 20°C, they shall meet the specified values for the endurance characteristics listed above.																		
Marking	Printed with white color letter on dark brown sleeve.																		

※ I : Leakage Current (µA), C : Rated Capacitance (µF), V : Rated Voltage (V)

Radial Lead Type

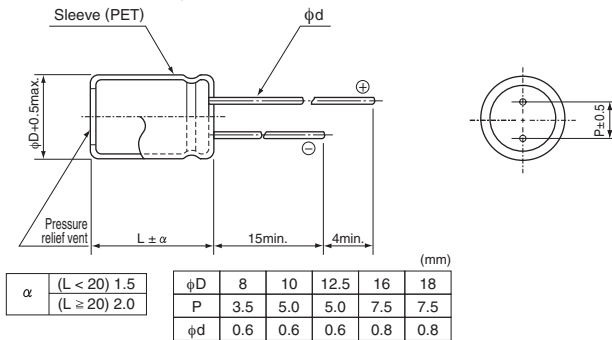

Type numbering system (Example : 25V 470µF)

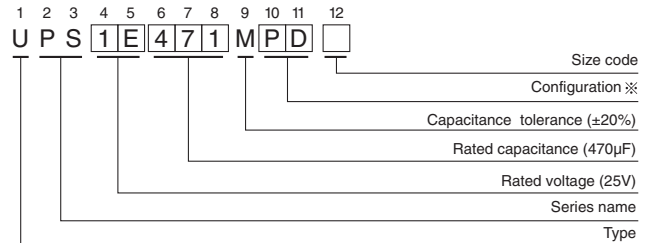

※ Configuration

φ D	Pb-free leadwire Pb-free PET sleeve
8 · 10	PD
12.5 to 18	HD

- Please refer to the Guidelines for Aluminum Electrolytic Capacitors for end seal configuration information.

Frequency coefficient of rated ripple current

Cap.(µF) \ Frequency	50Hz	120Hz	300Hz	1kHz	10kHz or more
22 to 47	—	0.17	0.40	0.65	1.00
100 to 220	0.30	0.50	0.65	0.80	1.00
330 to 680	0.57	0.71	0.82	0.90	1.00
1000 to 15000	0.75	0.87	0.96	0.98	1.00

• Dimension table in next page.

UPS

■ Dimensions

Rated Voltage (V) (code)	Rated Capacitance (μF)	Case Size φD×L (mm)	tan δ	Leakage Current (μA) (at 20°C after 1 minute)	Impedance (Ω) max. (20°C/100kHz)	Rated Ripple (mA rms) (105°C/100kHz)	Part Number
6.3 (0J)	470	8×11.5	0.24	88.83	0.28	410	UPS0J471MPD
	680	10×12.5	0.24	128.52	0.19	600	UPS0J681MPD
	1000	10×12.5	0.24	189	0.19	600	UPS0J102MPD
	1500	10×20	0.24	283.5	0.11	1000	UPS0J152MPD
	2200	12.5×20	0.26	415.8	0.075	1250	UPS0J222MHD
	3300	12.5×20	0.28	623.7	0.075	1250	UPS0J332MHD
	4700	16×25	0.30	888.3	0.038	1900	UPS0J472MHD
	6800	16×25	0.34	1285.2	0.038	1900	UPS0J682MHD
	10000	16×30.5	0.42	1890	0.033	2350	UPS0J103MHD
15000	18×35.5	0.52	2835	0.030	2700	UPS0J153MHD	
10 (1A)	330	8×11.5	0.20	99	0.28	410	UPS1A331MPD
	470	8×11.5	0.20	141	0.28	410	UPS1A471MPD
	680	10×12.5	0.20	204	0.19	600	UPS1A681MPD
	1000	10×16	0.20	300	0.14	800	UPS1A102MPD
	1500	10×20	0.20	450	0.11	1000	UPS1A152MPD
	2200	12.5×20	0.22	660	0.075	1250	UPS1A222MHD
	3300	12.5×25	0.24	990	0.057	1550	UPS1A332MHD
	4700	16×25	0.26	1410	0.038	1900	UPS1A472MHD
	6800	16×30.5	0.30	2040	0.033	2350	UPS1A682MHD
	10000	18×35.5	0.38	3000	0.030	2700	UPS1A103MHD
	15000	18×40	0.48	4500	0.027	3300	UPS1A153MHD
16 (1C)	220	8×11.5	0.16	105.6	0.28	410	UPS1C221MPD
	330	8×11.5	0.16	158.4	0.28	410	UPS1C331MPD
	470	10×12.5	0.16	225.6	0.19	600	UPS1C471MPD
	680	10×16	0.16	326.4	0.14	800	UPS1C681MPD
	1000	10×20	0.16	480	0.11	1000	UPS1C102MPD
	1500	12.5×20	0.16	720	0.075	1250	UPS1C152MHD
	2200	12.5×25	0.18	1056	0.057	1550	UPS1C222MHD
	3300	16×25	0.20	1584	0.038	1900	UPS1C332MHD
	4700	16×30.5	0.22	2256	0.033	2350	UPS1C472MHD
	6800	18×35.5	0.26	3264	0.030	2700	UPS1C682MHD
	10000	18×40	0.34	4800	0.027	3300	UPS1C103MHD
25 (1E)	150	8×11.5	0.14	112.5	0.28	410	UPS1E151MPD
	220	8×11.5	0.14	165	0.28	410	UPS1E221MPD
	330	10×12.5	0.14	247.5	0.19	600	UPS1E331MPD
	470	10×16	0.14	352.5	0.14	800	UPS1E471MPD
	680	10×20	0.14	510	0.11	1000	UPS1E681MPD
	1000	12.5×20	0.14	750	0.075	1250	UPS1E102MHD
	1500	16×25	0.14	1125	0.038	1900	UPS1E152MHD
	2200	16×25	0.16	1650	0.038	1900	UPS1E222MHD
	3300	16×30.5	0.18	2475	0.033	2350	UPS1E332MHD
	4700	18×35.5	0.20	3525	0.030	2700	UPS1E472MHD
	6800	18×40	0.24	5100	0.027	3300	UPS1E682MHD

For cut leads, formed leads or taped parts, please add the appropriate code after the size code (12th digit).
If there is no size code in the part number, please add size code "1" and then add the appropriate code.

UPS

■ Dimensions

Rated Voltage (V) (code)	Rated Capacitance (μF)	Case Size φD×L (mm)	tan δ	Leakage Current (μA) (at 20°C after 1 minute)	Impedance (Ω) max. (20°C/100kHz)	Rated Ripple (mA rms) (105°C/100kHz)	Part Number
35 (1V)	100	8×11.5	0.12	105	0.28	410	UPS1V101MPD
	150	8×11.5	0.12	157.5	0.28	410	UPS1V151MPD
	220	10×12.5	0.12	231	0.19	600	UPS1V221MPD
	330	10×16	0.12	346.5	0.14	800	UPS1V331MPD
	470	10×20	0.12	493.5	0.11	1000	UPS1V471MPD
	680	12.5×20	0.12	714	0.075	1250	UPS1V681MHD
	1000	12.5×25	0.12	1050	0.057	1550	UPS1V102MHD
	1500	16×25	0.12	1575	0.038	1900	UPS1V152MHD
	2200	16×30.5	0.14	2310	0.033	2350	UPS1V222MHD
	3300	18×35.5	0.16	3465	0.030	2700	UPS1V332MHD
4700	18×40	0.18	4935	0.027	3300	UPS1V472MHD	
50 (1H)	100	8×11.5	0.10	150	0.36	340	UPS1H101MPD
	150	10×12.5	0.10	225	0.26	490	UPS1H151MPD
	220	10×16	0.10	330	0.18	650	UPS1H221MPD
	330	10×20	0.10	495	0.15	810	UPS1H331MPD
	470	12.5×20	0.10	705	0.13	1100	UPS1H471MHD
	680	12.5×25	0.10	1020	0.10	1200	UPS1H681MHD
	1000	16×25	0.10	1500	0.058	1600	UPS1H102MHD
	1500	16×30.5	0.10	2250	0.040	2000	UPS1H152MHD
	2200	18×35.5	0.12	3300	0.035	2300	UPS1H222MHD
63 (1J)	47	8×11.5	0.09	88.83	0.65	310	UPS1J470MPD
	100	10×12.5	0.09	189	0.31	390	UPS1J101MPD
	150	10×16	0.09	283.5	0.25	440	UPS1J151MPD
	220	10×20	0.09	415.8	0.20	700	UPS1J221MPD
	330	12.5×20	0.09	623.7	0.12	980	UPS1J331MHD
	470	12.5×25	0.09	888.3	0.081	1200	UPS1J471MHD
	680	16×25	0.09	1285.2	0.058	1300	UPS1J681MHD
	1000	16×30.5	0.09	1890	0.049	1380	UPS1J102MHD
	1500	18×35.5	0.09	2835	0.038	1750	UPS1J152MHD
	2200	18×40	0.11	4158	0.032	2120	UPS1J222MHD
100 (2A)	22	8×11.5	0.08	66	0.68	230	UPS2A220MPD
	33	10×12.5	0.08	99	0.46	320	UPS2A330MPD
	47	10×16	0.08	141	0.37	420	UPS2A470MPD
	100	12.5×20	0.08	300	0.18	580	UPS2A101MHD
	150	12.5×25	0.08	450	0.13	710	UPS2A151MHD
	220	16×25	0.08	660	0.10	890	UPS2A221MHD
	330	16×25	0.08	990	0.090	1080	UPS2A331MHD
	470	16×30.5	0.08	1410	0.076	1310	UPS2A471MHD
	680	16×35.5	0.08	2040	0.064	1410	UPS2A681MHD
	1000	18×40	0.08	3000	0.047	1520	UPS2A102MHD

For cut leads, formed leads or taped parts, please add the appropriate code after the size code (12th digit).
If there is no size code in the part number, please add size code "1" and then add the appropriate code.

- For formed lead or taped product specifications and minimum order quantity, please refer to the Guidelines for Aluminum Electrolytic Capacitors.

ALUMINUM ELECTROLYTIC CAPACITORS

UPV Miniature Sized, Low Impedance,
High Reliability



- Miniature sized low impedance series withstanding 5000 hours load life at +105°C.
- Compliant to the RoHS directive (2011/65/EU,(EU)2015/863).

Valued marked with an ※ in the dimension table are scheduled to be discontinued and are not recommended for new designs.

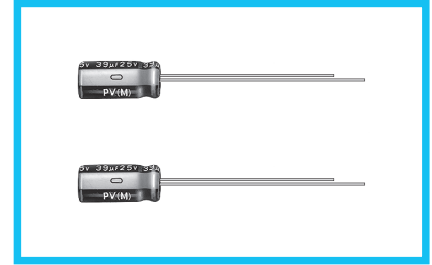

Specifications

Item	Performance Characteristics								
Category Temperature Range	-55 to +105°C								
Rated Voltage Range	6.3 to 50V								
Rated Capacitance Range	47 to 390μF								
Capacitance Tolerance	±20% at 120Hz, 20°C								
Leakage Current ※	After 1 minute's application of rated voltage at 20°C, leakage current is not more than 0.03CV (μA).								
Tangent of loss angle (tan δ)	Measurement frequency : 120Hz at 20°C								
	Rated voltage (V)	6.3	10	16	25	35	50		
	tan δ (max.)	0.22	0.19	0.16	0.14	0.12	0.10		
Stability at Low Temperature	Measurement frequency : 120Hz								
	Rated voltage (V)	6.3		10	16	25	35	50	
	Impedance ratio (max.)	Z(-55°C) / Z(+20°C)		5	5	4	3	3	2
Endurance	The specifications listed at right shall be met when the capacitors are restored to 20°C after the rated voltage is applied for 5000 hours at 105°C.		Capacitance change		Within ±30% of the initial capacitance value				
			tan δ		300% or less than the initial specified value				
			Leakage current		Less than or equal to the initial specified value				
Shelf Life	After storing the capacitors under no load at 105°C for 1000 hours and then performing voltage treatment based on JIS C 5101-4 clause 4.1 at 20°C, they shall meet the specified values for the endurance characteristics listed at right.		Capacitance change		Within ±20% of the initial capacitance value				
			tan δ		150% or less than the initial specified value				
			Leakage current		Less than or equal to the initial specified value				
Marking	Printed with white color letter on dark brown sleeve.								

※ I : Leakage Current (μA), C : Rated Capacitance (μF), V : Rated Voltage (V)

Radial Lead Type

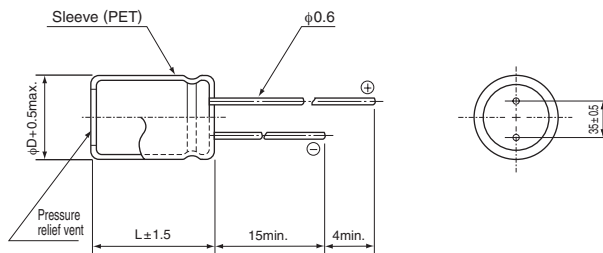

Type numbering system (Example : 25V 100μF)

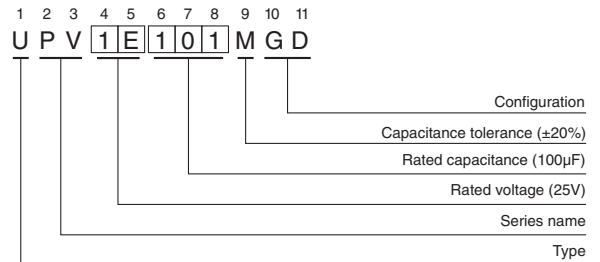

• Please refer to the Guidelines for Aluminum Electrolytic Capacitors for end seal configuration information.

• Frequency coefficient of rated ripple current (10kHz to 200kHz=1)

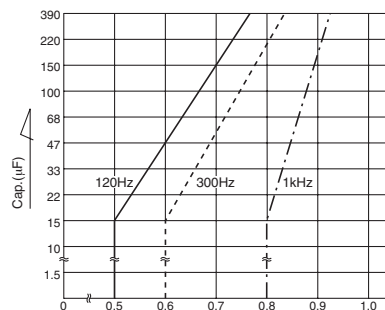

• Dimension table in next page.

UPV

■ Dimensions

Rated Voltage (V) (code)	Rated Capacitance (μF)	Case Size φD×L (mm)	tan δ	Leakage Current (μA) (at 20°C after 1 minute)	Impedance (Ω) max. (20°C/100kHz)	Rated Ripple (mArms) (105°C/100kHz)	Part Number
6.3 (0J)	270	8×11.5	0.22	51.03	0.41	370	※UPV0J271MGD
	330	8×11.5	0.22	62.37	0.34	405	※UPV0J331MGD
	390	8×11.5	0.22	73.71	0.29	445	※UPV0J391MGD
10 (1A)	220	8×11.5	0.19	66	0.41	370	※UPV1A221MGD
	270	8×11.5	0.19	81	0.34	405	※UPV1A271MGD
	330	8×11.5	0.19	99	0.27	460	※UPV1A331MGD
16 (1C)	150	8×11.5	0.16	72	0.39	375	UPV1C151MGD
	180	8×11.5	0.16	86.4	0.34	405	UPV1C181MGD
	220	8×11.5	0.16	105.6	0.27	460	UPV1C221MGD
25 (1E)	100	8×11.5	0.14	75	0.41	370	UPV1E101MGD
	120	8×11.5	0.14	90	0.34	405	UPV1E121MGD
	150	8×11.5	0.14	112.5	0.27	460	UPV1E151MGD
35 (1V)	68	8×11.5	0.12	71.4	0.41	370	UPV1V680MGD
	82	8×11.5	0.12	86.1	0.32	415	UPV1V820MGD
	100	8×11.5	0.12	105	0.27	460	UPV1V101MGD
50 (1H)	47	8×11.5	0.10	70.5	0.42	330	UPV1H470MGD
	56	8×11.5	0.10	84	0.35	360	UPV1H560MGD
	68	8×11.5	0.10	102	0.28	410	UPV1H680MGD

For cut leads, formed leads or taped parts, please add the appropriate code after the size code (12th digit).
If there is no size code in the part number, please add size code "1" and then add the appropriate code.

- For formed lead or taped product specifications and minimum order quantity, please refer to the Guidelines for Aluminum Electrolytic Capacitors.

UPT Miniature Sized, High Ripple Current, Long Life



- High ripple current.
- Suited for ballast application.
- Compliant to the RoHS directive (2011/65/EU,(EU)2015/863).

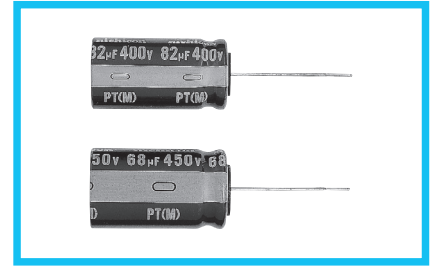
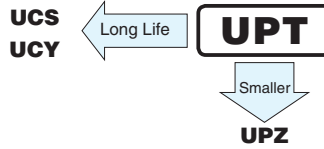

Specifications

Item	Performance Characteristics															
Category Temperature Range	-40 to +105°C															
Rated Voltage Range	200 to 450V															
Rated Capacitance Range	15 to 390µF															
Capacitance Tolerance	±20% at 120Hz, 20°C															
Leakage Current ※	After 2 minutes' application of rated voltage at 20°C, leakage current is not more than 0.06CV+10 (µA)															
Tangent of loss angle (tan δ)	Measurement frequency : 120Hz at 20°C															
	<table border="1"> <tr> <td>Rated voltage (V)</td> <td>200</td> <td>220</td> <td>250</td> <td>400</td> <td>420</td> <td>450</td> </tr> <tr> <td>tan δ (max.)</td> <td>0.12</td> <td>0.12</td> <td>0.12</td> <td>0.15</td> <td>0.20</td> <td>0.20</td> </tr> </table>	Rated voltage (V)	200	220	250	400	420	450	tan δ (max.)	0.12	0.12	0.12	0.15	0.20	0.20	
Rated voltage (V)	200	220	250	400	420	450										
tan δ (max.)	0.12	0.12	0.12	0.15	0.20	0.20										
Stability at Low Temperature	Measurement frequency : 120Hz															
	<table border="1"> <tr> <td colspan="2">Rated voltage (V)</td> <td>200</td> <td>220</td> <td>250</td> <td>400</td> <td>420</td> <td>450</td> </tr> <tr> <td>Impedance ratio (max.)</td> <td>Z(-25°C) / Z(+20°C)</td> <td>3</td> <td>3</td> <td>3</td> <td>8</td> <td>8</td> <td>8</td> </tr> </table>	Rated voltage (V)		200	220	250	400	420	450	Impedance ratio (max.)	Z(-25°C) / Z(+20°C)	3	3	3	8	8
Rated voltage (V)		200	220	250	400	420	450									
Impedance ratio (max.)	Z(-25°C) / Z(+20°C)	3	3	3	8	8	8									
Endurance	<p>The specifications listed at right shall be met when the capacitors are restored to 20°C after D.C. bias plus rated ripple current is applied for 5000 hours at 105°C, the peak voltage shall not exceed the rated voltage.</p> <table border="1"> <tr> <td>Capacitance change</td> <td>Within ±20% of the initial capacitance value</td> </tr> <tr> <td>tan δ</td> <td>200% or less than the initial specified value</td> </tr> <tr> <td>Leakage current</td> <td>Less than or equal to the initial specified value</td> </tr> </table>	Capacitance change	Within ±20% of the initial capacitance value	tan δ	200% or less than the initial specified value	Leakage current	Less than or equal to the initial specified value									
Capacitance change	Within ±20% of the initial capacitance value															
tan δ	200% or less than the initial specified value															
Leakage current	Less than or equal to the initial specified value															
Shelf Life	After storing the capacitors under no load at 105°C for 1000 hours and then performing voltage treatment based on JIS C 5101-4 clause 4.1 at 20°C, they shall meet the specified values for the endurance characteristics listed above.															
Marking	Printed with white color letter on dark brown sleeve.															

※ I : Leakage Current (µA), C : Rated Capacitance (µF), V : Rated Voltage (V)

Radial Lead Type

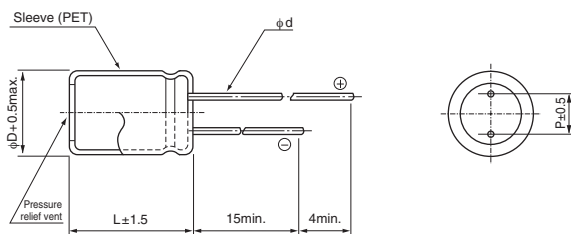

	(mm)			
φD	10	12.5	16	18
P	5.0	5.0	7.5	7.5
φd	0.6	0.6°	0.8	0.8

※ In case L > 25 for the φ12.5 dia. unit, lead dia. φ d = 0.8mm.

- Please refer to the Guidelines for Aluminum Electrolytic Capacitors for end seal configuration information.

Type numbering system (Example : 250V 220µF)

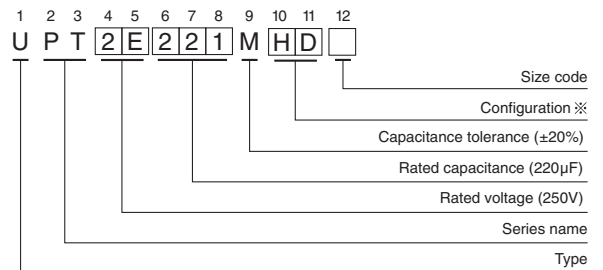

※ Configuration

φ D	Pb-free leadwire Pb-free PET sleeve
10	PD
12.5 to 18	HD

Frequency coefficient of rated ripple current

Frequency	50Hz	120Hz	300Hz	1kHz	10kHz or more
Coefficient	0.80	1.00	1.25	1.40	1.60

● Dimension table in next page.

UPT

■ Dimensions

Rated Voltage (V) (code)	Rated Capacitance (μF)	Case Size φD×L (mm)	tan δ	Leakage Current (μA) (at 20°C after 2 minutes)	Rated Ripple (mArms) (105°C/120Hz)	Part Number
200 (2D)	68	10×30.5	0.12	826	350	UPT2D680MPD
	82	12.5×25	0.12	994	410	UPT2D820MHD
	100	12.5×30.5	0.12	1210	480	UPT2D101MHD
	120	12.5×30.5	0.12	1450	530	UPT2D121MHD
	150	12.5×35.5	0.12	1810	620	UPT2D151MHD
	180	12.5×40	0.12	2170	700	UPT2D181MHD
	220	16×30.5	0.12	2650	760	UPT2D221MHD
	220	18×30.5	0.12	2650	810	UPT2D221MHD6
	270	16×35.5	0.12	3250	880	UPT2D271MHD
	270	18×30.5	0.12	3250	870	UPT2D271MHD6
	330	18×35.5	0.12	3970	1010	UPT2D331MHD
	390	18×40	0.12	4690	1130	UPT2D391MHD
220 (2P)	56	10×30.5	0.12	749.2	290	UPT2P560MPD
	68	12.5×25	0.12	907.6	340	UPT2P680MHD
	82	12.5×30.5	0.12	1092.4	390	UPT2P820MHD
	100	12.5×30.5	0.12	1330	430	UPT2P101MHD
	120	12.5×35.5	0.12	1594	490	UPT2P121MHD
	150	12.5×40	0.12	1990	580	UPT2P151MHD
	180	16×30.5	0.12	2386	670	UPT2P181MHD
	220	16×35.5	0.12	2914	770	UPT2P221MHD
	220	18×30.5	0.12	2914	770	UPT2P221MHD6
	270	16×40	0.12	3574	880	UPT2P271MHD
	270	18×35.5	0.12	3574	880	UPT2P271MHD6
	330	18×40	0.12	4366	1010	UPT2P331MHD
250 (2E)	47	10×30.5	0.12	715	270	UPT2E470MPD
	56	12.5×25	0.12	850	310	UPT2E560MHD
	68	12.5×30.5	0.12	1030	360	UPT2E680MHD
	82	12.5×30.5	0.12	1240	400	UPT2E820MHD
	100	12.5×35.5	0.12	1510	460	UPT2E101MHD
	120	12.5×40	0.12	1810	530	UPT2E121MHD
	150	16×30.5	0.12	2260	620	UPT2E151MHD
	180	16×35.5	0.12	2710	720	UPT2E181MHD
	180	18×30.5	0.12	2710	720	UPT2E181MHD6
	220	16×40	0.12	3310	830	UPT2E221MHD
	220	18×35.5	0.12	3310	830	UPT2E221MHD6
	270	18×40	0.12	4060	950	UPT2E271MHD

For cut leads, formed leads or taped parts, please add the appropriate code after the size code (12th digit).
If there is no size code in the part number, please add size code "1" and then add the appropriate code.

UPT

■ Dimensions

Rated Voltage (V) (code)	Rated Capacitance (μF)	Case Size φD×L (mm)	tan δ	Leakage Current (μA) (at 20°C after 2 minutes)	Rated Ripple (mArms) (105°C/120Hz)	Part Number
400 (2G)	22	10×30.5	0.15	538	210	UPT2G220MPD
	27	12.5×25	0.15	658	240	UPT2G270MHD
	33	12.5×30.5	0.15	802	290	UPT2G330MHD
	39	12.5×30.5	0.15	946	320	UPT2G390MHD
	47	12.5×35.5	0.15	1138	370	UPT2G470MHD
	56	12.5×40	0.15	1354	420	UPT2G560MHD
	68	16×30.5	0.15	1642	460	UPT2G680MHD
	82	16×30.5	0.15	1978	500	UPT2G820MHD
	100	16×35.5	0.15	2410	580	UPT2G101MHD
	100	18×30.5	0.15	2410	580	UPT2G101MHD6
	120	16×40	0.15	2890	660	UPT2G121MHD
	120	18×35.5	0.15	2890	670	UPT2G121MHD6
	150	18×40	0.15	3610	770	UPT2G151MHD
420 (W6)	18	10×30.5	0.20	463.6	170	UPTW6180MPD
	22	12.5×25	0.20	564.4	200	UPTW6220MHD
	27	12.5×30.5	0.20	690.4	240	UPTW6270MHD
	33	12.5×30.5	0.20	841.6	270	UPTW6330MHD
	39	12.5×35.5	0.20	992.8	310	UPTW6390MHD
	47	12.5×40	0.20	1194.4	360	UPTW6470MHD
	56	16×30.5	0.20	1421.2	430	UPTW6560MHD
	68	16×35.5	0.20	1723.6	510	UPTW6680MHD
	68	18×30.5	0.20	1723.6	510	UPTW6680MHD6
	82	16×40	0.20	2076.4	570	UPTW6820MHD
	82	18×30.5	0.20	2076.4	570	UPTW6820MHD6
	100	18×35.5	0.20	2530	610	UPTW6101MHD
	120	18×40	0.20	3034	660	UPTW6121MHD
450 (2W)	15	10×30.5	0.20	415	150	UPT2W150MPD
	18	12.5×25	0.20	496	180	UPT2W180MHD
	22	12.5×30.5	0.20	604	220	UPT2W220MHD
	27	12.5×30.5	0.20	739	250	UPT2W270MHD
	33	12.5×35.5	0.20	901	280	UPT2W330MHD
	39	12.5×40	0.20	1063	320	UPT2W390MHD
	47	16×30.5	0.20	1279	380	UPT2W470MHD
	56	16×35.5	0.20	1522	440	UPT2W560MHD
	68	16×40	0.20	1846	490	UPT2W680MHD
	68	18×30.5	0.20	1846	480	UPT2W680MHD6
	82	18×35.5	0.20	2224	550	UPT2W820MHD
	100	18×40	0.20	2710	650	UPT2W101MHD

For cut leads, formed leads or taped parts, please add the appropriate code after the size code (12th digit).
If there is no size code in the part number, please add size code "1" and then add the appropriate code.

- For formed lead or taped product specifications and minimum order quantity, please refer to the Guidelines for Aluminum Electrolytic Capacitors.

UPZ

High Voltage, Miniature-sized



- High ripple current.
- Load life of 2000 hours at 105°C.
- Suited for ballast applications.
- Compliant to the RoHS directive (2011/65/EU,(EU)2015/863).

Valued marked with an ※ in the dimension table are scheduled to be discontinued and are not recommended for new designs.

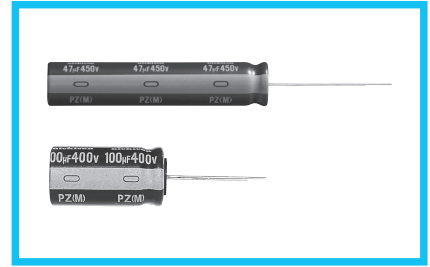
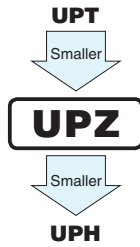

Specifications

Item	Performance Characteristics												
Category Temperature Range	-40 to +105°C												
Rated Voltage Range	200 to 450V												
Rated Capacitance Range	18 to 470μF												
Capacitance Tolerance	±20% at 120Hz, 20°C												
Leakage Current ※	After 1 minute's application of rated voltage at 20°C, leakage current is not more than 0.04CV+100 (μA).												
Tangent of loss angle (tan δ)	Measurement frequency : 120Hz at 20°C												
	<table border="1"> <tr> <td>Rated voltage (V)</td> <td>200</td> <td>250</td> <td>400</td> <td>420</td> <td>450</td> </tr> <tr> <td>tan δ (max.)</td> <td>0.12</td> <td>0.15</td> <td>0.15</td> <td>0.20</td> <td>0.20</td> </tr> </table>	Rated voltage (V)	200	250	400	420	450	tan δ (max.)	0.12	0.15	0.15	0.20	0.20
Rated voltage (V)	200	250	400	420	450								
tan δ (max.)	0.12	0.15	0.15	0.20	0.20								
Stability at Low Temperature	Measurement frequency : 120Hz												
	<table border="1"> <tr> <td>Rated voltage (V)</td> <td>200</td> <td>250</td> <td>400</td> <td>420</td> <td>450</td> </tr> <tr> <td>Impedance ratio (max.)</td> <td>Z(-25°C) / Z(+20°C)</td> <td>3</td> <td>3</td> <td>8</td> <td>8</td> <td>8</td> </tr> </table>	Rated voltage (V)	200	250	400	420	450	Impedance ratio (max.)	Z(-25°C) / Z(+20°C)	3	3	8	8
Rated voltage (V)	200	250	400	420	450								
Impedance ratio (max.)	Z(-25°C) / Z(+20°C)	3	3	8	8	8							
Endurance	<p>The specifications listed at right shall be met when the capacitors are restored to 20°C after D.C. bias plus rated ripple current is applied for 2000 hours at 105°C, the peak voltage shall not exceed the rated voltage.</p> <table border="1"> <tr> <td>Capacitance change</td> <td>Within ±20% of the initial capacitance value</td> </tr> <tr> <td>tan δ</td> <td>200% or less than the initial specified value</td> </tr> <tr> <td>Leakage current</td> <td>Less than or equal to the initial specified value</td> </tr> </table>	Capacitance change	Within ±20% of the initial capacitance value	tan δ	200% or less than the initial specified value	Leakage current	Less than or equal to the initial specified value						
Capacitance change	Within ±20% of the initial capacitance value												
tan δ	200% or less than the initial specified value												
Leakage current	Less than or equal to the initial specified value												
Shelf Life	After storing the capacitors under no load at 105°C for 1000 hours and then performing voltage treatment based on JIS C 5101-4 clause 4.1 at 20°C, they shall meet the specified values for the endurance characteristics listed above.												
Marking	Printed with white color letter on dark brown sleeve.												

※ I : Leakage Current (μA), C : Rated Capacitance (μF), V : Rated Voltage (V)

Radial Lead Type

- The 12th digit of the part number is 9 or none.

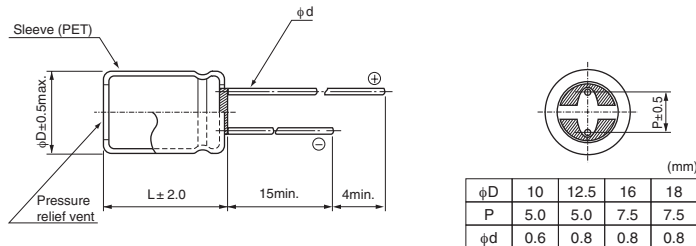

Type numbering system (Example : 200V 220μF)

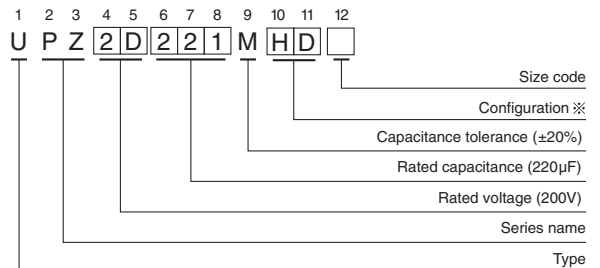

※ Configuration

Size code	Blank, 6	9 (Not recommended)
φ D	Pb-free leadwire	Pb-free PET sleeve
10	PD	ND
12.5 to 18	HD	NY

Pencil - shaped Type

- 9 in the 12th digit of the part number.

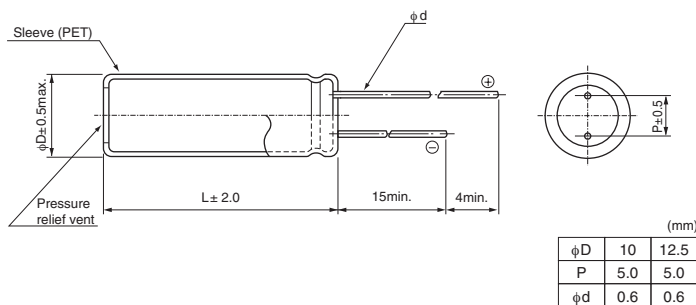

Frequency coefficient of rated ripple current

V	60Hz	120Hz	500Hz	1kHz	10kHz or more
200・250	0.80	1.00	1.20	1.30	1.40
400 to 450	0.80	1.00	1.25	1.40	1.50

● Please refer to the Guidelines for Aluminum Electrolytic Capacitors for end seal configuration information.

● Dimension table in next page.

UPZ

■ Dimensions

Rated Voltage (V) (code)	Rated Capacitance (μF)	Case Size φD×L (mm)	tan δ	Leakage Current (μA) (at 20°C after 1 minute)	Rated Ripple (mArms) (105°C/120Hz)	Part Number
200 (2D)	82	10×30.5	0.12	756	400	UPZ2D820MPD
	120	10×40	0.12	1060	680	※UPZ2D121MND9
	150	12.5×30.5	0.12	1300	620	UPZ2D151MHD
	150	10×50	0.12	1300	830	※UPZ2D151MND9
	180	12.5×35.5	0.12	1540	700	UPZ2D181MHD
	220	12.5×40	0.12	1860	800	UPZ2D221MHD
	270	16×30.5	0.12	2260	870	UPZ2D271MHD
	270	12.5×50	0.12	2260	1265	※UPZ2D271MNY9
	330	16×35.5	0.12	2740	1010	UPZ2D331MHD
	330	18×30.5	0.12	2740	1010	UPZ2D331MHD6
	390	16×40	0.12	3220	1130	UPZ2D391MHD
	390	18×35.5	0.12	3220	1120	UPZ2D391MHD6
	470	18×40	0.12	3860	1270	UPZ2D471MHD
250 (2E)	82	10×40	0.15	920	610	※UPZ2E820MND9
	120	10×50	0.15	1300	740	※UPZ2E121MND9
	220	12.5×50	0.15	2300	1140	※UPZ2E221MNY9
400 (2G)	27	10×30.5	0.15	532	240	UPZ2G270MPD
	47	12.5×30.5	0.15	852	370	UPZ2G470MHD
	47	10×40	0.15	852	435	※UPZ2G470MND9
	56	12.5×35.5	0.15	996	420	UPZ2G560MHD
	56	10×50	0.15	996	520	※UPZ2G560MND9
	68	12.5×40	0.15	1188	480	UPZ2G680MHD
	100	16×30.5	0.15	1700	580	UPZ2G101MHD
	100	12.5×50	0.15	1700	770	※UPZ2G101MNY9
	120	16×35.5	0.15	2020	670	UPZ2G121MHD
	120	18×30.5	0.15	2020	670	UPZ2G121MHD6
	150	16×40	0.15	2500	770	UPZ2G151MHD
	150	18×35.5	0.15	2500	770	UPZ2G151MHD6
180	18×40	0.15	2980	880	UPZ2G181MHD	
420 (W6)	22	10×30.5	0.20	469.6	200	UPZW6220MPD
	39	12.5×30.5	0.20	755.2	310	UPZW6390MHD
	47	12.5×35.5	0.20	889.6	360	UPZW6470MHD
	56	12.5×40	0.20	1040.8	430	UPZW6560MHD
	68	16×30.5	0.20	1242.4	510	UPZW6680MHD
	82	16×35.5	0.20	1477.6	570	UPZW6820MHD
	100	16×40	0.20	1780	610	UPZW6101MHD
	100	18×30.5	0.20	1780	610	UPZW6101MHD6
	120	18×35.5	0.20	2116	660	UPZW6121MHD
150	18×40	0.20	2620	710	UPZW6151MHD	

For cut leads, formed leads or taped parts, please add the appropriate code after the size code (12th digit).
If there is no size code in the part number, please add size code "1" and then add the appropriate code.

UPZ

■Dimensions

Rated Voltage (V) (code)	Rated Capacitance (μ F)	Case Size ϕ D×L (mm)	tan δ	Leakage Current (μ A) (at 20°C after 1 minute)	Rated Ripple (mArms) (105°C/120Hz)	Part Number
450 (2W)	18	10×30.5	0.20	424	180	UPZ2W180MPD
	33	12.5×30.5	0.20	694	280	UPZ2W330MHD
	33	10×40	0.20	694	360	※UPZ2W330MND9
	39	12.5×35.5	0.20	802	320	UPZ2W390MHD
	47	12.5×40	0.20	946	380	UPZ2W470MHD
	47	10×50	0.20	946	450	※UPZ2W470MND9
	56	16×30.5	0.20	1108	440	UPZ2W560MHD
	68	16×35.5	0.20	1324	490	UPZ2W680MHD
	82	16×40	0.20	1576	550	UPZ2W820MHD
	82	18×30.5	0.20	1576	550	UPZ2W820MHD6
	82	12.5×50	0.20	1576	730	※UPZ2W820MNY9
	100	18×35.5	0.20	1900	650	UPZ2W101MHD
	120	18×40	0.20	2260	740	UPZ2W121MHD

For cut leads, formed leads or taped parts, please add the appropriate code after the size code (12th digit).
If there is no size code in the part number, please add size code "1" and then add the appropriate code.

- For formed lead or taped product specifications and minimum order quantity, please refer to the Guidelines for Aluminum Electrolytic Capacitors.

UPH

High Voltage, Miniature-sized



- High ripple current.
- Load life of 2000 hours at 105°C.
- Suited for ballast applications.
- Compliant to the RoHS directive (2011/65/EU,(EU)2015/863).

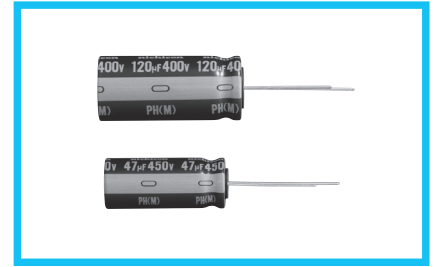
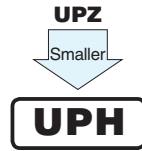

Specifications

Item	Performance Characteristics								
Category Temperature Range	-40 to +105°C								
Rated Voltage Range	400 to 450V								
Rated Capacitance Range	27 to 220µF								
Capacitance Tolerance	±20% at 120Hz, 20°C								
Leakage Current ※	After 1 minute's application of rated voltage at 20°C, leakage current is not more than 0.04CV+100 (µA).								
Tangent of loss angle (tan δ)	Measurement frequency : 120Hz at 20°C								
	<table border="1"> <tr> <td>Rated voltage (V)</td> <td>400</td> <td>420</td> <td>450</td> </tr> <tr> <td>tan δ (max.)</td> <td>0.15</td> <td>0.20</td> <td>0.20</td> </tr> </table>	Rated voltage (V)	400	420	450	tan δ (max.)	0.15	0.20	0.20
Rated voltage (V)	400	420	450						
tan δ (max.)	0.15	0.20	0.20						
Stability at Low Temperature	Measurement frequency : 120Hz								
	<table border="1"> <tr> <td>Rated voltage (V)</td> <td>400</td> <td>420</td> <td>450</td> </tr> <tr> <td>Impedance ratio (max.)</td> <td>Z(-25°C) / Z(+20°C)</td> <td>8</td> <td>8</td> <td>8</td> </tr> </table>	Rated voltage (V)	400	420	450	Impedance ratio (max.)	Z(-25°C) / Z(+20°C)	8	8
Rated voltage (V)	400	420	450						
Impedance ratio (max.)	Z(-25°C) / Z(+20°C)	8	8	8					
Endurance	<p>The specifications listed at right shall be met when the capacitors are restored to 20°C after D.C. bias plus rated ripple current is applied for 2000 hours at 105°C, the peak voltage shall not exceed the rated voltage.</p> <table border="1"> <tr> <td>Capacitance change</td> <td>Within ±20% of the initial capacitance value</td> </tr> <tr> <td>tan δ</td> <td>200% or less than the initial specified value</td> </tr> <tr> <td>Leakage current</td> <td>Less than or equal to the initial specified value</td> </tr> </table>	Capacitance change	Within ±20% of the initial capacitance value	tan δ	200% or less than the initial specified value	Leakage current	Less than or equal to the initial specified value		
Capacitance change	Within ±20% of the initial capacitance value								
tan δ	200% or less than the initial specified value								
Leakage current	Less than or equal to the initial specified value								
Shelf Life	After storing the capacitors under no load at 105°C for 1000 hours and then performing voltage treatment based on JIS C 5101-4 clause 4.1 at 20°C, they shall meet the specified values for the endurance characteristics listed above.								
Marking	Printed with white color letter on dark brown sleeve.								

※ I : Leakage Current (µA), C : Rated Capacitance (µF), V : Rated Voltage (V)

Radial Lead Type

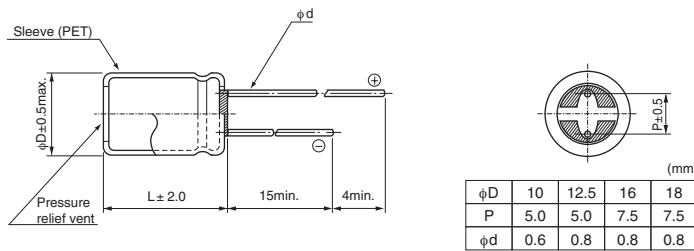

- Please refer to the Guidelines for Aluminum Electrolytic Capacitors for end seal configuration information.

Type numbering system (Example : 400V 220µF)

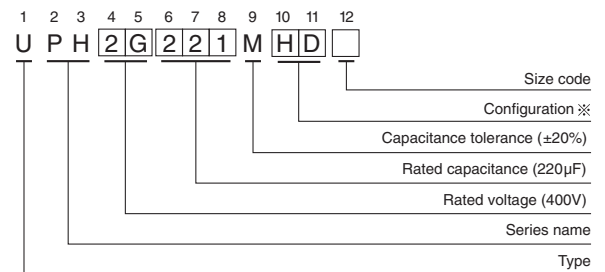

※ Configuration

φ D	Pb-free leadwire Pb-free PET sleeve
10	PD
12.5 to 18	HD

Frequency coefficient of rated ripple current

Frequency	60Hz	120Hz	500Hz	1kHz	10kHz or more
Coefficient	0.80	1.00	1.25	1.40	1.50

● Dimension table in next page.

UPH

■ Dimensions

Rated Voltage (V) (code)	Rated Capacitance (μF)	Case Size φD×L (mm)	tan δ	Leakage Current (μA) (at 20°C after 1 minute)	Rated Ripple (mArms) (105°C/120Hz)	Part Number
400 (2G)	33	10×31.5	0.15	628	330	UPH2G330MPD
	56	12.5×31.5	0.15	996	470	UPH2G560MHD
	68	12.5×35.5	0.15	1188	540	UPH2G680MHD
	82	12.5×40	0.15	1412	620	UPH2G820MHD
	100	16×31.5	0.15	1700	710	UPH2G101MHD
	120	16×35.5	0.15	2020	800	UPH2G121MHD
	150	16×40	0.15	2500	920	UPH2G151MHD
	150	18×31.5	0.15	2500	890	UPH2G151MHD6
	180	18×40	0.15	2980	1060	UPH2G181MHD
420 (W6)	33	10×31.5	0.20	654.4	320	UPHW6330MPD
	56	12.5×31.5	0.20	1040.8	460	UPHW6560MHD
	100	16×31.5	0.20	1780	690	UPHW6101MHD
	120	16×35.5	0.20	2116	780	UPHW6121MHD
	120	18×31.5	0.20	2116	800	UPHW6121MHD6
	150	18×35.5	0.20	2620	920	UPHW6151MHD
	180	18×40	0.20	3124	1040	UPHW6181MHD
450 (2W)	27	10×31.5	0.20	586	300	UPH2W270MPD
	47	12.5×31.5	0.20	946	430	UPH2W470MHD
	56	12.5×35.5	0.20	1108	490	UPH2W560MHD
	68	12.5×40	0.20	1324	560	UPH2W680MHD
	82	16×31.5	0.20	1576	640	UPH2W820MHD
	100	16×35.5	0.20	1900	730	UPH2W101MHD
	120	16×40	0.20	2260	820	UPH2W121MHD
	120	18×31.5	0.20	2260	800	UPH2W121MHD6
	150	18×40	0.20	2800	970	UPH2W151MHD
180	18×46	0.20	3340	1090	UPH2W181MHD	

For cut leads, formed leads or taped parts, please add the appropriate code after the size code (12th digit).
If there is no size code in the part number, please add size code "1" and then add the appropriate code.

- For formed lead or taped product specifications and minimum order quantity, please refer to the Guidelines for Aluminum Electrolytic Capacitors.

ALUMINUM ELECTROLYTIC CAPACITORS

UCP

High Voltage, Miniature sized, Long Life Assurance



- High ripple current.
- Load life of 10000 hours at 105°C.
- Suited for ballast applications.
- Compliant to the RoHS directive (2011/65/EU,(EU)2015/863).

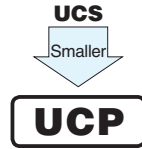

Specifications

Item	Performance Characteristics								
Category Temperature Range	-40 to +105°C								
Rated Voltage Range	400 to 450V								
Rated Capacitance Range	27 to 220µF								
Capacitance Tolerance	±20% at 120Hz, 20°C								
Leakage Current ※	After 1 minute's application of rated voltage at 20°C, leakage current is not more than $I=0.04CV+100$ (µA).								
Tangent of loss angle (tan δ)	Measurement frequency : 120Hz at 20°C								
	<table border="1"> <tr> <td>Rated voltage (V)</td> <td>400</td> <td>420</td> <td>450</td> </tr> <tr> <td>tan δ (max.)</td> <td>0.24</td> <td>0.24</td> <td>0.24</td> </tr> </table>	Rated voltage (V)	400	420	450	tan δ (max.)	0.24	0.24	0.24
Rated voltage (V)	400	420	450						
tan δ (max.)	0.24	0.24	0.24						
Stability at Low Temperature	Measurement frequency : 120Hz								
	<table border="1"> <tr> <td>Rated voltage (V)</td> <td>400</td> <td>420</td> <td>450</td> </tr> <tr> <td>Impedance ratio (max.)</td> <td>$Z(-25°C) / Z(+20°C)$</td> <td>8</td> <td>8</td> <td>8</td> </tr> </table>	Rated voltage (V)	400	420	450	Impedance ratio (max.)	$Z(-25°C) / Z(+20°C)$	8	8
Rated voltage (V)	400	420	450						
Impedance ratio (max.)	$Z(-25°C) / Z(+20°C)$	8	8	8					
Endurance	<p>The specifications listed at right shall be met when the capacitors are restored to 20°C after D.C. bias plus rated ripple current is applied for 10000 hours at 105°C, the peak voltage shall not exceed the rated voltage.</p> <table border="1"> <tr> <td>Capacitance change</td> <td>Within ±20% of the initial capacitance value</td> </tr> <tr> <td>tan δ</td> <td>200% or less than the initial specified value</td> </tr> <tr> <td>Leakage current</td> <td>Less than or equal to the initial specified value</td> </tr> </table>	Capacitance change	Within ±20% of the initial capacitance value	tan δ	200% or less than the initial specified value	Leakage current	Less than or equal to the initial specified value		
Capacitance change	Within ±20% of the initial capacitance value								
tan δ	200% or less than the initial specified value								
Leakage current	Less than or equal to the initial specified value								
Shelf Life	After storing the capacitors under no load at 105°C for 1000 hours and then performing voltage treatment based on JIS C 5101-4 clause 4.1 at 20°C, they shall meet the specified values for the endurance characteristics listed above.								
Marking	Printed with white color letter on dark brown sleeve.								

※ I : Leakage Current (µA), C : Rated Capacitance (µF), V : Rated Voltage (V)

Radial Lead Type

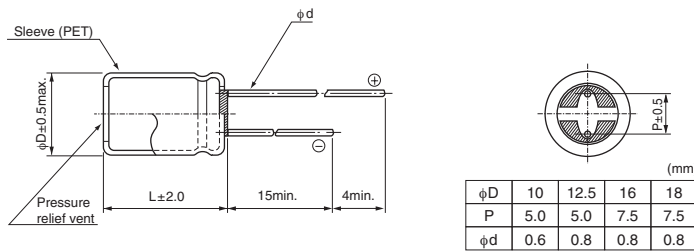

● Please refer to the Guidelines for Aluminum Electrolytic Capacitors for end seal configuration information.

Type numbering system (Example : 400V 220µF)

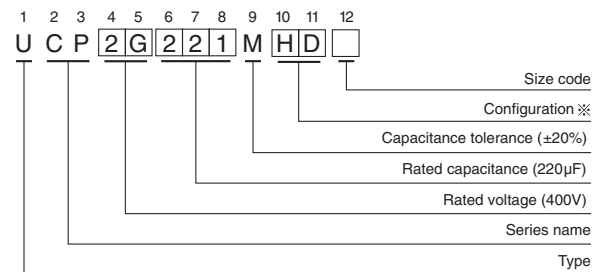

※ Configuration

φ D	Pb-free leadwire Pb-free PET sleeve
10	PD
12.5 to 18	HD

Frequency coefficient of rated ripple current

Frequency	60Hz	120Hz	500Hz	1kHz	10kHz or more
Coefficient	0.80	1.00	1.25	1.40	1.50

● Dimension table in next page.

UCP

■ Dimensions

Rated Voltage (V) (code)	Rated Capacitance (μ F)	Case Size ϕ D \times L (mm)	$\tan \delta$	Leakage Current (μ A) (at 20°C after 1 minute)	Rated Ripple (mArms) (105°C/120Hz)	Part Number
400 (2G)	33	10 \times 31.5	0.24	628	330	UCP2G330MPD
	56	12.5 \times 31.5	0.24	996	470	UCP2G560MHD
	68	12.5 \times 35.5	0.24	1188	540	UCP2G680MHD
	82	12.5 \times 40	0.24	1412	620	UCP2G820MHD
	100	16 \times 31.5	0.24	1700	710	UCP2G101MHD
	120	16 \times 35.5	0.24	2020	800	UCP2G121MHD
	150	16 \times 40	0.24	2500	920	UCP2G151MHD
	150	18 \times 31.5	0.24	2500	890	UCP2G151MHD6
	180	18 \times 40	0.24	2980	1060	UCP2G181MHD
	220	18 \times 46	0.24	3620	1200	UCP2G221MHD
420 (W6)	33	10 \times 31.5	0.24	654.4	320	UCPW6330MPD
	56	12.5 \times 31.5	0.24	1040.8	460	UCPW6560MHD
	100	16 \times 31.5	0.24	1780	690	UCPW6101MHD
	120	16 \times 35.5	0.24	2116	780	UCPW6121MHD
	120	18 \times 31.5	0.24	2116	800	UCPW6121MHD6
	150	18 \times 35.5	0.24	2620	920	UCPW6151MHD
	180	18 \times 40	0.24	3124	1040	UCPW6181MHD
450 (2W)	27	10 \times 31.5	0.24	586	300	UCP2W270MPD
	47	12.5 \times 31.5	0.24	946	430	UCP2W470MHD
	56	12.5 \times 35.5	0.24	1108	490	UCP2W560MHD
	68	12.5 \times 40	0.24	1324	560	UCP2W680MHD
	82	16 \times 31.5	0.24	1576	640	UCP2W820MHD
	100	16 \times 35.5	0.24	1900	730	UCP2W101MHD
	120	16 \times 40	0.24	2260	820	UCP2W121MHD
	120	18 \times 31.5	0.24	2260	800	UCP2W121MHD6
	150	18 \times 40	0.24	2800	970	UCP2W151MHD
	180	18 \times 46	0.24	3340	1090	UCP2W181MHD

For cut leads, formed leads or taped parts, please add the appropriate code after the size code (12th digit).
If there is no size code in the part number, please add size code "1" and then add the appropriate code.

- For formed lead or taped product specifications and minimum order quantity, please refer to the Guidelines for Aluminum Electrolytic Capacitors.

ALUMINUM ELECTROLYTIC CAPACITORS

ULD

Miniature sized, Long Life Assurance



- Long Life product withstanding load life of 10000 hours at +105°C.
- Suited for the power supply for LED lighting.
- Compliant to the RoHS directive (2011/65/EU, (EU)2015/863).

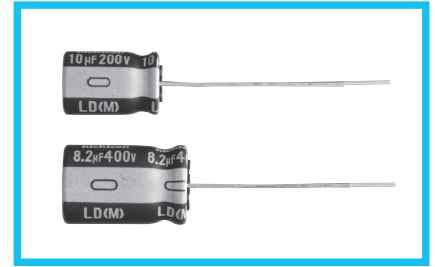

Valued marked with an ※ in the dimension table are scheduled to be discontinued and are not recommended for new designs.

Specifications

Item	Performance Characteristics	
Category Temperature Range	-40 to +105°C	
Rated Voltage Range	10 to 450V	
Rated Capacitance Range	22 to 330µF	
Capacitance Tolerance	±20% at 120Hz, 20°C	
Leakage Current ※	Rated Voltage(V)	10 to 100
	—	160 to 450
Tangent of loss angle (tan δ)	After 2 minutes' application of rated voltage at 20°C, leakage current is not more than 0.01CV (µA).	
	After 1 minute's application of rated voltage at 20°C, CV ≤ 1000 : I= 0.1CV+40 (µA) or less. CV > 1000 : I= 0.04CV+100 (µA) or less.	
Stability at Low Temperature	Measurement frequency : 120Hz at 20°C	
	Rated voltage (V)	10 16 25 35 50 63 100 160 to 450
Endurance	The specifications listed below shall be met when the capacitors are restored to 20°C after D.C. bias plus rated ripple current is applied for 10000 hours at 105°C, the peak voltage shall not exceed the rated voltage.	
	The specifications listed below shall be met when the capacitors are restored to 20°C after D.C. bias plus rated ripple current is applied for 20000 hours (15000 hours for φ8×11.5L, φ10×12.5L) at 105°C, the peak voltage shall not exceed the rated voltage.	
Shelf Life	After storing the capacitors under no load at 105°C for 1000 hours and then performing voltage treatment based on JIS C 5101-4 clause 4.1 at 20°C, they shall meet the specified values for the endurance characteristics listed above.	
	Printed with white color letter on dark brown sleeve.	

Radial Lead Type

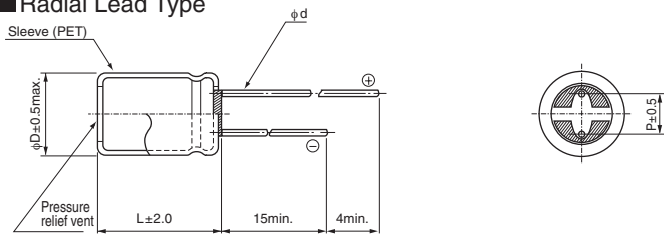

	(mm)				
φD	8	10	12.5	16	18
P	3.5	5.0	5.0	7.5	7.5
φd	0.6	0.6	0.6	0.8	0.8

● Please refer to the Guidelines for Aluminum Electrolytic Capacitors for end seal configuration information.

● Frequency coefficient of rated ripple current (10~100V)

Cap.(µF)	Frequency			
22µF	120Hz	1kHz	10kHz	100kHz
47 to 330µF	0.55	0.75	0.90	1.00
	0.70	0.85	0.95	1.00

● Frequency coefficient of rated ripple current (160~450V)

Cap.(µF)	Frequency			
2.2 to 5.6µF	120Hz	1kHz	10kHz	100kHz or more
6.8 to 18µF	1.00	1.60	1.80	2.00
22 to 68µF	1.00	1.50	1.70	1.90
	1.00	1.40	1.60	1.80

※ I : Leakage Current (µA), C : Rated Capacitance (µF), V : Rated Voltage (V)

Type numbering system (Example : 400V 6.8µF)

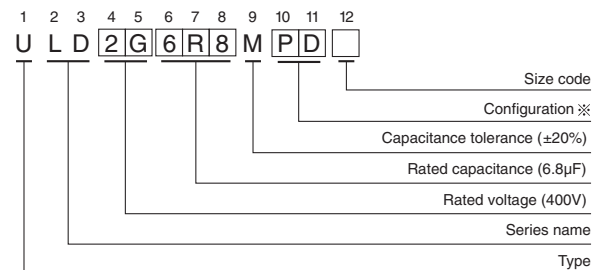

※ Configuration

φ D	Pb-free leadwire Pb-free PET sleeve
8 · 10	PD
12.5 to 18	HD

● Dimension table in next page.

ULD

■ Dimensions

Rated Voltage (V) (code)	Rated Capacitance (μ F)	Case Size ϕ D×L (mm)	tan δ	Leakage Current (μ A)		Rated Ripple (mArms)		Part Number
				at 20°C after 1 minute	at 20°C after 2 minutes	105°C/ 100kHz	105°C/ 120Hz	
10 (1A)	330	8×11.5	0.45	—	33	330	—	ULD1A331MPD
16 (1C)	220	8×11.5	0.35	—	35.2	330	—	ULD1C221MPD
	270	8×11.5	0.35	—	43.2	330	—	ULD1C271MPD
25 (1E)	150	8×11.5	0.30	—	37.5	330	—	ULD1E151MPD
35 (1V)	100	8×11.5	0.22	—	35	330	—	ULD1V101MPD
50 (1H)	100	8×11.5	0.19	—	50	270	—	ULD1H101MPD
63 (1J)	47	8×11.5	0.17	—	29.61	240	—	ULD1J470MPD
100 (2A)	22	8×11.5	0.15	—	22	230	—	ULD2A220MPD
160 (2C)	15	8×11.5	0.24	196	—	—	92	ULD2C150MPD
	22	10×12.5	0.24	240.8	—	—	121	ULD2C220MPD
	33	10×16	0.24	311.2	—	—	158	ULD2C330MPD

Rated Voltage (V) (code)	Rated Capacitance (μ F)	Case Size ϕ D×L (mm)	tan δ	Leakage Current (μ A) (at 20°C after 1 minute)	Rated Ripple (mArms) (105°C/120Hz)	Part Number
200 (2D)	10	8×11.5	0.24	180	80	ULD2D100MPD
	18	10×12.5	0.24	244	113	ULD2D180MPD
	27	10×16	0.24	316	149	ULD2D270MPD
250 (2E)	5.6	8×11.5	0.24	156	62	※ULD2E5R6MPD
	6.8	8×11.5	0.24	168	68	※ULD2E6R8MPD
	10	10×12.5	0.24	200	90	※ULD2E100MPD
	12	10×12.5	0.24	220	97	※ULD2E120MPD
	18	10×16	0.24	280	129	※ULD2E180MPD
400 (2G)	2.2	8×11.5	0.24	128	40	ULD2G2R2MPD
	2.7	8×11.5	0.24	143.2	43	ULD2G2R7MPD
	3.3	8×11.5	0.24	152.8	47	ULD2G3R3MPD
	3.9	10×12.5	0.24	162.4	57	ULD2G3R9MPD
	4.7	10×12.5	0.24	175.2	61	ULD2G4R7MPD
	5.6	10×12.5	0.24	189.6	64	ULD2G5R6MPD
	6.8	10×16	0.24	208.8	85	ULD2G6R8MPD
	8.2	10×16	0.24	231.2	88	ULD2G8R2MPD
450 (2W)	5.6	10×16	0.24	200.8	58	ULD2W5R6MPD
	6.8	10×16	0.24	222.4	62	ULD2W6R8MPD
	8.2	10×20	0.24	247.6	88	ULD2W8R2MPD
	10	10×20	0.24	280	92	ULD2W100MPD
	15	12.5×20	0.24	370	140	ULD2W150MHD
	22	12.5×25	0.24	496	240	ULD2W220MHD
	22	16×20	0.24	496	292	ULD2W220MHD6
	27	16×20	0.24	586	305	ULD2W270MHD
	33	16×25	0.24	694	392	ULD2W330MHD
	33	18×20	0.24	694	312	ULD2W330MHD6
	47	18×25	0.24	946	480	ULD2W470MHD
68	18×30.5	0.24	1324	520	ULD2W680MHD	

For cut leads, formed leads or taped parts, please add the appropriate code after the size code (12th digit).
If there is no size code in the part number, please add size code "1" and then add the appropriate code.

- For formed lead or taped product specifications and minimum order quantity, please refer to the Guidelines for Aluminum Electrolytic Capacitors.

ALUMINUM ELECTROLYTIC CAPACITORS



Miniature Sized, High Ripple Current,
High Reliability

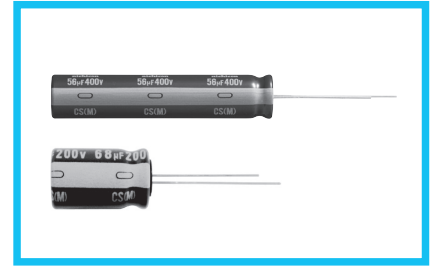
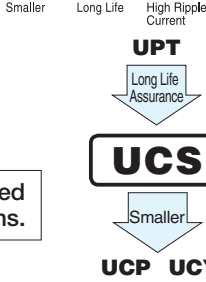

- High ripple current and Long Life product withstanding load life of 8000 to 10000 hours at +105°C.
- Suited for power supply and ballast application.
- Compliant to the RoHS directive (2011/65/EU, (EU)2015/863).

Valued marked with an ※ in the dimension table are scheduled to be discontinued and are not recommended for new designs.

Specifications

Item	Performance Characteristics																						
Category Temperature Range	-40 to +105°C																						
Rated Voltage Range	160 to 450V																						
Rated Capacitance Range	6.8 to 330μF																						
Capacitance Tolerance	±20% at 120Hz, 20°C																						
Leakage Current ※	After 1 minute's application of rated voltage at 20°C, leakage current is not more than 0.04CV+100 (μA)																						
Tangent of loss angle (tan δ)	Measurement frequency : 120Hz at 20°C																						
	<table border="1"> <tr> <td>Rated voltage (V)</td> <td>160</td> <td>200</td> <td>250</td> <td>350</td> <td>400</td> <td>450</td> </tr> <tr> <td>tan δ (max.)</td> <td>0.20</td> <td>0.20</td> <td>0.20</td> <td>0.24</td> <td>0.24</td> <td>0.24</td> </tr> </table>	Rated voltage (V)	160	200	250	350	400	450	tan δ (max.)	0.20	0.20	0.20	0.24	0.24	0.24								
Rated voltage (V)	160	200	250	350	400	450																	
tan δ (max.)	0.20	0.20	0.20	0.24	0.24	0.24																	
Stability at Low Temperature	Measurement frequency : 120Hz																						
	<table border="1"> <tr> <td rowspan="2">Impedance ratio (max.)</td> <td>Rated voltage (V)</td> <td>160</td> <td>200</td> <td>250</td> <td>350</td> <td>400</td> <td>450</td> </tr> <tr> <td>Z(-25°C) / Z(+20°C)</td> <td>3</td> <td>3</td> <td>3</td> <td>5</td> <td>5</td> <td>6</td> </tr> <tr> <td></td> <td>Z(-40°C) / Z(+20°C)</td> <td>6</td> <td>6</td> <td>6</td> <td>6</td> <td>6</td> <td>-</td> </tr> </table>	Impedance ratio (max.)	Rated voltage (V)	160	200	250	350	400	450	Z(-25°C) / Z(+20°C)	3	3	3	5	5	6		Z(-40°C) / Z(+20°C)	6	6	6	6	6
Impedance ratio (max.)	Rated voltage (V)		160	200	250	350	400	450															
	Z(-25°C) / Z(+20°C)	3	3	3	5	5	6																
	Z(-40°C) / Z(+20°C)	6	6	6	6	6	-																
Endurance	<p>The specifications listed at right shall be met when the capacitors are restored to 20°C after D.C. bias plus rated ripple current is applied for 10000 hours (8000 hours for φD × L=10 × 16, 10 × 20) at 105°C, the peak voltage shall not exceed the rated voltage.</p> <table border="1"> <tr> <td>Capacitance change</td> <td>Within ±20% of the initial capacitance value</td> </tr> <tr> <td>tan δ</td> <td>200% or less than the initial specified value</td> </tr> <tr> <td>Leakage current</td> <td>Less than or equal to the initial specified value</td> </tr> </table>	Capacitance change	Within ±20% of the initial capacitance value	tan δ	200% or less than the initial specified value	Leakage current	Less than or equal to the initial specified value																
Capacitance change	Within ±20% of the initial capacitance value																						
tan δ	200% or less than the initial specified value																						
Leakage current	Less than or equal to the initial specified value																						
Shelf Life	After storing the capacitors under no load at 105°C for 1000 hours and then performing voltage treatment based on JIS C 5101-4 clause 4.1 at 20°C, they shall meet the specified values for the endurance characteristics listed above.																						
Marking	Printed with white color letter on dark brown sleeve.																						

※ I : Leakage Current (μA), C : Rated Capacitance (μF), V : Rated Voltage (V)

Radial Lead Type

- The 12th digit of the part number is 9 or none.

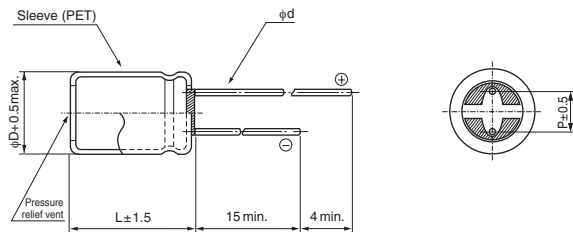

Type numbering system (Example : 250V 100μF)

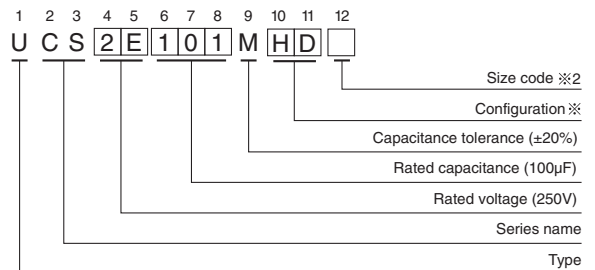

※ Configuration

Size code ※2	Blank, 6	9 (Not recommended)
φ D	Pb-free leadwire Pb-free PET sleeve	Pb-free leadwire Pb-free PET sleeve
10	PD	ND
12.5 to 18	HD	NY

Pencil - shaped Type

- 9 in the 12th digit of the part number.

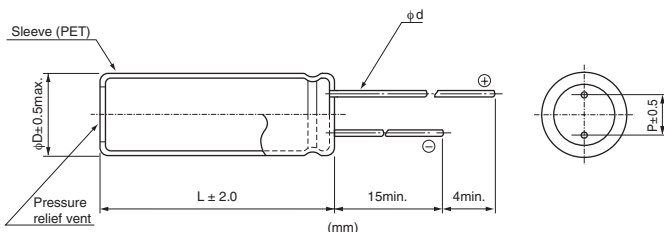

φD	10	12.5	16	18
P	5.0	5.0	7.5	7.5
φd	0.6	0.6	0.8	0.8

- Frequency coefficient of rated ripple current

Frequency	50Hz	120Hz	1kHz	10kHz	100kHz or more
Coefficient	0.40	0.50	0.80	0.90	1.00

• Please refer to the Guidelines for Aluminum Electrolytic Capacitors for end seal configuration information.

• Dimension table in next page.

UCS

■ Dimensions

Rated Voltage (V) (code)	Rated Capacitance (μF)	Case Size φD×L (mm)	tan δ	Leakage Current (μA) (at 20°C after 1 minute)	Rated Ripple (mArms) (105°C/100kHz)	Part Number
160 (2C)	10	10×16	0.20	164	320	UCS2C100MPD
	22	10×20	0.20	240.8	500	UCS2C220MPD
	33	10×20	0.20	311.2	650	UCS2C330MPD
	47	10×20	0.20	400.8	750	UCS2C470MPD
	68	12.5×20	0.20	535.2	1180	UCS2C680MHD
	82	12.5×20	0.20	624.8	1275	UCS2C820MHD
	100	12.5×25	0.20	740	1420	UCS2C101MHD
	100	16×20	0.20	740	1420	UCS2C101MHD6
	150	16×20	0.20	1060	1890	UCS2C151MHD
	220	16×25	0.20	1508	2370	UCS2C221MHD
	330	18×30.5	0.20	2212	3130	UCS2C331MHD
200 (2D)	10	10×16	0.20	180	320	UCS2D100MPD
	22	10×20	0.20	276	500	UCS2D220MPD
	33	10×20	0.20	364	650	UCS2D330MPD
	47	12.5×20	0.20	476	980	UCS2D470MHD
	68	12.5×20	0.20	644	1300	UCS2D680MHD
	82	16×20	0.20	756	1380	UCS2D820MHD
	100	16×20	0.20	900	1420	UCS2D101MHD
	100	10×40	0.20	900	1260	※UCS2D101MND9
	120	10×40	0.20	1060	1360	※UCS2D121MND9
	150	16×25	0.20	1300	1890	UCS2D151MHD
	150	10×50	0.20	1300	1660	※UCS2D151MND9
	220	18×25	0.20	1860	2365	UCS2D221MHD
	270	12.5×50	0.20	2260	2530	※UCS2D271MNY9
	330	18×35.5	0.20	2740	3220	UCS2D331MHD
250 (2E)	10	10×20	0.20	200	350	UCS2E100MPD
	22	10×20	0.20	320	500	UCS2E220MPD
	33	12.5×20	0.20	430	800	UCS2E330MHD
	47	12.5×20	0.20	570	980	UCS2E470MHD
	68	16×20	0.20	780	1300	UCS2E680MHD
	82	16×20	0.20	920	1380	UCS2E820MHD
	82	10×40	0.20	920	1220	※UCS2E820MND9
	100	16×25	0.20	1100	1530	UCS2E101MHD
	100	10×50	0.20	1100	1360	※UCS2E101MND9
	150	18×25	0.20	1600	1940	UCS2E151MHD
	180	12.5×50	0.20	1900	2070	※UCS2E181MNY9
	220	18×30.5	0.20	2300	3130	UCS2E221MHD
350 (2V)	6.8	10×16	0.24	195.2	280	UCS2V6R8MPD
	10	10×20	0.24	240	350	UCS2V100MPD
	22	12.5×20	0.24	408	650	UCS2V220MHD
	33	16×20	0.24	562	900	UCS2V330MHD
	47	16×20	0.24	758	1080	UCS2V470MHD
	68	16×25	0.24	1052	1400	UCS2V680MHD
	68	18×20	0.24	1052	1375	UCS2V680MHD6
	82	18×25	0.24	1248	1530	UCS2V820MHD
	100	18×25	0.24	1500	1575	UCS2V101MHD

For cut leads, formed leads or taped parts, please add the appropriate code after the size code (12th digit).
If there is no size code in the part number, please add size code "1" and then add the appropriate code.

UCS

■ Dimensions

Rated Voltage (V) (code)	Rated Capacitance (μF)	Case Size φD×L (mm)	tan δ	Leakage Current (μA) (at 20°C after 1 minute)	Rated Ripple (mArms) (105°C/100kHz)	Part Number
400 (2G)	6.8	10×16	0.24	208.8	280	UCS2G6R8MPD
	10	10×20	0.24	260	350	UCS2G100MPD
	15	12.5×20	0.24	340	550	UCS2G150MHD
	22	12.5×20	0.24	452	760	UCS2G220MHD
	33	16×20	0.24	628	900	UCS2G330MHD
	39	10×40	0.24	724	800	※UCS2G390MND9
	47	16×25	0.24	852	1180	UCS2G470MHD
	47	18×20	0.24	852	1180	UCS2G470MHD6
	56	10×50	0.24	996	1040	※UCS2G560MND9
	68	18×25	0.24	1188	1470	UCS2G680MHD
	82	18×25	0.24	1412	1525	UCS2G820MHD
82	12.5×50	0.24	1412	1400	※UCS2G820MNY9	
450 (2W)	6.8	10×20	0.24	222.4	280	UCS2W6R8MPD
	10	12.5×20	0.24	280	450	UCS2W100MHD
	15	12.5×25	0.24	370	600	UCS2W150MHD
	22	16×20	0.24	496	730	UCS2W220MHD
	27	10×40	0.24	586	580	※UCS2W270MND9
	33	16×25	0.24	694	980	UCS2W330MHD
	33	18×20	0.24	694	980	UCS2W330MHD6
	33	10×40	0.24	694	720	※UCS2W330MND9
	39	10×50	0.24	802	820	※UCS2W390MND9
	47	18×25	0.24	946	1200	UCS2W470MHD
	68	18×30.5	0.24	1324	1575	UCS2W680MHD
	68	12.5×50	0.24	1324	1340	※UCS2W680MNY9

For cut leads, formed leads or taped parts, please add the appropriate code after the size code (12th digit).
If there is no size code in the part number, please add size code "1" and then add the appropriate code.

- For formed lead or taped product specifications and minimum order quantity, please refer to the Guidelines for Aluminum Electrolytic Capacitors.

UCY Miniature Sized, High Ripple Current,
High Reliability



- High ripple current and Long Life product withstanding load life of 10000 to 12000 hours at +105°C.
- Suited for power supply and ballast application.
- Compliant to the RoHS directive (2011/65/EU, (EU) 2015/863).
- AEC-Q200 Qualified. Please contact us for details.

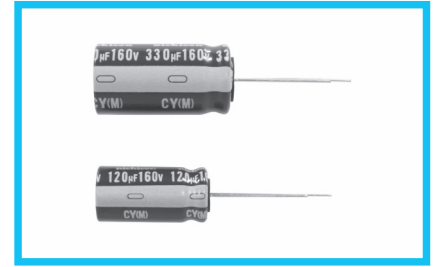
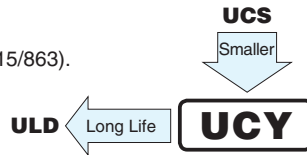

Specifications

Item	Performance Characteristics																												
Category Temperature Range	-40 to +105°C																												
Rated Voltage Range	160 to 500V																												
Rated Capacitance Range	6.8 to 680µF																												
Capacitance Tolerance	±20% at 120Hz, 20°C																												
Leakage Current ※	After 1 minute's application of rated voltage at 20°C, leakage current is not more than 0.04CV+100 (µA)																												
Tangent of loss angle (tan δ)	Measurement frequency : 120Hz at 20°C																												
	<table border="1"> <thead> <tr> <th>Rated voltage (V)</th> <th>160</th> <th>200</th> <th>250</th> <th>350</th> <th>400</th> <th>420</th> <th>450</th> <th>500</th> </tr> </thead> <tbody> <tr> <td>tan δ (max.)</td> <td>0.20</td> <td>0.20</td> <td>0.20</td> <td>0.24</td> <td>0.24</td> <td>0.24</td> <td>0.24</td> <td>0.24</td> </tr> </tbody> </table>	Rated voltage (V)	160	200	250	350	400	420	450	500	tan δ (max.)	0.20	0.20	0.20	0.24	0.24	0.24	0.24	0.24										
Rated voltage (V)	160	200	250	350	400	420	450	500																					
tan δ (max.)	0.20	0.20	0.20	0.24	0.24	0.24	0.24	0.24																					
Stability at Low Temperature	Measurement frequency : 120Hz																												
	<table border="1"> <thead> <tr> <th colspan="2">Rated voltage (V)</th> <th>160</th> <th>200</th> <th>250</th> <th>350</th> <th>400</th> <th>420</th> <th>450</th> <th>500</th> </tr> </thead> <tbody> <tr> <td rowspan="2">Impedance ratio (max.)</td> <td>Z(-25°C) / Z(+20°C)</td> <td>3</td> <td>3</td> <td>3</td> <td>5</td> <td>5</td> <td>6</td> <td>6</td> <td>6</td> </tr> <tr> <td>Z(-40°C) / Z(+20°C)</td> <td>6</td> <td>6</td> <td>6</td> <td>6</td> <td>6</td> <td>-</td> <td>-</td> <td>-</td> </tr> </tbody> </table>	Rated voltage (V)		160	200	250	350	400	420	450	500	Impedance ratio (max.)	Z(-25°C) / Z(+20°C)	3	3	3	5	5	6	6	6	Z(-40°C) / Z(+20°C)	6	6	6	6	6	-	-
Rated voltage (V)		160	200	250	350	400	420	450	500																				
Impedance ratio (max.)	Z(-25°C) / Z(+20°C)	3	3	3	5	5	6	6	6																				
	Z(-40°C) / Z(+20°C)	6	6	6	6	6	-	-	-																				
Endurance	<p>The specifications listed at right shall be met when the capacitors are restored to 20°C after D.C. bias plus rated ripple current is applied for 12000 hours (10000 hours for 20L or less, 500V) at 105°C, the peak voltage shall not exceed the rated voltage.</p> <table border="1"> <tbody> <tr> <td>Capacitance change</td> <td>Within ±20% of the initial capacitance value</td> </tr> <tr> <td>tan δ</td> <td>200% or less than the initial specified value</td> </tr> <tr> <td>Leakage current</td> <td>Less than or equal to the initial specified value</td> </tr> </tbody> </table>	Capacitance change	Within ±20% of the initial capacitance value	tan δ	200% or less than the initial specified value	Leakage current	Less than or equal to the initial specified value																						
Capacitance change	Within ±20% of the initial capacitance value																												
tan δ	200% or less than the initial specified value																												
Leakage current	Less than or equal to the initial specified value																												
Shelf Life	After storing the capacitors under no load at 105°C for 1000 hours and then performing voltage treatment based on JIS C 5101-4 clause 4.1 at 20°C, they shall meet the specified values for the endurance characteristics listed above.																												
Marking	Printed with white color letter on dark brown sleeve.																												

※ I : Leakage Current (µA), C : Rated Capacitance (µF), V : Rated Voltage (V)

Radial Lead Type

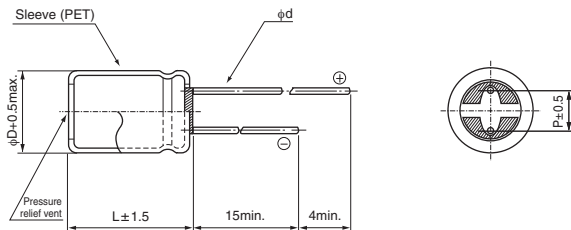

	(mm)			
φD	10	12.5	16	18
P	5.0	5.0	7.5	7.5
φd	0.6	0.6 ^{*)}	0.8	0.8

※ In case L > 25 for the φ12.5 dia. unit, lead dia. φd = 0.8mm.

- Please refer to the Guidelines for Aluminum Electrolytic Capacitors for end seal configuration information.

Frequency coefficient of rated ripple current

Frequency	50Hz	120Hz	1kHz	10kHz	100kHz or more
Coefficient	0.80	1.00	1.60	1.80	2.00

● Dimension table in next page.

Type numbering system (Example : 250V 100µF)

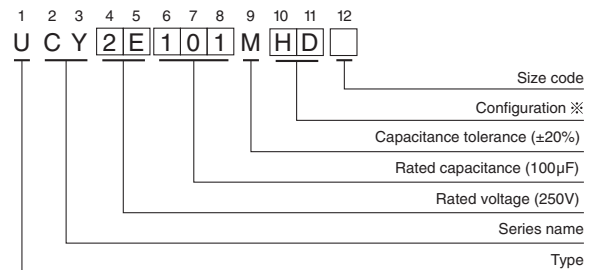

※ Configuration

φ D	Pb-free leadwire Pb-free PET sleeve
10	PD
12.5 to 18	HD



■ Dimensions

Rated Voltage (V) (code)	Rated Capacitance (μF)	Case Size φD×L (mm)	tan δ	Leakage Current (μA) (at 20°C after 1 minute)	Rated Ripple (mArms) (105°C/120Hz)	Part Number
160 (2C)	33	10×16	0.20	311.2	260	UCY2C330MPD
	39	10×16	0.20	349.6	295	UCY2C390MPD
	47	10×20	0.20	400.8	375	UCY2C470MPD
	56	10×20	0.20	458.4	380	UCY2C560MPD
	68	10×25	0.20	535.2	455	UCY2C680MPD
	68	12.5×20	0.20	535.2	590	UCY2C680MHD3
	82	10×30.5	0.20	624.8	534	UCY2C820MPD
	82	10×25	0.20	624.8	455	UCY2C820MPD9
	82	12.5×20	0.20	624.8	640	UCY2C820MHD3
	100	12.5×20	0.20	740	645	UCY2C101MHD
	120	12.5×25	0.20	868	760	UCY2C121MHD
	150	12.5×30.5	0.20	1060	905	UCY2C151MHD
	150	12.5×25	0.20	1060	760	UCY2C151MHD9
	150	16×20	0.20	1060	945	UCY2C151MHD3
	180	16×20	0.20	1252	1000	UCY2C181MHD
	180	12.5×30.5	0.20	1252	905	UCY2C181MHD9
	180	12.5×35.5	0.20	1252	1050	UCY2C181MHD6
	220	12.5×40	0.20	1508	1200	UCY2C221MHD
	220	12.5×35.5	0.20	1508	1050	UCY2C221MHD9
	220	16×25	0.20	1508	1185	UCY2C221MHD3
	220	18×20	0.20	1508	1105	UCY2C221MHD6
	270	18×25	0.20	1828	1235	UCY2C271MHD
	270	12.5×40	0.20	1828	1300	UCY2C271MHD6
	330	16×30.5	0.20	2212	1510	UCY2C331MHD
	330	18×25	0.20	2212	1445	UCY2C331MHD6
	390	16×40	0.20	2596	1730	UCY2C391MHD
	390	16×35.5	0.20	2596	1510	UCY2C391MHD9
	390	18×30.5	0.20	2596	1695	UCY2C391MHD6
	470	18×35.5	0.20	3108	1920	UCY2C471MHD
	470	16×40	0.20	3108	1730	UCY2C471MHD6
560	18×40	0.20	3684	2130	UCY2C561MHD	
680	18×46	0.20	4452	2300	UCY2C681MHD	
200 (2D)	22	10×16	0.20	276	225	UCY2D220MPD
	27	10×16	0.20	316	235	UCY2D270MPD
	33	10×20	0.20	364	305	UCY2D330MPD
	39	10×20	0.20	412	325	UCY2D390MPD
	47	10×20	0.20	476	360	UCY2D470MPD
	47	12.5×20	0.20	476	490	UCY2D470MHD3
	56	10×25	0.20	548	415	UCY2D560MPD
	68	10×30.5	0.20	644	485	UCY2D680MPD
	68	12.5×20	0.20	644	650	UCY2D680MHD3
	82	12.5×25	0.20	756	645	UCY2D820MHD
	82	12.5×20	0.20	756	645	UCY2D820MHD9
	82	16×20	0.20	756	690	UCY2D820MHD3
	100	12.5×25	0.20	900	695	UCY2D101MHD
	100	16×20	0.20	900	710	UCY2D101MHD3

For cut leads, formed leads or taped parts, please add the appropriate code after the size code (12th digit).
 If there is no size code in the part number, please add size code "1" and then add the appropriate code.

UCY

■ Dimensions

Rated Voltage (V) (code)	Rated Capacitance (μF)	Case Size φD×L (mm)	tan δ	Leakage Current (μA) (at 20°C after 1 minute)	Rated Ripple (mArms) (105°C/120Hz)	Part Number
200 (2D)	120	16×20	0.20	1060	775	UCY2D121MHD
	120	12.5×30.5	0.20	1060	810	UCY2D121MHD6
	150	12.5×35.5	0.20	1300	965	UCY2D151MHD
	150	16×25	0.20	1300	945	UCY2D151MHD3
	150	18×20	0.20	1300	910	UCY2D151MHD6
	180	12.5×40	0.20	1540	1090	UCY2D181MHD
	180	16×25	0.20	1540	1035	UCY2D181MHD6
	180	18×20	0.20	1540	910	UCY2D181MHD3
	220	16×30.5	0.20	1860	1230	UCY2D221MHD
	220	12.5×40	0.20	1860	1090	UCY2D221MHD6
	220	18×25	0.20	1860	1185	UCY2D221MHD3
	270	16×35.5	0.20	2260	1400	UCY2D271MHD
	270	18×30.5	0.20	2260	1410	UCY2D271MHD6
	330	16×40	0.20	2740	1595	UCY2D331MHD
	330	18×30.5	0.20	2740	1560	UCY2D331MHD6
	390	18×40	0.20	3220	1780	UCY2D391MHD
	390	18×35.5	0.20	3220	1690	UCY2D391MHD9
	470	18×40	0.20	3860	1850	UCY2D471MHD
470	18×46	0.20	3860	1900	UCY2D471MHD6	
250 (2E)	22	10×16	0.20	320	225	UCY2E220MPD
	27	10×20	0.20	370	255	UCY2E270MPD
	33	10×20	0.20	430	305	UCY2E330MPD
	33	12.5×20	0.20	430	400	UCY2E330MHD3
	39	10×25	0.20	490	345	UCY2E390MPD
	47	10×30.5	0.20	570	405	UCY2E470MPD
	47	10×25	0.20	570	345	UCY2E470MPD9
	47	12.5×20	0.20	570	490	UCY2E470MHD3
	56	12.5×20	0.20	660	515	UCY2E560MHD
	68	12.5×25	0.20	780	615	UCY2E680MHD
	68	16×20	0.20	780	650	UCY2E680MHD3
	82	12.5×30.5	0.20	920	715	UCY2E820MHD
	82	12.5×25	0.20	920	615	UCY2E820MHD9
	82	16×20	0.20	920	690	UCY2E820MHD3
	100	16×20	0.20	1100	715	UCY2E101MHD
	100	12.5×35.5	0.20	1100	785	UCY2E101MHD6
	120	16×25	0.20	1300	845	UCY2E121MHD
	120	12.5×35.5	0.20	1300	785	UCY2E121MHD9
	120	12.5×40	0.20	1300	890	UCY2E121MHD3
	120	18×20	0.20	1300	815	UCY2E121MHD6
	150	18×25	0.20	1600	970	UCY2E151MHD
	150	12.5×40	0.20	1600	990	UCY2E151MHD6
	180	16×30.5	0.20	1900	1110	UCY2E181MHD
	180	18×25	0.20	1900	1050	UCY2E181MHD6
	220	16×40	0.20	2300	1295	UCY2E221MHD
	220	16×35.5	0.20	2300	1220	UCY2E221MHD9
	220	18×30.5	0.20	2300	1160	UCY2E221MHD3

For cut leads, formed leads or taped parts, please add the appropriate code after the size code (12th digit).
If there is no size code in the part number, please add size code "1" and then add the appropriate code.

UCY

■ Dimensions

Rated Voltage (V) (code)	Rated Capacitance (μF)	Case Size φD×L (mm)	tan δ	Leakage Current (μA) (at 20°C after 1 minute)	Rated Ripple (mArms) (105°C/120Hz)	Part Number
250 (2E)	270	18×35.5	0.20	2800	1450	UCY2E271MHD
	270	16×40	0.20	2800	1350	UCY2E271MHD6
	330	18×46	0.20	3400	1600	UCY2E331MHD
	330	18×40	0.20	3400	1530	UCY2E331MHD9
350 (2V)	12	10×16	0.24	268	160	UCY2V120MPD
	15	10×20	0.24	310	180	UCY2V150MPD
	18	10×20	0.24	352	215	UCY2V180MPD
	22	10×25	0.24	408	255	UCY2V220MPD
	22	10×20	0.24	408	215	UCY2V220MPD9
	22	12.5×20	0.24	408	325	UCY2V220MHD3
	27	10×30.5	0.24	478	305	UCY2V270MPD
	27	10×25	0.24	478	255	UCY2V270MPD9
	33	12.5×20	0.24	562	380	UCY2V330MHD
	33	16×20	0.24	562	450	UCY2V330MHD3
	39	12.5×25	0.24	646	455	UCY2V390MHD
	47	12.5×25	0.24	758	510	UCY2V470MHD
	47	16×20	0.24	758	540	UCY2V470MHD3
	56	12.5×30.5	0.24	884	590	UCY2V560MHD
	56	16×20	0.24	884	565	UCY2V560MHD6
	68	12.5×35.5	0.24	1052	695	UCY2V680MHD
	68	16×25	0.24	1052	700	UCY2V680MHD3
	68	18×20	0.24	1052	690	UCY2V680MHD6
	82	16×30.5	0.24	1248	740	UCY2V820MHD
	82	12.5×40	0.24	1248	785	UCY2V820MHD6
	82	16×25	0.24	1248	700	UCY2V820MHD9
	82	18×25	0.24	1248	765	UCY2V820MHD3
	100	16×30.5	0.24	1500	825	UCY2V101MHD
	100	18×25	0.24	1500	790	UCY2V101MHD3
	120	16×35.5	0.24	1780	925	UCY2V121MHD
	120	18×30.5	0.24	1780	940	UCY2V121MHD6
	150	18×35.5	0.24	2200	1080	UCY2V151MHD
	150	16×40	0.24	2200	1000	UCY2V151MHD6
180	18×40	0.24	2620	1205	UCY2V181MHD	
220	18×46	0.24	3180	1300	UCY2V221MHD	
400 (2G)	6.8	10×16	0.24	208.8	140	UCY2G6R8MPD
	10	10×16	0.24	260	150	UCY2G100MPD
	12	10×20	0.24	292	175	UCY2G120MPD
	15	10×20	0.24	340	180	UCY2G150MPD
	18	10×25	0.24	388	235	UCY2G180MPD
	22	10×30.5	0.24	452	275	UCY2G220MPD
	27	12.5×20	0.24	532	360	UCY2G270MHD
	33	12.5×25	0.24	628	385	UCY2G330MHD
	33	16×20	0.24	628	450	UCY2G330MHD3
	39	12.5×30.5	0.24	724	465	UCY2G390MHD
	39	12.5×25	0.24	724	385	UCY2G390MHD9
	47	16×20	0.24	852	520	UCY2G470MHD

For cut leads, formed leads or taped parts, please add the appropriate code after the size code (12th digit).
If there is no size code in the part number, please add size code "1" and then add the appropriate code.

UCY

■ Dimensions

Rated Voltage (V) (code)	Rated Capacitance (μF)	Case Size φD×L (mm)	tan δ	Leakage Current (μA) (at 20°C after 1 minute)	Rated Ripple (mArms) (105°C/120Hz)	Part Number
400 (2G)	47	12.5×30.5	0.24	852	510	UCY2G470MHD6
	47	18×20	0.24	852	590	UCY2G470MHD3
	56	12.5×35.5	0.24	996	630	UCY2G560MHD
	56	16×25	0.24	996	585	UCY2G560MHD6
	56	18×20	0.24	996	600	UCY2G560MHD3
	68	12.5×40	0.24	1188	720	UCY2G680MHD
	68	16×25	0.24	1188	640	UCY2G680MHD9
	68	18×25	0.24	1188	735	UCY2G680MHD3
	82	16×30.5	0.24	1412	805	UCY2G820MHD
	82	18×25	0.24	1412	765	UCY2G820MHD3
	100	16×35.5	0.24	1700	850	UCY2G101MHD
	100	18×30.5	0.24	1700	875	UCY2G101MHD6
	120	18×30.5	0.24	2020	940	UCY2G121MHD
	120	16×40	0.24	2020	950	UCY2G121MHD6
	120	18×35.5	0.24	2020	960	UCY2G121MHD3
	150	18×40	0.24	2500	1030	UCY2G151MHD
180	18×46	0.24	2980	1110	UCY2G181MHD	
420 (W6)	6.8	10×16	0.24	214.24	105	UCYW66R8MPD
	10	10×20	0.24	268	135	UCYW6100MPD
	12	10×20	0.24	301.6	150	UCYW6120MPD
	15	10×25	0.24	352	185	UCYW6150MPD
	18	10×30.5	0.24	402.4	215	UCYW6180MPD
	22	12.5×20	0.24	469.6	285	UCYW6220MHD
	27	12.5×25	0.24	553.6	340	UCYW6270MHD
	33	12.5×30.5	0.24	654.4	400	UCYW6330MHD
	33	16×20	0.24	654.4	385	UCYW6330MHD3
	39	12.5×30.5	0.24	755.2	430	UCYW6390MHD
	47	12.5×35.5	0.24	889.6	505	UCYW6470MHD
	47	16×25	0.24	889.6	500	UCYW6470MHD6
	47	18×20	0.24	889.6	480	UCYW6470MHD3
	56	12.5×40	0.24	1040.8	570	UCYW6560MHD
	68	16×30.5	0.24	1242.4	645	UCYW6680MHD
	68	18×25	0.24	1242.4	615	UCYW6680MHD3
	82	16×35.5	0.24	1477.6	725	UCYW6820MHD
	82	18×30.5	0.24	1477.6	730	UCYW6820MHD6
	100	16×40	0.24	1780	825	UCYW6101MHD
	100	18×35.5	0.24	1780	835	UCYW6101MHD6
120	18×40	0.24	2116	930	UCYW6121MHD	
120	18×46	0.24	2116	945	UCYW6121MHD6	
450 (2W)	6.8	10×16	0.24	222.4	105	UCY2W6R8MPD
	10	10×20	0.24	280	135	UCY2W100MPD
	12	10×20	0.24	316	150	UCY2W120MPD
	15	10×25	0.24	370	185	UCY2W150MPD
	18	10×30.5	0.24	424	215	UCY2W180MPD
	18	12.5×20	0.24	424	255	UCY2W180MHD6
	22	12.5×25	0.24	496	300	UCY2W220MHD

For cut leads, formed leads or taped parts, please add the appropriate code after the size code (12th digit).
If there is no size code in the part number, please add size code "1" and then add the appropriate code.



■ Dimensions

Rated Voltage (V) (code)	Rated Capacitance (μF)	Case Size φD×L (mm)	tan δ	Leakage Current (μA) (at 20°C after 1 minute)	Rated Ripple (mArms) (105°C/120Hz)	Part Number
450 (2W)	27	12.5×25	0.24	586	340	UCY2W270MHD
	33	12.5×30.5	0.24	694	400	UCY2W330MHD
	33	16×20	0.24	694	385	UCY2W330MHD3
	39	12.5×35.5	0.24	802	460	UCY2W390MHD
	39	18×20	0.24	802	440	UCY2W390MHD3
	47	12.5×40	0.24	946	525	UCY2W470MHD
	47	16×25	0.24	946	500	UCY2W470MHD6
	56	16×30.5	0.24	1108	585	UCY2W560MHD
	56	18×25	0.24	1108	560	UCY2W560MHD3
	68	16×35.5	0.24	1324	660	UCY2W680MHD
	82	16×40	0.24	1576	750	UCY2W820MHD
	82	18×30.5	0.24	1576	730	UCY2W820MHD6
	100	18×35.5	0.24	1900	835	UCY2W101MHD
	120	18×40	0.24	2260	930	UCY2W121MHD
120	18×46	0.24	2260	945	UCY2W121MHD6	
500 (2H)	10	12.5×20	0.24	300	160	UCY2H100MHD
	15	12.5×25	0.24	400	220	UCY2H150MHD
	15	16×20	0.24	400	220	UCY2H150MHD3
	18	12.5×30.5	0.24	460	240	UCY2H180MHD
	18	16×20	0.24	460	240	UCY2H180MHD3
	22	12.5×35.5	0.24	540	280	UCY2H220MHD
	22	16×25	0.24	540	280	UCY2H220MHD6
	22	18×20	0.24	540	280	UCY2H220MHD3
	27	12.5×40	0.24	640	310	UCY2H270MHD
	27	16×25	0.24	640	310	UCY2H270MHD6
	33	16×30.5	0.24	760	350	UCY2H330MHD
	33	18×25	0.24	760	350	UCY2H330MHD3
	39	16×35.5	0.24	880	380	UCY2H390MHD
	47	16×40	0.24	1040	440	UCY2H470MHD
	47	18×30.5	0.24	1040	440	UCY2H470MHD6
	56	18×35.5	0.24	1220	480	UCY2H560MHD
68	18×40	0.24	1460	525	UCY2H680MHD	

For cut leads, formed leads or taped parts, please add the appropriate code after the size code (12th digit).
If there is no size code in the part number, please add size code "1" and then add the appropriate code.

- For formed lead or taped product specifications and minimum order quantity, please refer to the Guidelines for Aluminum Electrolytic Capacitors.

ALUMINUM ELECTROLYTIC CAPACITORS

UBT

High Temperature Range, For +125°C Use



- Highly dependable reliability withstanding load life of 2000 to 10000 hours at +125°C.
- Suited for automobile electronics where heavy duty services are indispensable.
- Compliant to the RoHS directive (2011/65/EU,(EU)2015/863).
- AEC-Q200 Qualified. Please contact us for details.

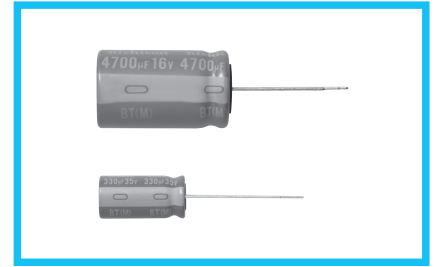
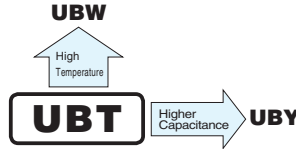

Specifications

Item	Performance Characteristics											
Category Temperature Range	-40 to +125°C (10 to 250V), -25 to +125°C (350 to 450V)											
Rated Voltage Range	10 to 450V											
Rated Capacitance Range	4.7 to 4700μF											
Capacitance Tolerance	±20% at 120Hz, 20°C											
Leakage Current ※	Rated Voltage (V)	10 to 100					160 to 450					
	Leakage current	After 1 minute's application of rated voltage at 20°C, leakage current is not more than 0.03CV (μA).					After 1 minute's application of rated voltage at 20°C, I = 0.04CV+100 (μA) or less.					
Tangent of loss angle (tan δ)	Rated voltage (V)	10	16	25	35	50	63	80	100	160 to 250	350 to 450	120Hz, 20°C
	tan δ (max.)	0.20	0.16	0.14	0.12	0.10	0.10	0.08	0.08	0.20	0.24	
For capacitance of more than 1000μF, add 0.02 for every increase of 1000μF.												
Stability at Low Temperature	120Hz											
	Rated voltage (V)	10	16	25	35	50	63	80	100	160 to 250	350 to 450	
Impedance ratio (max.)	Z(-25°C) / Z(+20°C)	3	2	2	2	2	2	2	2	3	6	
	Z(-40°C) / Z(+20°C)	4	4	4	4	4	4	4	4	6	-	
Endurance	The specifications listed below shall be met when the capacitors are restored to 20°C after D.C. bias plus rated ripple current is applied at 125°C for the condition listed at right. The peak voltage shall not exceed the rated voltage.											
	Rated Voltage	φD(mm)			φ8	φ10	≥φ12.5					
	≤50V				2000hrs.	5000hrs.	10000hrs.					
	63~100V				2000hrs.	3000hrs.	5000hrs.					
≥160V				2000hrs.								
Capacitance change	Within ±30% of the initial capacitance value (10 to 100V) Within ±20% of the initial capacitance value (160 to 450V)											
tan δ	300% or less than the initial specified value (10 to 100V) 200% or less than the initial specified value (160 to 450V)											
Leakage current	Less than or equal to the initial specified value											
Shelf Life	After storing the capacitors under no load at 125°C for 1000 hours and then performing voltage treatment based on JIS C 5101-4 clause 4.1 at 20°C, they shall meet the specified values for the endurance characteristics listed above.											
Marking	Printed with white color letter on blue sleeve.											

※ I : Leakage Current (μA), C : Rated Capacitance (μF), V : Rated Voltage (V)

Radial Lead Type

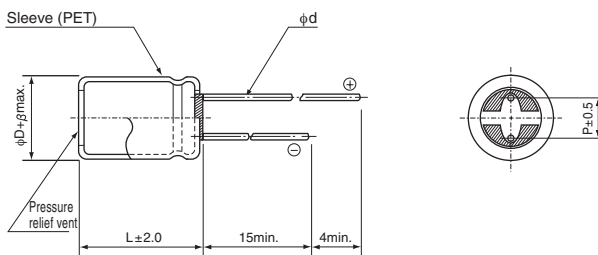

	(mm)				
φD	8	10	12.5	16	18
P	3.5	5.0	5.0	7.5	7.5
φd	0.6	0.6	0.6*	0.8	0.8
β	0.8	0.8	1.0	1.0	1.0

※ In case L > 25 for the φ12.5 dia. unit, lead dia. φd = 0.8mm.

Type numbering system (Example : 10V 220μF)

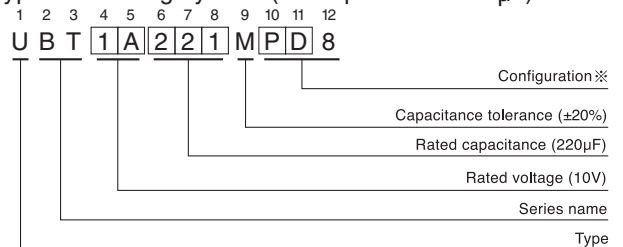

※ Configuration

φ D	Pb-free leadwire Pb-free PET sleeve
8,10	PD
12.5 to 18	HD

Frequency coefficient of rated ripple current

V	CV	Frequency			
		120Hz	300Hz	1kHz	10kHz or more
10 to 100	1000 > CV	0.50	0.64	0.83	1.00
	1000 ≤ CV	0.67	0.79	0.91	1.00

V	Cap. (μF)	Frequency					
		50Hz	120Hz	300Hz	1kHz	10kHz	100kHz or more
160 to 450	4.7 to 33	0.75	1.00	1.25	1.50	1.75	1.80
	47 to 150	0.80	1.00	1.15	1.30	1.40	1.50

- Please refer to the Guidelines for Aluminum Electrolytic Capacitors for end seal configuration information.

● Dimension table in next page.

UBT

■ Dimensions

Rated Voltage (V) (code)	Rated Capacitance (μF)	Case Size φD×L (mm)	tan δ	Leakage Current (μA) (at 20°C after 1 minute)	Impedance (Ω) max. (20°C/100kHz)	Rated Ripple (mA rms) (125°C/100kHz)	Part Number
10 (1A)	220	8×11.5	0.20	66	0.26	340	UBT1A221MPD8
	330	10×12.5	0.20	99	0.15	620	UBT1A331MPD8
	470	10×12.5	0.20	141	0.10	680	UBT1A471MPD8
	1000	10×20	0.20	300	0.057	1100	UBT1A102MPD8
	2200	12.5×25	0.22	660	0.033	1750	UBT1A222MHD8
	3300	16×25	0.24	990	0.024	2300	UBT1A332MHD8
	4700	16×30.5	0.26	1410	0.020	2710	UBT1A472MHD8
16 (1C)	100	8×11.5	0.16	48	0.32	340	UBT1C101MPD8
	220	10×12.5	0.16	105.6	0.15	620	UBT1C221MPD8
	330	10×12.5	0.16	158.4	0.10	680	UBT1C331MPD8
	470	10×16	0.16	225.6	0.075	945	UBT1C471MPD8
	1000	12.5×20	0.16	480	0.042	1490	UBT1C102MHD8
	2200	16×25	0.18	1056	0.024	2300	UBT1C222MHD8
	3300	16×30.5	0.20	1584	0.020	2710	UBT1C332MHD8
25 (1E)	100	8×11.5	0.14	75	0.13	500	UBT1E101MPD8
	220	10×12.5	0.14	165	0.10	680	UBT1E221MPD8
	330	10×16	0.14	247.5	0.075	945	UBT1E331MPD8
	470	10×20	0.14	352.5	0.057	1100	UBT1E471MPD8
	1000	12.5×25	0.14	750	0.033	1750	UBT1E102MHD8
	2200	16×30.5	0.16	1650	0.020	2710	UBT1E222MHD8
	3300	18×30.5	0.18	2475	0.017	3310	UBT1E332MHD8
35 (1V)	100	10×12.5	0.12	105	0.15	620	UBT1V101MPD8
	220	10×16	0.12	231	0.094	790	UBT1V221MPD8
	330	10×20	0.12	346.5	0.075	950	UBT1V331MPD8
	470	12.5×20	0.12	493.5	0.058	1330	UBT1V471MHD8
	1000	16×25	0.12	1050	0.031	2010	UBT1V102MHD8
	2200	18×35.5	0.14	2310	0.025	2790	UBT1V222MHD8
50 (1H)	4.7	8×11.5	0.10	7.05	1.15	85	UBT1H4R7MPD8
	10	8×11.5	0.10	15	0.75	180	UBT1H100MPD8
	22	8×11.5	0.10	33	0.50	250	UBT1H220MPD8
	33	8×11.5	0.10	49.5	0.45	300	UBT1H330MPD8
	47	8×11.5	0.10	70.5	0.35	440	UBT1H470MPD8
	100	10×12.5	0.10	150	0.18	555	UBT1H101MPD8
	220	10×20	0.10	330	0.098	930	UBT1H221MPD8
	330	12.5×20	0.10	495	0.070	1330	UBT1H331MHD8
	470	12.5×25	0.10	705	0.055	1650	UBT1H471MHD8
	1000	16×30.5	0.10	1500	0.031	2430	UBT1H102MHD8
63 (1J)	22	8×11.5	0.10	41.58	2.00	130	UBT1J220MPD8
	33	8×11.5	0.10	62.37	1.50	150	UBT1J330MPD8
	47	10×12.5	0.10	88.83	0.59	530	UBT1J470MPD8
	100	10×16	0.10	189	0.41	690	UBT1J101MPD8
	220	12.5×20	0.10	415.8	0.16	1050	UBT1J221MHD8
	330	12.5×25	0.10	623.7	0.12	1290	UBT1J331MHD8
	470	12.5×30.5	0.10	888.3	0.097	1460	UBT1J471MHD8

UBT

■ Dimensions

Rated Voltage (V) (code)	Rated Capacitance (μF)	Case Size φD×L (mm)	tan δ	Leakage Current (μA) (at 20°C after 1 minute)	Impedance (Ω) max. (20°C/100kHz)	Rated Ripple (mArms) (125°C/100kHz)	Part Number
80 (1K)	22	8×11.5	0.08	52.8	1.50	150	UBT1K220MPD8
	33	10×12.5	0.08	79.2	0.80	480	UBT1K330MPD8
	47	10×12.5	0.08	112.8	0.80	480	UBT1K470MPD8
	100	10×20	0.08	240	0.39	790	UBT1K101MPD8
	220	12.5×25	0.08	528	0.18	1240	UBT1K221MHD8
	330	12.5×30.5	0.08	792	0.16	1390	UBT1K331MHD8
100 (2A)	470	16×25	0.08	1128	0.11	1500	UBT1K471MHD8
	10	8×11.5	0.08	30	1.50	150	UBT2A100MPD8
	22	10×12.5	0.08	66	0.80	480	UBT2A220MPD8
	33	10×12.5	0.08	99	0.80	480	UBT2A330MPD8
	47	10×16	0.08	141	0.55	630	UBT2A470MPD8
	100	12.5×20	0.08	300	0.25	990	UBT2A101MHD8
	220	16×25	0.08	660	0.11	1500	UBT2A221MHD8
330	16×30.5	0.08	990	0.079	1790	UBT2A331MHD8	

Rated Voltage (V) (code)	Rated Capacitance (μF)	Case Size φD×L (mm)	tan δ	Leakage Current (μA) (at 20°C after 1 minute)	Rated Ripple (mArms) (125°C/120Hz)	Part Number
160 (2C)	22	10×20	0.20	240.8	115	UBT2C220MPD8
	33	10×25	0.20	311.2	154	UBT2C330MPD8
	47	12.5×20	0.20	400.8	187	UBT2C470MHD8
	68	12.5×25	0.20	535.2	245	UBT2C680MHD8
	100	16×25	0.20	740	329	UBT2C101MHD8
	150	16×30.5	0.20	1060	434	UBT2C151MHD8
200 (2D)	10	10×20	0.20	180	78	UBT2D100MPD8
	22	10×25	0.20	276	126	UBT2D220MPD8
	33	12.5×20	0.20	364	157	UBT2D330MHD8
	47	12.5×25	0.20	476	204	UBT2D470MHD8
	68	16×20	0.20	644	250	UBT2D680MHD8
250 (2E)	100	16×25	0.20	900	329	UBT2D101MHD8
	10	10×20	0.20	200	78	UBT2E100MPD8
	22	12.5×20	0.20	320	128	UBT2E220MHD8
	33	12.5×25	0.20	430	171	UBT2E330MHD8
350 (2V)	47	16×25	0.20	570	225	UBT2E470MHD8
	68	16×30.5	0.20	780	292	UBT2E680MHD8
	4.7	10×20	0.24	165.8	53	UBT2V4R7MPD8
	10	10×25	0.24	240	85	UBT2V100MPD8
400 (2G)	22	12.5×25	0.24	408	139	UBT2V220MHD8
	33	16×25	0.24	562	189	UBT2V330MHD8
	47	16×30.5	0.24	758	243	UBT2V470MHD8
	4.7	10×20	0.24	175.2	53	UBT2G4R7MPD8
	10	10×25	0.24	260	86	UBT2G100MPD8
450 (2W)	22	12.5×30.5	0.24	452	142	UBT2G220MHD8
	33	16×25	0.24	628	189	UBT2G330MHD8
	47	16×30.5	0.24	852	243	UBT2G470MHD8
	4.7	10×25	0.24	184.6	58	UBT2W4R7MPD8
450 (2W)	10	12.5×20	0.24	280	86	UBT2W100MHD8
	22	16×25	0.24	496	154	UBT2W220MHD8
	33	16×30.5	0.24	694	203	UBT2W330MHD8

• For formed lead or taped product specifications and minimum order quantity, please refer to the Guidelines for Aluminum Electrolytic Capacitors.

UBW

High Temperature Range, For +135°C Use



Long Life

- Highly dependable reliability withstanding load life of 1000 to 3000 hours at +135°C.
- Suited for automobile electronics where heavy duty services are indispensable.
- Compliant to the RoHS directive (2011/65/EU, (EU)2015/863).
- AEC-Q200 Qualified. Please contact us for details.

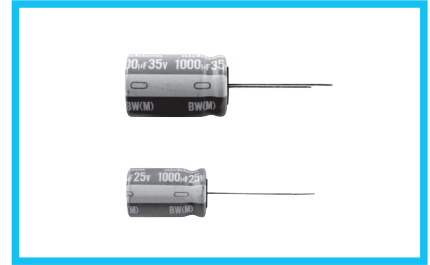
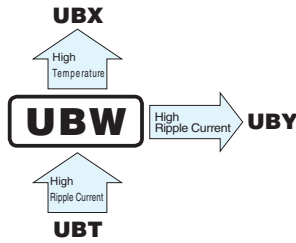

Specifications

Item	Performance Characteristics																																
Category Temperature Range	-55 to +135°C																																
Rated Voltage Range	10 to 100V																																
Rated Capacitance Range	4.7 to 4700µF																																
Capacitance Tolerance	±20% at 120Hz, 20°C																																
Leakage Current ※	After 1 minute's application of rated voltage at 20°C, leakage current is not more than 0.03CV or 4 (µA), whichever is greater.																																
Tangent of loss angle (tan δ)	<table border="1"> <tr> <td>Rated voltage (V)</td> <td>10</td> <td>16</td> <td>25</td> <td>35</td> <td>50</td> <td>63</td> <td>80</td> <td>100</td> <td>120Hz, 20°C</td> </tr> <tr> <td>tan δ (max.)</td> <td>0.20</td> <td>0.16</td> <td>0.14</td> <td>0.12</td> <td>0.10</td> <td>0.10</td> <td>0.08</td> <td>0.08</td> <td></td> </tr> </table> <p>For capacitance of more than 1000µF, add 0.02 for every increase of 1000µF.</p>	Rated voltage (V)	10	16	25	35	50	63	80	100	120Hz, 20°C	tan δ (max.)	0.20	0.16	0.14	0.12	0.10	0.10	0.08	0.08													
Rated voltage (V)	10	16	25	35	50	63	80	100	120Hz, 20°C																								
tan δ (max.)	0.20	0.16	0.14	0.12	0.10	0.10	0.08	0.08																									
Stability at Low Temperature	<table border="1"> <tr> <td colspan="2">Rated voltage (V)</td> <td>10</td> <td>16</td> <td>25</td> <td>35</td> <td>50</td> <td>63</td> <td>80</td> <td>100</td> <td>120Hz</td> </tr> <tr> <td rowspan="2">Impedance ratio (max.)</td> <td>Z(-25°C) / Z(+20°C)</td> <td>3</td> <td>2</td> <td>2</td> <td>2</td> <td>2</td> <td>2</td> <td>2</td> <td>2</td> <td></td> </tr> <tr> <td>Z(-40°C) / Z(+20°C)</td> <td>4</td> <td>4</td> <td>4</td> <td>4</td> <td>4</td> <td>4</td> <td>4</td> <td>4</td> <td></td> </tr> </table>	Rated voltage (V)		10	16	25	35	50	63	80	100	120Hz	Impedance ratio (max.)	Z(-25°C) / Z(+20°C)	3	2	2	2	2	2	2	2		Z(-40°C) / Z(+20°C)	4	4	4	4	4	4	4	4	
Rated voltage (V)		10	16	25	35	50	63	80	100	120Hz																							
Impedance ratio (max.)	Z(-25°C) / Z(+20°C)	3	2	2	2	2	2	2	2																								
	Z(-40°C) / Z(+20°C)	4	4	4	4	4	4	4	4																								
Endurance	<p>The specifications listed below shall be met when the capacitors are restored to 20°C after D.C. bias plus rated ripple current is applied at 135°C for the condition listed at right. The peak voltage shall not exceed the rated voltage.</p> <table border="1"> <tr> <td>Rated Voltage</td> <td>φD(mm)</td> <td>φ8</td> <td>φ10</td> <td>≥φ12.5</td> </tr> <tr> <td>10~100V</td> <td></td> <td>1000hrs.</td> <td>2000hrs.</td> <td>3000hrs.</td> </tr> </table> <table border="1"> <tr> <td>Capacitance change</td> <td>Within ±30% of the initial capacitance value</td> </tr> <tr> <td>tan δ</td> <td>300% or less than the initial specified value</td> </tr> <tr> <td>Leakage current</td> <td>Less than or equal to the initial specified value</td> </tr> </table>	Rated Voltage	φD(mm)	φ8	φ10	≥φ12.5	10~100V		1000hrs.	2000hrs.	3000hrs.	Capacitance change	Within ±30% of the initial capacitance value	tan δ	300% or less than the initial specified value	Leakage current	Less than or equal to the initial specified value																
Rated Voltage	φD(mm)	φ8	φ10	≥φ12.5																													
10~100V		1000hrs.	2000hrs.	3000hrs.																													
Capacitance change	Within ±30% of the initial capacitance value																																
tan δ	300% or less than the initial specified value																																
Leakage current	Less than or equal to the initial specified value																																
Shelf Life	After storing the capacitors under no load at 135°C for 1000 hours and then performing voltage treatment based on JIS C 5101-4 clause 4.1 at 20°C, they shall meet the specified values for the endurance characteristics listed above.																																
Marking	Printed with white color letter on blue sleeve.																																

※ I : Leakage Current (µA), C : Rated Capacitance (µF), V : Rated Voltage (V)

Radial Lead Type

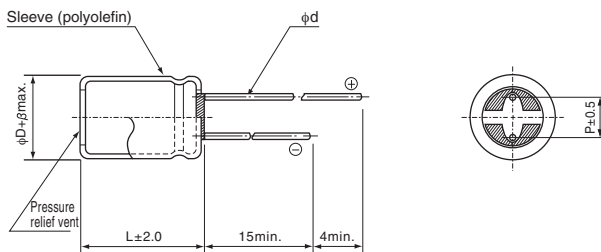

	(mm)			
φD	8	10	12.5	16
P	3.5	5.0	5.0	7.5
φd	0.6	0.6	0.6"	0.8
β	0.8	0.8	1.0	1.0

※ In case L > 25 for the φ12.5 dia. unit, lead dia. φ d = 0.8mm.

- Please refer to the Guidelines for Aluminum Electrolytic Capacitors for end seal configuration information.

Frequency coefficient of rated ripple current

V	CV	Frequency			
		120Hz	300Hz	1kHz	10kHz or more
10 to 100	1000 > CV	0.50	0.64	0.83	1.00
	1000 ≤ CV	0.67	0.79	0.91	1.00

Type numbering system (Example : 10V 220µF)

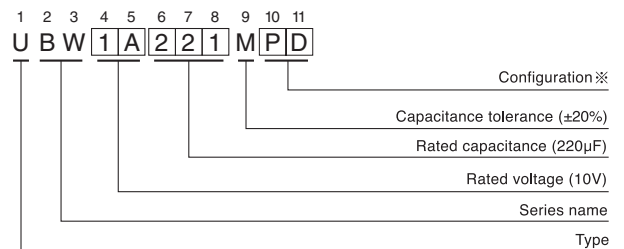

※ Configuration

φ D	Pb-free leadwire Pb-free Polyolefin sleeve
8, 10	PD
12.5 · 16	HD

● Dimension table in next page.

UBW

■ Dimensions

Rated Voltage (V) (code)	Rated Capacitance (μF)	Case Size φD×L (mm)	tan δ	Leakage Current (μA) (at 20°C after 1 minute)	Impedance (Ω) max. (20°C/100kHz)	Rated Ripple (mArms) (135°C/100kHz)	Part Number
10 (1A)	220	8×11.5	0.20	66	0.26	340	UBW1A221MPD
	330	10×12.5	0.20	99	0.15	620	UBW1A331MPD
	470	10×12.5	0.20	141	0.10	680	UBW1A471MPD
	1000	10×20	0.20	300	0.057	1100	UBW1A102MPD
	2200	12.5×25	0.22	660	0.033	1750	UBW1A222MHD
	3300	16×25	0.24	990	0.024	2300	UBW1A332MHD
	4700	16×30.5	0.26	1410	0.020	2710	UBW1A472MHD
16 (1C)	100	8×11.5	0.16	48	0.32	340	UBW1C101MPD
	220	10×12.5	0.16	105.6	0.15	620	UBW1C221MPD
	330	10×12.5	0.16	158.4	0.10	680	UBW1C331MPD
	470	10×16	0.16	225.6	0.075	945	UBW1C471MPD
	1000	12.5×20	0.16	480	0.042	1490	UBW1C102MHD
	2200	16×25	0.18	1056	0.024	2300	UBW1C222MHD
	3300	16×30.5	0.20	1584	0.020	2710	UBW1C332MHD
25 (1E)	100	8×11.5	0.14	75	0.13	500	UBW1E101MPD
	220	10×12.5	0.14	165	0.10	680	UBW1E221MPD
	330	10×16	0.14	247.5	0.075	945	UBW1E331MPD
	470	10×20	0.14	352.5	0.057	1100	UBW1E471MPD
	1000	12.5×25	0.14	750	0.033	1750	UBW1E102MHD
	2200	16×30.5	0.16	1650	0.020	2710	UBW1E222MHD
	3300	16×30.5	0.16	1650	0.020	2710	UBW1E222MHD
35 (1V)	100	10×12.5	0.12	105	0.15	620	UBW1V101MPD
	220	10×16	0.12	231	0.094	790	UBW1V221MPD
	330	10×20	0.12	346.5	0.075	950	UBW1V331MPD
	470	12.5×20	0.12	493.5	0.058	1330	UBW1V471MHD
	1000	16×25	0.12	1050	0.031	2010	UBW1V102MHD
50 (1H)	4.7	8×11.5	0.10	7.05	1.15	85	UBW1H4R7MPD
	10	8×11.5	0.10	15	0.75	180	UBW1H100MPD
	22	8×11.5	0.10	33	0.50	250	UBW1H220MPD
	33	8×11.5	0.10	49.5	0.45	300	UBW1H330MPD
	47	8×11.5	0.10	70.5	0.35	440	UBW1H470MPD
	100	10×12.5	0.10	150	0.18	555	UBW1H101MPD
	220	10×20	0.10	330	0.098	930	UBW1H221MPD
	330	12.5×20	0.10	495	0.070	1330	UBW1H331MHD
	470	12.5×25	0.10	705	0.055	1650	UBW1H471MHD
	1000	16×30.5	0.10	1500	0.031	2430	UBW1H102MHD
63 (1J)	22	8×11.5	0.10	41.58	2.00	130	UBW1J220MPD
	33	8×11.5	0.10	62.37	1.50	150	UBW1J330MPD
	47	10×12.5	0.10	88.83	0.59	530	UBW1J470MPD
	100	10×16	0.10	189	0.41	690	UBW1J101MPD
	220	12.5×20	0.10	415.8	0.16	1050	UBW1J221MHD
	330	12.5×25	0.10	623.7	0.12	1290	UBW1J331MHD
	470	12.5×30.5	0.10	888.3	0.097	1460	UBW1J471MHD
	1000	16×30.5	0.10	1890	0.055	1900	UBW1J102MHD

For cut leads, formed leads or taped parts, please add the appropriate code after the size code (12th digit).
If there is no size code in the part number, please add size code "1" and then add the appropriate code.

UBW

■ Dimensions

Rated Voltage (V) (code)	Rated Capacitance (μF)	Case Size φD×L (mm)	tan δ	Leakage Current (μA) (at 20°C after 1 minute)	Impedance (Ω) max. (20°C/100kHz)	Rated Ripple (mA rms) (135°C/100kHz)	Part Number
80 (1K)	22	8×11.5	0.08	52.8	1.50	150	UBW1K220MPD
	33	10×12.5	0.08	79.2	0.80	480	UBW1K330MPD
	47	10×12.5	0.08	112.8	0.80	480	UBW1K470MPD
	100	10×20	0.08	240	0.39	790	UBW1K101MPD
	220	12.5×25	0.08	528	0.18	1240	UBW1K221MHD
	330	12.5×30.5	0.08	792	0.16	1390	UBW1K331MHD
	470	16×25	0.08	1128	0.11	1500	UBW1K471MHD
100 (2A)	10	8×11.5	0.08	30	1.50	150	UBW2A100MPD
	22	10×12.5	0.08	66	0.80	480	UBW2A220MPD
	33	10×12.5	0.08	99	0.80	480	UBW2A330MPD
	47	10×16	0.08	141	0.55	630	UBW2A470MPD
	100	12.5×20	0.08	300	0.25	990	UBW2A101MHD
	220	16×25	0.08	660	0.11	1500	UBW2A221MHD
	330	16×30.5	0.08	990	0.079	1790	UBW2A331MHD

For cut leads, formed leads or taped parts, please add the appropriate code after the size code (12th digit).
 If there is no size code in the part number, please add size code "1" and then add the appropriate code.

- For formed lead or taped product specifications and minimum order quantity, please refer to the Guidelines for Aluminum Electrolytic Capacitors.

ALUMINUM ELECTROLYTIC CAPACITORS

UBY

High Temperature Range,
For +125°C or 135°C Use



- Higher capacitance and higher ripple current than UBT and UBW.
- Ideal for automobile control circuits such as electric power steering and direct injection engine drive.
- Compliant to the RoHS directive (2011/65/EU, (EU)2015/863).
- AEC-Q200 Qualified. Please contact us for details.



Specifications

Item	Performance Characteristics																							
Category Temperature Range	-40 to +135°C																							
Rated Voltage Range	25 to 100V																							
Rated Capacitance Range	160 to 12000μF																							
Capacitance Tolerance	±20% at 120Hz, 20°C																							
Leakage Current ※	After 1 minute's application of rated voltage at 20°C, leakage current is not more than 0.03CV (μA)																							
Tangent of loss angle (tan δ)	<table border="1"> <tr> <td>Rated voltage (V)</td> <td>25</td> <td>35</td> <td>50</td> <td>63</td> <td>80</td> <td>100</td> </tr> <tr> <td>tan δ (max.)</td> <td>0.14</td> <td>0.12</td> <td>0.10</td> <td>0.10</td> <td>0.08</td> <td>0.08</td> </tr> </table> <p>120Hz, 20°C For capacitance of more than 1000μF, add 0.02 for every increase of 1000μF.</p>	Rated voltage (V)	25	35	50	63	80	100	tan δ (max.)	0.14	0.12	0.10	0.10	0.08	0.08									
Rated voltage (V)	25	35	50	63	80	100																		
tan δ (max.)	0.14	0.12	0.10	0.10	0.08	0.08																		
Stability at Low Temperature	<table border="1"> <tr> <td colspan="2">Rated voltage (V)</td> <td>25</td> <td>35</td> <td>50</td> <td>63</td> <td>80</td> <td>100</td> </tr> <tr> <td rowspan="2">Impedance ratio (max.)</td> <td>Z(-25°C) / Z(+20°C)</td> <td>2</td> <td>2</td> <td>2</td> <td>2</td> <td>2</td> <td>2</td> </tr> <tr> <td>Z(-40°C) / Z(+20°C)</td> <td>4</td> <td>4</td> <td>4</td> <td>4</td> <td>4</td> <td>4</td> </tr> </table> <p>120Hz</p>	Rated voltage (V)		25	35	50	63	80	100	Impedance ratio (max.)	Z(-25°C) / Z(+20°C)	2	2	2	2	2	2	Z(-40°C) / Z(+20°C)	4	4	4	4	4	4
Rated voltage (V)		25	35	50	63	80	100																	
Impedance ratio (max.)	Z(-25°C) / Z(+20°C)	2	2	2	2	2	2																	
	Z(-40°C) / Z(+20°C)	4	4	4	4	4	4																	
Endurance	<p>The specifications listed at right shall be met when the capacitors are restored to 20°C after D.C. bias plus rated ripple current is applied for the time shown in right table at 125°C or 135°C, the peak voltage shall not exceed the rated voltage.</p> <table border="1"> <tr> <td>Rated voltage</td> <td>Temperature</td> <td>Time</td> </tr> <tr> <td rowspan="2">25 to 50V</td> <td>125°C</td> <td>3000hours</td> </tr> <tr> <td>135°C</td> <td>3000hours</td> </tr> <tr> <td rowspan="2">63 to 100V</td> <td>125°C</td> <td>3000hours</td> </tr> <tr> <td>135°C</td> <td>2000hours</td> </tr> </table> <table border="1"> <tr> <td>Capacitance change</td> <td>Within ±30% of the initial capacitance value</td> </tr> <tr> <td>tan δ</td> <td>300% or less than the initial specified value</td> </tr> <tr> <td>Leakage current</td> <td>Less than or equal to the initial specified value</td> </tr> </table>	Rated voltage	Temperature	Time	25 to 50V	125°C	3000hours	135°C	3000hours	63 to 100V	125°C	3000hours	135°C	2000hours	Capacitance change	Within ±30% of the initial capacitance value	tan δ	300% or less than the initial specified value	Leakage current	Less than or equal to the initial specified value				
Rated voltage	Temperature	Time																						
25 to 50V	125°C	3000hours																						
	135°C	3000hours																						
63 to 100V	125°C	3000hours																						
	135°C	2000hours																						
Capacitance change	Within ±30% of the initial capacitance value																							
tan δ	300% or less than the initial specified value																							
Leakage current	Less than or equal to the initial specified value																							
Shelf Life	After storing the capacitors under no load at 125°C for 1000 hours and then performing voltage treatment based on JIS C 5101-4 clause 4.1 at 20°C, they shall meet the specified values for the endurance characteristics listed above.																							
Marking	Black print on the case top.																							

The UBY series places emphasis on high ripple current, as a result the lifetime calculation is different than other series. Please contact Nichicon for details.

※ I : Leakage Current (μA), C : Rated Capacitance (μF), V : Rated Voltage (V)

Radial Lead Type

Type numbering system (Example : 25V 12000μF)

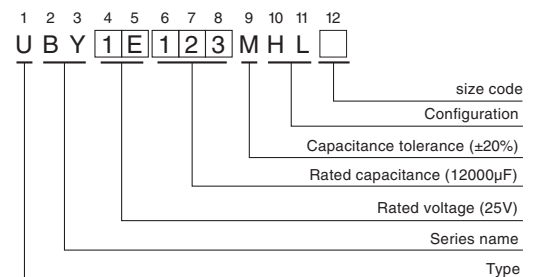
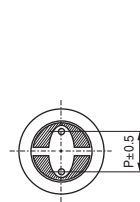
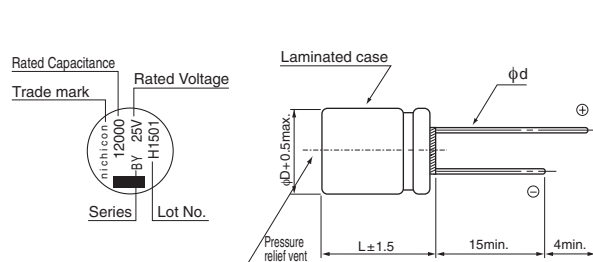

	(mm)		
φD	12.5	16	18
P	5.0	7.5	7.5
φd	0.6※	0.8	0.8

※ In case L > 25 for the φ12.5 dia. unit, lead dia. φd = 0.8mm.

Frequency coefficient of rated ripple current

Cap. (μF)	Frequency			
	120Hz	1kHz	10kHz	100kHz or more
160	0.40	0.75	0.90	1.00
220 to 620	0.50	0.85	0.94	1.00
680 to 2000	0.60	0.87	0.95	1.00
2200 to 4300	0.75	0.90	0.95	1.00
4700 to 12000	0.85	0.95	0.98	1.00

• Dimension table in next page.



■ Dimensions

Rated Voltage (V) (code)	Rated Capacitance (μF)	Case Size φD×L (mm)	tan δ	Leakage Current (μA) (at 20°C after 1 minute)	ESR (Ω) max.		Rated Ripple (mA _{rms})		Part Number
					20°C/100kHz	-40°C/100kHz	125°C/100kHz	135°C/100kHz	
25 (1E)	2000	12.5×20	0.16	1500	0.042	0.48	2760	1690	UBY1E202MHL
	3000	12.5×25	0.18	2250	0.033	0.30	3480	2010	UBY1E302MHL
	3300	16×20	0.18	2475	0.031	0.27	3040	1860	UBY1E332MHL
	3600	12.5×30.5	0.18	2700	0.028	0.24	4490	2900	UBY1E362MHL
	4300	18×20	0.20	3225	0.030	0.22	3250	1870	UBY1E432MHL
	4700	16×25	0.20	3525	0.026	0.22	4260	2870	UBY1E472MHL
	5100	12.5×40	0.22	3825	0.024	0.19	5810	3470	UBY1E512MHL
	6200	16×30.5	0.24	4650	0.023	0.18	5480	3400	UBY1E622MHL
	6200	18×25	0.24	4650	0.025	0.19	4500	2900	UBY1E622MHL6
	7500	16×35.5	0.26	5625	0.020	0.14	6070	3630	UBY1E752MHL
	8200	18×30.5	0.28	6150	0.022	0.16	5600	3470	UBY1E822MHL
	9100	16×40	0.30	6825	0.019	0.12	6810	3930	UBY1E912MHL
	10000	18×35.5	0.32	7500	0.019	0.12	6280	3750	UBY1E103MHL
12000	18×40	0.36	9000	0.018	0.10	7070	4080	UBY1E123MHL	
35 (1V)	1300	12.5×20	0.12	1365	0.042	0.48	2760	1690	UBY1V132MHL
	1800	12.5×25	0.12	1890	0.033	0.30	3480	2010	UBY1V182MHL
	2200	12.5×30.5	0.14	2310	0.028	0.24	4490	2900	UBY1V222MHL
	2200	16×20	0.14	2310	0.031	0.27	3040	1860	UBY1V222MHL6
	2700	12.5×35.5	0.14	2835	0.025	0.21	5140	3190	UBY1V272MHL
	2700	18×20	0.14	2835	0.030	0.22	3250	1870	UBY1V272MHL6
	3000	16×25	0.16	3150	0.026	0.22	4260	2870	UBY1V302MHL
	3300	12.5×40	0.16	3465	0.024	0.19	5810	3470	UBY1V332MHL
	3900	16×30.5	0.16	4095	0.023	0.18	5480	3400	UBY1V392MHL
	3900	18×25	0.16	4095	0.025	0.19	4500	2900	UBY1V392MHL6
	4700	16×35.5	0.18	4935	0.020	0.14	6070	3630	UBY1V472MHL
	5100	18×30.5	0.20	5355	0.022	0.16	5600	3470	UBY1V512MHL
	5600	16×40	0.20	5880	0.019	0.12	6810	3930	UBY1V562MHL
	6200	18×35.5	0.22	6510	0.019	0.12	6280	3750	UBY1V622MHL
	7500	18×40	0.24	7875	0.018	0.10	7070	4080	UBY1V752MHL
50 (1H)	620	12.5×20	0.10	930	0.056	0.52	2400	1470	UBY1H621MHL
	820	12.5×25	0.10	1230	0.044	0.35	3350	2260	UBY1H821MHL
	1000	16×20	0.10	1500	0.039	0.30	2960	1870	UBY1H102MHL
	1100	12.5×30.5	0.10	1650	0.037	0.26	4220	2520	UBY1H112MHL
	1300	12.5×35.5	0.10	1950	0.033	0.23	4810	2780	UBY1H132MHL
	1300	16×25	0.10	1950	0.033	0.22	4040	2500	UBY1H132MHL6
	1300	18×20	0.10	1950	0.038	0.20	3130	2110	UBY1H132MHL3
	1600	12.5×40	0.10	2400	0.032	0.20	5240	3020	UBY1H162MHL
	1800	16×30.5	0.10	2700	0.029	0.19	5130	2960	UBY1H182MHL
	1800	18×25	0.10	2700	0.032	0.19	4230	2530	UBY1H182MHL6
	2200	16×35.5	0.12	3300	0.025	0.14	5480	3160	UBY1H222MHL
	2400	18×30.5	0.12	3600	0.025	0.16	5240	3020	UBY1H242MHL
	2700	16×40	0.12	4050	0.022	0.13	5930	3420	UBY1H272MHL
	3000	18×35.5	0.14	4500	0.022	0.12	5870	3390	UBY1H302MHL
	3600	18×40	0.14	5400	0.020	0.10	6420	3700	UBY1H362MHL

For cut leads, formed leads or taped parts, please add the appropriate code after the size code (12th digit).
 If there is no size code in the part number, please add size code "1" and then add the appropriate code.

UBY

■ Dimensions

Rated Voltage (V) (code)	Rated Capacitance (μF)	Case Size φD×L (mm)	tan δ	Leakage Current (μA) (at 20°C after 1 minute)	ESR (Ω) max.		Rated Ripple (mArms)		Part Number
					20°C/ 100kHz	-40°C/ 100kHz	125°C/ 100kHz	135°C/ 100kHz	
63 (1J)	390	12.5×20	0.10	737.1	0.074	0.56	1640	1420	UBY1J391MHL
	560	12.5×25	0.10	1058.4	0.054	0.39	2520	2050	UBY1J561MHL
	750	12.5×30.5	0.10	1417.5	0.042	0.30	3110	2630	UBY1J751MHL
	750	16×20	0.10	1417.5	0.053	0.34	2140	1910	UBY1J751MHL6
	950	12.5×35.5	0.10	1795.5	0.038	0.25	3760	2970	UBY1J951MHL
	950	18×20	0.10	1795.5	0.048	0.26	2350	2100	UBY1J951MHL6
	1000	16×25	0.10	1890	0.038	0.23	2940	2680	UBY1J102MHL
	1100	12.5×40	0.10	2079	0.031	0.22	4610	3260	UBY1J112MHL
	1300	16×30.5	0.10	2457	0.034	0.20	3860	3050	UBY1J132MHL
	1300	18×25	0.10	2457	0.035	0.19	3080	2810	UBY1J132MHL6
	1700	16×35.5	0.10	3213	0.027	0.15	4590	3420	UBY1J172MHL
	1800	18×30.5	0.10	3402	0.028	0.15	4080	3220	UBY1J182MHL
	2000	16×40	0.12	3780	0.025	0.14	5190	3670	UBY1J202MHL
	2200	18×35.5	0.12	4158	0.023	0.12	5220	3690	UBY1J222MHL
2500	18×40	0.12	4725	0.021	0.11	5660	3820	UBY1J252MHL	
80 (1K)	270	12.5×20	0.08	648	0.074	0.56	1640	1420	UBY1K271MHL
	390	12.5×25	0.08	936	0.054	0.39	2520	2050	UBY1K391MHL
	470	16×20	0.08	1128	0.053	0.34	2140	1910	UBY1K471MHL
	510	12.5×30.5	0.08	1224	0.042	0.30	3110	2630	UBY1K511MHL
	620	12.5×35.5	0.08	1488	0.038	0.25	3760	2970	UBY1K621MHL
	620	18×20	0.08	1488	0.048	0.26	2350	2100	UBY1K621MHL6
	680	16×25	0.08	1632	0.038	0.23	2940	2680	UBY1K681MHL
	750	12.5×40	0.08	1800	0.031	0.22	4610	3260	UBY1K751MHL
	820	16×30.5	0.08	1968	0.034	0.20	3860	3050	UBY1K821MHL
	820	18×25	0.08	1968	0.035	0.19	3080	2810	UBY1K821MHL6
	1000	16×35.5	0.08	2400	0.027	0.15	4590	3420	UBY1K102MHL
	1100	18×30.5	0.08	2640	0.028	0.15	4080	3220	UBY1K112MHL
	1300	16×40	0.08	3120	0.025	0.14	5190	3670	UBY1K132MHL
	1300	18×35.5	0.08	3120	0.023	0.12	5220	3690	UBY1K132MHL6
1600	18×40	0.08	3840	0.021	0.11	5660	3820	UBY1K162MHL	
100 (2A)	160	12.5×20	0.08	480	0.074	0.56	1640	1420	UBY2A161MHL
	220	12.5×25	0.08	660	0.054	0.39	2520	2050	UBY2A221MHL
	270	16×20	0.08	810	0.053	0.34	2140	1910	UBY2A271MHL
	300	12.5×30.5	0.08	900	0.042	0.30	3110	2630	UBY2A301MHL
	360	12.5×35.5	0.08	1080	0.038	0.25	3760	2970	UBY2A361MHL
	360	18×20	0.08	1080	0.048	0.26	2350	2100	UBY2A361MHL6
	390	16×25	0.08	1170	0.038	0.23	2940	2680	UBY2A391MHL
	430	12.5×40	0.08	1290	0.031	0.22	4610	3260	UBY2A431MHL
	470	16×30.5	0.08	1410	0.034	0.20	3860	3050	UBY2A471MHL
	510	18×25	0.08	1530	0.035	0.19	3080	2810	UBY2A511MHL
	560	16×35.5	0.08	1680	0.027	0.15	4590	3420	UBY2A561MHL
	680	18×30.5	0.08	2040	0.028	0.15	4080	3220	UBY2A681MHL
	750	16×40	0.08	2250	0.025	0.14	5190	3670	UBY2A751MHL
	820	18×35.5	0.08	2460	0.023	0.12	5220	3690	UBY2A821MHL
	950	18×40	0.08	2850	0.021	0.11	5660	3820	UBY2A951MHL

For cut leads, formed leads or taped parts, please add the appropriate code after the size code (12th digit).
If there is no size code in the part number, please add size code "1" and then add the appropriate code.

• For formed lead or taped product specifications and minimum order quantity, please refer to the Guidelines for Aluminum Electrolytic Capacitors.

UXY

Miniature Sized, Vibration Resistance
For +125°C or 135°C Use
(125°C / 135°C 3000hour)

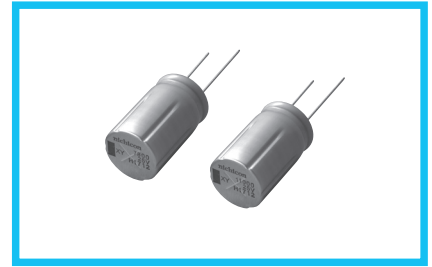

- Anti-vibration structuring than UBY.
- Suited for automobile electronics where heavy duty services are indispensable.
- Compliant to the RoHS directive (2011/65/EU, (EU)2015/863).
- AEC-Q200 Qualified. Please contact us for details.



Specifications

Item	Performance Characteristics																
Category Temperature Range	-40 to +135°C																
Rated Voltage Range	25 to 35V																
Rated Capacitance Range	5000 to 11000μF																
Capacitance Tolerance	±20% at 120Hz, 20°C																
Leakage Current ※	After 1 minute's application of rated voltage at 20°C, leakage current is not more than 0.03CV (μA)																
Tangent of loss angle (tan δ)	<table border="1"> <tr> <td>Rated voltage (V)</td> <td>25</td> <td>35</td> <td rowspan="2">120Hz, 20°C</td> </tr> <tr> <td>tan δ (max.)</td> <td>0.14</td> <td>0.12</td> </tr> </table> <p>For capacitance of more than 1000μF, add 0.02 for every increase of 1000μF.</p>	Rated voltage (V)	25	35	120Hz, 20°C	tan δ (max.)	0.14	0.12									
Rated voltage (V)	25	35	120Hz, 20°C														
tan δ (max.)	0.14	0.12															
Stability at Low Temperature	<table border="1"> <tr> <td rowspan="2">Impedance ratio (max.)</td> <td>Rated voltage (V)</td> <td>25</td> <td>35</td> <td rowspan="2">120Hz</td> </tr> <tr> <td>Z(-25°C) / Z(+20°C)</td> <td>2</td> <td>2</td> </tr> <tr> <td></td> <td>Z(-40°C) / Z(+20°C)</td> <td>4</td> <td>4</td> <td></td> </tr> </table>	Impedance ratio (max.)	Rated voltage (V)	25	35	120Hz	Z(-25°C) / Z(+20°C)	2	2		Z(-40°C) / Z(+20°C)	4	4				
Impedance ratio (max.)	Rated voltage (V)		25	35	120Hz												
	Z(-25°C) / Z(+20°C)	2	2														
	Z(-40°C) / Z(+20°C)	4	4														
Endurance	<p>The specifications listed below shall be met when the capacitors are restored to 20°C after D.C. bias plus rated ripple current is applied for 3000 hours at 125°C or 135°C, the peak voltage shall not exceed the rated voltage.</p> <table border="1"> <tr> <td>Capacitance change</td> <td>Within ±30% of the initial capacitance value</td> </tr> <tr> <td>tan δ</td> <td>300% or less than the initial specified value</td> </tr> <tr> <td>Leakage current</td> <td>Less than or equal to the initial specified value</td> </tr> </table>	Capacitance change	Within ±30% of the initial capacitance value	tan δ	300% or less than the initial specified value	Leakage current	Less than or equal to the initial specified value										
Capacitance change	Within ±30% of the initial capacitance value																
tan δ	300% or less than the initial specified value																
Leakage current	Less than or equal to the initial specified value																
Shelf Life	After storing the capacitors under no load at 125°C for 1000 hours and then performing voltage treatment based on JIS C 5101-4 clause 4.1 at 20°C, they shall meet the specified values for the endurance characteristics listed above.																
Vibration	<p>The specifications listed below shall be met when the capacitors are restored to 20°C after subjected to vibration conditions at room temperature(15 to 35°C).</p> <table border="1"> <tr> <td>Capacitance change</td> <td>Within ±5% of the initial capacitance value</td> </tr> <tr> <td>tan δ</td> <td>Less than or equal to the initial specified value</td> </tr> <tr> <td>Leakage current</td> <td>Less than or equal to the initial specified value</td> </tr> </table> <p>Vibration conditions</p> <table border="1"> <tr> <td>Vibration frequency range</td> <td>10 to 2000Hz</td> </tr> <tr> <td>Amplitude or acceleration</td> <td>Total amplitude either 1.5mm or 392m/s²(40G) whichever is looser</td> </tr> <tr> <td>Sweep rate</td> <td>0.5 octaves/minute</td> </tr> <tr> <td>Vibration direction and time</td> <td>X, Y, Z in each direction for two hours, totalling six hours</td> </tr> <tr> <td>Fixed</td> <td>Fixed product and lead lines on stationary object (please inquire for more details)</td> </tr> </table>	Capacitance change	Within ±5% of the initial capacitance value	tan δ	Less than or equal to the initial specified value	Leakage current	Less than or equal to the initial specified value	Vibration frequency range	10 to 2000Hz	Amplitude or acceleration	Total amplitude either 1.5mm or 392m/s ² (40G) whichever is looser	Sweep rate	0.5 octaves/minute	Vibration direction and time	X, Y, Z in each direction for two hours, totalling six hours	Fixed	Fixed product and lead lines on stationary object (please inquire for more details)
Capacitance change	Within ±5% of the initial capacitance value																
tan δ	Less than or equal to the initial specified value																
Leakage current	Less than or equal to the initial specified value																
Vibration frequency range	10 to 2000Hz																
Amplitude or acceleration	Total amplitude either 1.5mm or 392m/s ² (40G) whichever is looser																
Sweep rate	0.5 octaves/minute																
Vibration direction and time	X, Y, Z in each direction for two hours, totalling six hours																
Fixed	Fixed product and lead lines on stationary object (please inquire for more details)																
Marking	Black print on the case top.																

The UXY series places emphasis on high ripple current, as a result the lifetime calculation is different than other series. Please contact Nichicon for details.

※ I : Leakage Current (μA), C : Rated Capacitance (μF), V : Rated Voltage (V)

Radial Lead Type

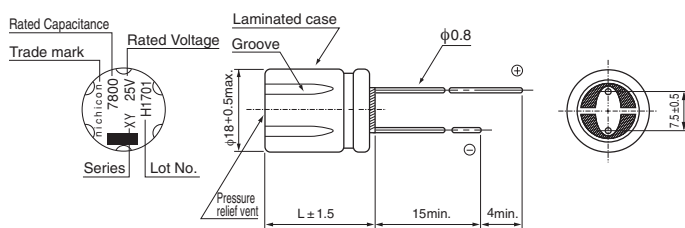

Type numbering system (Example : 25V 7800μF)

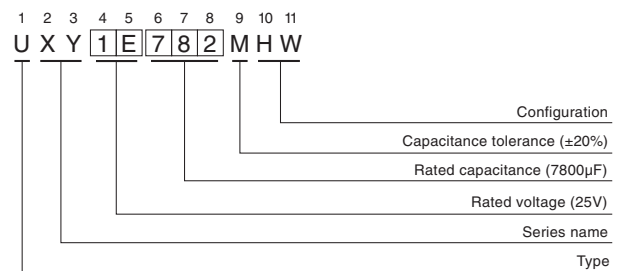

Frequency coefficient of rated ripple current

Frequency	120Hz	1kHz	10kHz	100kHz or more
Coefficient	0.85	0.95	0.98	1.00

● Dimension table in next page.

UXY

■ Dimensions

Rated Voltage (V) (code)	Rated Capacitance (μ F)	Case Size ϕ D \times L (mm)	tan δ	Leakage Current (μ A) (at 20°C after 1 minute)	ESR (Ω) max.		Rated Ripple (mArms)		Part Number
					20°C/ 100kHz	-40°C/ 100kHz	125°C/ 100kHz	135°C/ 100kHz	
25 (1E)	7800	18 \times 30.5	0.26	5850	0.023	0.19	5380	3330	UXY1E782MHW
	11000	18 \times 40	0.34	8250	0.019	0.13	6800	3900	UXY1E113MHW
35 (1V)	5000	18 \times 30.5	0.20	5250	0.023	0.19	5380	3330	UXY1V502MHW
	7300	18 \times 40	0.24	7665	0.019	0.13	6800	3900	UXY1V732MHW

For cut leads, formed leads or taped parts, please add the appropriate code after the size code (12th digit).

If there is no size code in the part number, please add size code "1" and then add the appropriate code.

- For formed lead or taped product specifications and minimum order quantity, please refer to the Guidelines for Aluminum Electrolytic Capacitors.

ALUMINUM ELECTROLYTIC CAPACITORS

UBX High Temperature Range, For +150°C Use



Long Life

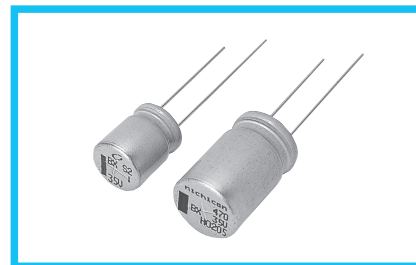

- Laminated case series.
- Suited for automobile electronics where heavy duty services are indispensable.
- Compliant to the RoHS directive (2011/65/EU,(EU)2015/863).
- AEC-Q200 compliant. Please contact us for details.

Valued marked with an ※ in the dimension table are scheduled to be discontinued and are not recommended for new designs.



Specifications

Item	Performance Characteristics	
Category Temperature Range	-55 to +150°C (10 to 100V), -40 to +150°C (160 · 200V), -25 to +150°C (350 · 400V)	
Rated Voltage Range	10 to 400V	
Rated Capacitance Range	6.8 to 4700µF	
Capacitance Tolerance	±20% at 120Hz, 20°C	
Leakage Current ※	Rated Voltage (V)	10 to 100
	Leakage current	After 1 minute's application of rated voltage at 20°C, leakage current is not more than 0.03CV (µA).
Tangent of loss angle (tan δ)	Rated voltage (V)	10 16 25 35 50 63 80 100 160·200 350·400
	tan δ (max.)	0.20 0.16 0.14 0.12 0.10 0.10 0.08 0.08 0.20 0.24
Stability at Low Temperature	Rated voltage (V)	10 16 25 35 50 63 80 100 160·200 350·400
	Impedance ratio (max.)	Z(-25°C) / Z(+20°C): 3 2 2 2 2 2 2 2 3 6 Z(-40°C) / Z(+20°C): 4 4 4 4 4 4 4 4 6 -
Endurance	Capacitance change	Within ±30% of the initial capacitance value (10 to 100V) Within ±20% of the initial capacitance value (160 to 400V)
	tan δ	300% or less than the initial specified value (10 to 100V) 200% or less than the initial specified value(160 to 400V)
Marking	Leakage current	Less than or equal to the initial specified value
	Marking	Black print on the case top.

※ I : Leakage Current (µA), C : Rated Capacitance (µF), V : Rated Voltage (V)

Radial Lead Type

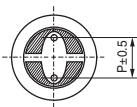
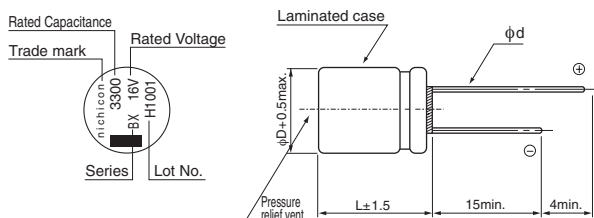

	(mm)		
φD	12.5	16	18
P	5.0	7.5	7.5
φd	0.6	0.8	0.8

Type numbering system (Example : 16V 3300µF)

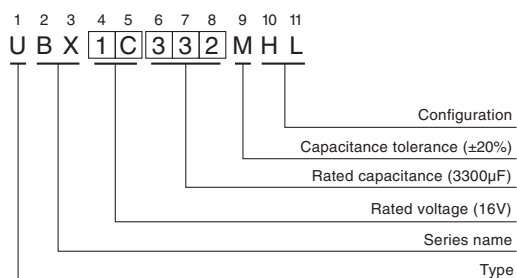

Frequency coefficient of rated ripple current

V	CV	Frequency			
		120Hz	300Hz	1kHz	10kHz or more
10 to 100	1000 > CV	0.50	0.64	0.83	1.00
	1000 ≤ CV	0.67	0.79	0.91	1.00

V	Cap. (µF)	Frequency					
		50Hz	120Hz	300Hz	1kHz	10kHz	100kHz or more
160 to 400	6.8 to 33	0.75	1.00	1.25	1.50	1.75	1.80
	47 to 100	0.80	1.00	1.15	1.30	1.40	1.50

- Please refer to the Guidelines for Aluminum Electrolytic Capacitors for end seal configuration information.

• Dimension table in next page.

UBX

■ Dimensions

Rated Voltage (V) (code)	Rated Capacitance (μ F)	Case Size ϕ D \times L (mm)	tan δ	Leakage Current (μ A) (at 20°C after 1 minute)	Rated Ripple (mArms)		Part Number
					150°C/ 100kHz	150°C/ 120Hz	
10 (1A)	1000	12.5 \times 25	0.20	300	600	—	※UBX1A102MHL
	2200	16 \times 30.5	0.22	660	1000	—	※UBX1A222MHL
	3300	18 \times 35.5	0.24	990	1200	—	※UBX1A332MHL
	4700	18 \times 40	0.26	1410	1300	—	※UBX1A472MHL
16 (1C)	470	12.5 \times 20	0.16	225.6	600	—	UBX1C471MHL
	1000	16 \times 25	0.16	480	800	—	UBX1C102MHL
	2200	18 \times 35.5	0.18	1056	1200	—	UBX1C222MHL
	3300	18 \times 40	0.20	1584	1300	—	UBX1C332MHL
25 (1E)	220	12.5 \times 20	0.14	165	500	—	UBX1E221MHL
	330	12.5 \times 25	0.14	247.5	600	—	UBX1E331MHL
	470	16 \times 25	0.14	352.5	800	—	UBX1E471MHL
	1000	16 \times 30.5	0.14	750	1000	—	UBX1E102MHL
35 (1V)	220	12.5 \times 25	0.12	231	600	—	UBX1V221MHL
	330	16 \times 25	0.12	346.5	800	—	UBX1V331MHL
	470	16 \times 30.5	0.12	493.5	1000	—	UBX1V471MHL
	1000	18 \times 40	0.12	1050	1300	—	UBX1V102MHL
50 (1H)	330	12.5 \times 20	0.10	495	770	—	UBX1H331MHL
	470	12.5 \times 25	0.10	705	960	—	UBX1H471MHL
	560	12.5 \times 30.5	0.10	840	1080	—	UBX1H561MHL
	680	16 \times 25	0.10	1020	1190	—	UBX1H681MHL
	1000	16 \times 30.5	0.10	1500	1420	—	UBX1H102MHL
63 (1J)	220	12.5 \times 25	0.10	415.8	1040	—	UBX1J221MHL
	330	12.5 \times 30.5	0.10	623.7	1170	—	UBX1J331MHL
	470	16 \times 25	0.10	888.3	1280	—	UBX1J471MHL
	560	16 \times 30.5	0.10	1058.4	1520	—	UBX1J561MHL
	680	16 \times 35.5	0.10	1285.2	1520	—	UBX1J681MHL
80 (1K)	100	12.5 \times 20	0.08	240	820	—	UBX1K101MHL
	220	16 \times 25	0.08	528	1250	—	UBX1K221MHL
	330	16 \times 30.5	0.08	792	1480	—	UBX1K331MHL
	470	18 \times 30.5	0.08	1128	1530	—	UBX1K471MHL
100 (2A)	68	12.5 \times 20	0.08	204	760	—	UBX2A680MHL
	100	12.5 \times 25	0.08	300	950	—	UBX2A101MHL
	220	16 \times 30.5	0.08	660	1380	—	UBX2A221MHL
	330	18 \times 30.5	0.08	990	1430	—	UBX2A331MHL
160 (2C)	33	12.5 \times 20	0.20	311.2	—	230	UBX2C330MHL
	47	12.5 \times 20	0.20	400.8	—	250	UBX2C470MHL
	56	12.5 \times 25	0.20	458.4	—	270	UBX2C560MHL
	68	16 \times 20	0.20	535.2	—	290	UBX2C680MHL
	100	16 \times 25	0.20	740	—	300	UBX2C101MHL
200 (2D)	33	12.5 \times 20	0.20	364	—	210	UBX2D330MHL
	47	12.5 \times 25	0.20	476	—	250	UBX2D470MHL
	56	16 \times 20	0.20	548	—	270	UBX2D560MHL
	68	16 \times 25	0.20	644	—	290	UBX2D680MHL
350 (2V)	10	12.5 \times 20	0.24	240	—	120	UBX2V100MHL
	15	12.5 \times 25	0.24	310	—	130	UBX2V150MHL
400 (2G)	6.8	12.5 \times 20	0.24	208.8	—	88	UBX2G6R8MHL
	10	12.5 \times 25	0.24	260	—	105	UBX2G100MHL
	15	12.5 \times 25	0.24	340	—	105	UBX2G150MHL

For cut leads, formed leads or taped parts, please add the appropriate code after the size code (12th digit).
If there is no size code in the part number, please add size code "1" and then add the appropriate code.

• For formed lead or taped product specifications and minimum order quantity, please refer to the Guidelines for Aluminum Electrolytic Capacitors.

UKL

Low Leakage Current



- Standard low leakage current series.
- Compliant to the RoHS directive (2011/65/EU,(EU)2015/863).

Products which are scheduled to be discontinued.
Not recommended for new designs.

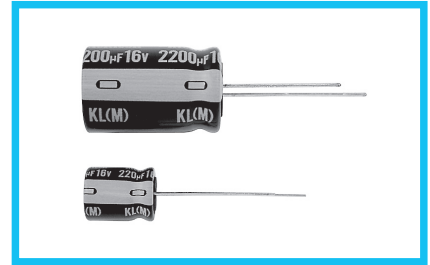

Specifications

Item	Performance Characteristics																															
Category Temperature Range	-40 to +85°C (-40 to +105°C product is also available upon request, but product rated at up to 50V less than or equal to φ10 × 12.5 Lmm)																															
Rated Voltage Range	6.3 to 100V																															
Rated Capacitance Range	10 to 10000µF																															
Capacitance Tolerance	±20% (M), ±10% (K) at 120Hz 20°C																															
Leakage Current ※	After 1 minute's (for case size 10 × 12.5 or smaller) or 2 minutes' (for case size 10 × 16 or larger) application of rated voltage at 20°C, leakage current is not more than 0.002CV (µA).																															
Tangent of loss angle (tan δ)	<table border="1"> <thead> <tr> <th colspan="2">Rated voltage (V)</th> <th>6.3</th> <th>10</th> <th>16</th> <th>25</th> <th>35</th> <th>50</th> <th>63</th> <th>100</th> <th>120Hz, 20°C</th> </tr> </thead> <tbody> <tr> <td rowspan="2">tan δ (max.)</td> <td>Less than φ10 × 12.5</td> <td>0.18</td> <td>0.15</td> <td>0.12</td> <td>0.08</td> <td>0.08</td> <td>0.08</td> <td>0.07</td> <td>0.07</td> <td rowspan="2"></td> </tr> <tr> <td>φ10 × 16 or more</td> <td>0.21</td> <td>0.17</td> <td>0.14</td> <td>0.12</td> <td>0.12</td> <td>0.10</td> <td>0.08</td> <td>0.08</td> </tr> </tbody> </table> <p>For capacitance of more than 1000µF, add 0.02 for every increase of 1000µF.</p>	Rated voltage (V)		6.3	10	16	25	35	50	63	100	120Hz, 20°C	tan δ (max.)	Less than φ10 × 12.5	0.18	0.15	0.12	0.08	0.08	0.08	0.07	0.07		φ10 × 16 or more	0.21	0.17	0.14	0.12	0.12	0.10	0.08	0.08
Rated voltage (V)		6.3	10	16	25	35	50	63	100	120Hz, 20°C																						
tan δ (max.)	Less than φ10 × 12.5	0.18	0.15	0.12	0.08	0.08	0.08	0.07	0.07																							
	φ10 × 16 or more	0.21	0.17	0.14	0.12	0.12	0.10	0.08	0.08																							
stability at Low Temperature	<table border="1"> <thead> <tr> <th colspan="2">Rated voltage (V)</th> <th>6.3</th> <th>10</th> <th>16</th> <th>25</th> <th>35</th> <th>50</th> <th>63</th> <th>100</th> <th>120Hz</th> </tr> </thead> <tbody> <tr> <td rowspan="2">Impedance ratio (max.)</td> <td>Z(-25°C) / Z(+20°C)</td> <td>3 (4)</td> <td>2 (3)</td> <td>2</td> <td>1.5</td> <td>1.5</td> <td>1.5</td> <td>1.5</td> <td>1.5</td> <td rowspan="2">Values in () applicable to φ10 × 16 or larger case size.</td> </tr> <tr> <td>Z(-40°C) / Z(+20°C)</td> <td>5 (8)</td> <td>4 (6)</td> <td>3 (4)</td> <td>2 (4)</td> <td>2 (3)</td> <td>2 (3)</td> <td>2 (3)</td> <td>2 (3)</td> </tr> </tbody> </table>	Rated voltage (V)		6.3	10	16	25	35	50	63	100	120Hz	Impedance ratio (max.)	Z(-25°C) / Z(+20°C)	3 (4)	2 (3)	2	1.5	1.5	1.5	1.5	1.5	Values in () applicable to φ10 × 16 or larger case size.	Z(-40°C) / Z(+20°C)	5 (8)	4 (6)	3 (4)	2 (4)	2 (3)	2 (3)	2 (3)	2 (3)
Rated voltage (V)		6.3	10	16	25	35	50	63	100	120Hz																						
Impedance ratio (max.)	Z(-25°C) / Z(+20°C)	3 (4)	2 (3)	2	1.5	1.5	1.5	1.5	1.5	Values in () applicable to φ10 × 16 or larger case size.																						
	Z(-40°C) / Z(+20°C)	5 (8)	4 (6)	3 (4)	2 (4)	2 (3)	2 (3)	2 (3)	2 (3)																							
Endurance	<p>The specifications listed at right shall be met when the capacitors are restored to 20°C after the rated voltage is applied for 2000 hours at 85°C, or 1000 hours at 105°C.</p> <table border="1"> <tr> <td>Capacitance change</td> <td>Within ±15% of the initial capacitance value (6.3V : Within ±20%)</td> </tr> <tr> <td>tan δ</td> <td>150% or less than the initial specified value</td> </tr> <tr> <td>Leakage current</td> <td>Less than or equal to the initial specified value</td> </tr> </table>	Capacitance change	Within ±15% of the initial capacitance value (6.3V : Within ±20%)	tan δ	150% or less than the initial specified value	Leakage current	Less than or equal to the initial specified value																									
Capacitance change	Within ±15% of the initial capacitance value (6.3V : Within ±20%)																															
tan δ	150% or less than the initial specified value																															
Leakage current	Less than or equal to the initial specified value																															
Shelf Life	After storing the capacitors under no load at 85°C for 1000 hours and then performing voltage treatment based on JIS C 5101-4 clause 4.1 at 20°C, they shall meet the specified values for the endurance characteristics listed above.																															
Marking	Printed with white color letter on black sleeve.																															

※ I : Leakage Current (µA), C : Rated Capacitance (µF), V : Rated Voltage (V)

Radial Lead Type

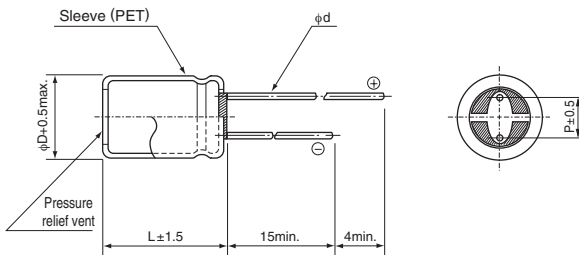

	(mm)				
φD	8	10	12.5	16	18
P	3.5	5.0	5.0	7.5	7.5
φd	0.6	0.6	0.6	0.8	0.8

- Please refer to the Guidelines for Aluminum Electrolytic Capacitors for end seal configuration information.

Frequency coefficient of rated ripple current

Cap. (µF)	Frequency				
10 to 68	50Hz	120Hz	300Hz	1kHz	10kHz or more
	0.75	1.00	1.35	1.57	2.00
100 to 680	0.80	1.00	1.23	1.34	1.50
1000 to 10000	0.85	1.00	1.10	1.13	1.15

Type numbering system (Example : 10V 150µF)

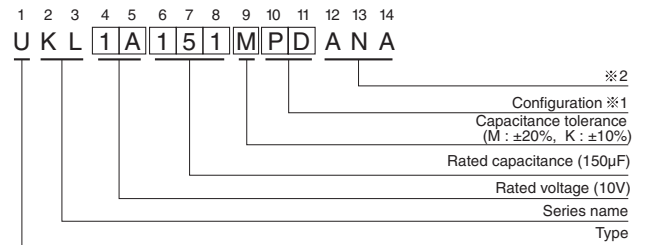

※1 Configuration

φ D	Pb-free leadwire Pb-free PET sleeve
8 · 10	PD
12.5 to 18	HD

※2 In case 105°C unit is required

● Dimension table in next page.

UKL

■ Dimensions

Rated Voltage (V) (code)	Rated Capacitance (μ F)	Case Size ϕ D×L (mm)	tan δ	Leakage Current (μ A)		Rated Ripple (mArms) (85°C/120Hz)	Part Number
				at 20°C after 1 minute	at 20°C after 2 minutes		
6.3 (0J)	470	10×12.5	0.18	5.922	—	390	UKL0J471MPD
	680	10×16	0.21	—	8.568	480	UKL0J681MPD
	1000	10×20	0.21	—	12.6	650	UKL0J102MPD
	1500	12.5×25	0.21	—	18.9	910	UKL0J152MHD
	2200	12.5×25	0.23	—	27.72	1060	UKL0J222MHD
	3300	16×25	0.25	—	41.58	1270	UKL0J332MHD
	4700	16×30.5	0.27	—	59.22	1500	UKL0J472MHD
	6800	18×35.5	0.31	—	85.68	1760	UKL0J682MHD
10000	18×40	0.39	—	126	1900	UKL0J103MHD	
10 (1A)	150	8×11.5	0.15	3	—	250	UKL1A151MPD
	220	8×11.5	0.15	4.4	—	310	UKL1A221MPD
	330	10×12.5	0.15	6.6	—	400	UKL1A331MPD
	470	10×16	0.17	—	9.4	530	UKL1A471MPD
	680	10×20	0.17	—	13.6	600	UKL1A681MPD
	1000	12.5×20	0.17	—	20	810	UKL1A102MHD
	1500	12.5×25	0.17	—	30	1020	UKL1A152MHD
	2200	16×25	0.19	—	44	1200	UKL1A222MHD
	3300	16×30.5	0.21	—	66	1420	UKL1A332MHD
	4700	16×35.5	0.23	—	94	1650	UKL1A472MHD
6800	18×35.5	0.27	—	136	1890	UKL1A682MHD	
16 (1C)	100	8×11.5	0.12	3.2	—	230	UKL1C101MPD
	150	8×11.5	0.12	4.8	—	280	UKL1C151MPD
	220	10×12.5	0.12	7.04	—	370	UKL1C221MPD
	330	10×16	0.14	—	10.56	420	UKL1C331MPD
	470	10×20	0.14	—	15.04	550	UKL1C471MPD
	680	12.5×20	0.14	—	21.76	730	UKL1C681MHD
	1000	12.5×25	0.14	—	32	910	UKL1C102MHD
	1500	16×25	0.14	—	48	1150	UKL1C152MHD
	2200	16×25	0.16	—	70.4	1300	UKL1C222MHD
	3300	16×35.5	0.18	—	105.6	1550	UKL1C332MHD
4700	18×35.5	0.20	—	150.4	1820	UKL1C472MHD	
25 (1E)	68	8×11.5	0.08	3.4	—	230	UKL1E680MPD
	100	8×11.5	0.08	5	—	280	UKL1E101MPD
	150	10×12.5	0.08	7.5	—	370	UKL1E151MPD
	220	10×16	0.12	—	11	400	UKL1E221MPD
	330	10×20	0.12	—	16.5	490	UKL1E331MPD
	470	12.5×20	0.12	—	23.5	660	UKL1E471MHD
	680	12.5×25	0.12	—	34	810	UKL1E681MHD
	1000	16×25	0.12	—	50	1010	UKL1E102MHD
	1500	16×30.5	0.12	—	75	1270	UKL1E152MHD
	2200	16×35.5	0.14	—	110	1440	UKL1E222MHD
3300	18×40	0.16	—	165	1720	UKL1E332MHD	

For cut leads, formed leads or taped parts, please add the appropriate code after the size code (12th digit).
If there is no size code in the part number, please add size code "1" and then add the appropriate code.

UKL

■ Dimensions

Rated Voltage (V) (code)	Rated Capacitance (μF)	Case Size φD×L (mm)	tan δ	Leakage Current (μA)		Rated Ripple (mA _{rms}) (85°C/120Hz)	Part Number
				at 20°C after 1 minute	at 20°C after 2 minutes		
35 (1V)	47	8×11.5	0.08	3.29	—	190	UKL1V470MPD
	68	8×11.5	0.08	4.76	—	230	UKL1V680MPD
	100	10×12.5	0.08	7	—	300	UKL1V101MPD
	150	10×16	0.12	—	10.5	400	UKL1V151MPD
	220	10×20	0.12	—	15.4	440	UKL1V221MPD
	330	12.5×20	0.12	—	23.1	550	UKL1V331MHD
	470	12.5×25	0.12	—	32.9	680	UKL1V471MHD
	680	16×25	0.12	—	47.6	840	UKL1V681MHD
	1000	16×25	0.12	—	70	1100	UKL1V102MHD
	1500	16×35.5	0.12	—	105	1390	UKL1V152MHD
	2200	18×35.5	0.14	—	154	1580	UKL1V222MHD
50 (1H)	33	8×11.5	0.08	3.3	—	165	UKL1H330MPD
	47	8×11.5	0.08	4.7	—	190	UKL1H470MPD
	68	10×12.5	0.08	6.8	—	250	UKL1H680MPD
	100	10×16	0.10	—	10	320	UKL1H101MPD
	150	10×20	0.10	—	15	420	UKL1H151MPD
	220	12.5×20	0.10	—	22	490	UKL1H221MHD
	330	12.5×20	0.10	—	33	600	UKL1H331MHD
	470	16×25	0.10	—	47	760	UKL1H471MHD
	680	16×25	0.10	—	68	910	UKL1H681MHD
	1000	16×30.5	0.10	—	100	1140	UKL1H102MHD
	1500	18×40	0.10	—	150	1480	UKL1H152MHD
63 (1J)	22	8×11.5	0.07	2.772	—	115	UKL1J220MPD
	33	8×11.5	0.07	4.158	—	170	UKL1J330MPD
	47	10×12.5	0.07	5.922	—	200	UKL1J470MPD
	68	10×16	0.08	—	8.568	270	UKL1J680MPD
	100	10×20	0.08	—	12.6	330	UKL1J101MPD
	150	12.5×20	0.08	—	18.9	450	UKL1J151MHD
	220	12.5×20	0.08	—	27.72	550	UKL1J221MHD
	330	12.5×25	0.08	—	41.58	710	UKL1J331MHD
	470	16×25	0.08	—	59.22	850	UKL1J471MHD
	680	16×30.5	0.08	—	85.68	1050	UKL1J681MHD
	1000	18×35.5	0.08	—	126	1330	UKL1J102MHD
100 (2A)	10	8×11.5	0.07	2	—	90	UKL2A100MPD
	15	8×11.5	0.07	3	—	110	UKL2A150MPD
	22	10×12.5	0.07	4.4	—	136	UKL2A220MPD
	33	10×16	0.08	—	6.6	180	UKL2A330MPD
	47	10×20	0.08	—	9.4	220	UKL2A470MPD
	68	10×20	0.08	—	13.6	290	UKL2A680MPD
	100	12.5×20	0.08	—	20	370	UKL2A101MHD
	150	12.5×25	0.08	—	30	470	UKL2A151MHD
	220	16×25	0.08	—	44	580	UKL2A221MHD
	330	16×30.5	0.08	—	66	730	UKL2A331MHD
	470	18×35.5	0.08	—	94	910	UKL2A471MHD

For cut leads, formed leads or taped parts, please add the appropriate code after the size code (12th digit).
 If there is no size code in the part number, please add size code "1" and then add the appropriate code.

• For formed lead or taped product specifications and minimum order quantity, please refer to the Guidelines for Aluminum Electrolytic Capacitors.

ALUMINUM ELECTROLYTIC CAPACITORS

UAQ

Wide Temperature Range, Permissible Abnormal Voltage

- Improved safety feature for abnormally excessive voltage.
- High ripple current product.
- Compliant to the RoHS directive (2011/65/EU,(EU)2015/863).

Products which are scheduled to be discontinued.
Not recommended for new designs.



Specifications

Item	Performance Characteristics				
Category Temperature Range	-40 to +105°C				
Rated Voltage Range	200 - 400V				
Rated Capacitance Range	10 to 220µF				
Capacitance Tolerance	±20% at 120Hz, 20°C				
Leakage Current ※	After 1 minute's application of rated voltage at 20°C, leakage current is 0.04CV+100 (µA) or less.				
Tangent of loss angle (tan δ)	Rated voltage (V)	200	400	Measurement frequency:120Hz at 20°C	
	tan δ (max.)	0.15	0.15		
Stability at Low Temperature	Rated voltage (V)		200	400	Measurement frequency : 120Hz
	Impedance ratio (max.)		Z(-25°C) / Z(+20°C)	3	
Endurance	The specifications listed at right shall be met when the capacitors are restored to 20°C after D.C. bias plus rated ripple current is applied for 2000 hours at 105°C, the peak voltage shall not exceed the rated voltage.			Capacitance change	Within ±20% of the initial capacitance value
				tan δ	200% or less than the initial specified value
Shelf Life	After storing the capacitors under no load at 105°C for 1000 hours and then performing voltage treatment based on JIS C 5101-4 clause 4.1 at 20°C, they shall meet the specified values for the endurance characteristics listed above.			Leakage current	Less than or equal to the initial specified value
	The pressure relief vent will operate in normal conditions, with no dangerous conditions such as flames, ignitions or dispersion of pieces of the capacitor and / or case.				
Safety Performance	voltage (V)		Test conditions		
			Limited DC current		Test Voltage
	200		4A	300VDC and 375VDC	
	400		2A	500VDC and 600VDC	
Marking	Printed with white color letter on dark brown sleeve.				

※ I : Leakage Current (µA), C : Rated Capacitance (µF), V : Rated Voltage (V)

Radial Lead Type

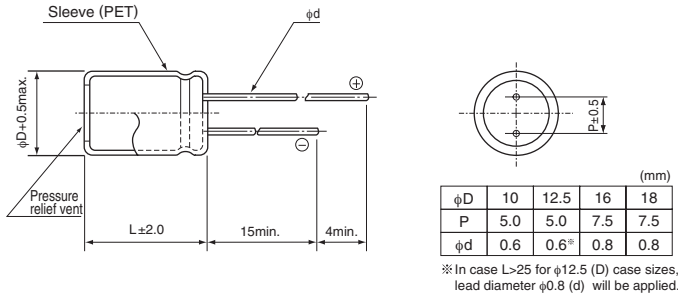

- Please refer to the Guidelines for Aluminum Electrolytic Capacitors for end seal configuration information.

Type numbering system (Example : 200V 100µF)

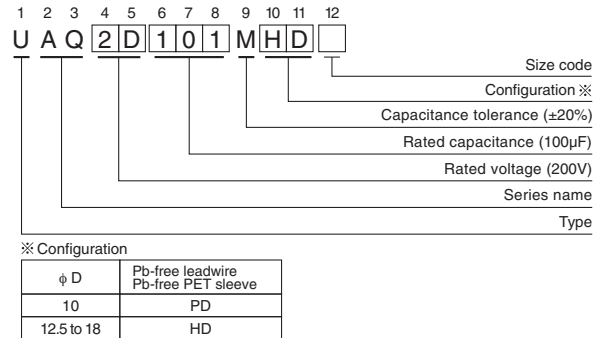

Frequency coefficient of rated ripple current

Frequency	50, 60Hz	120Hz	300Hz	1kHz	10kHz or more
Coefficient	0.80	1.00	1.25	1.40	1.60

● Dimension table in next page.

UAQ

■ Dimensions

Rated Voltage (V) (code)	Rated Capacitance (μF)	Case Size φD×L (mm)	tan δ	Leakage Current (μA) (at 20°C after 1 minute)	Rated Ripple (mA _{rms}) (105°C/120Hz)	Part Number
200 (2D)	22	10×20	0.15	276	120	UAQ2D220MPD
	33	10×25	0.15	364	160	UAQ2D330MPD
	33	12.5×20	0.15	364	160	UAQ2D330MHD6
	47	10×30.5	0.15	476	195	UAQ2D470MPD
	47	12.5×20	0.15	476	195	UAQ2D470MHD6
	56	12.5×25	0.15	548	210	UAQ2D560MHD
	68	12.5×25	0.15	644	250	UAQ2D680MHD
	82	12.5×30.5	0.15	756	285	UAQ2D820MHD
	82	16×20	0.15	756	285	UAQ2D820MHD6
	100	12.5×35.5	0.15	900	335	UAQ2D101MHD
	100	16×25	0.15	900	335	UAQ2D101MHD6
	100	18×20	0.15	900	335	UAQ2D101MHD3
	150	16×30.5	0.15	1300	435	UAQ2D151MHD
	150	18×25	0.15	1300	435	UAQ2D151MHD6
	180	16×35.5	0.15	1540	495	UAQ2D181MHD
	180	18×30.5	0.15	1540	495	UAQ2D181MHD6
220	18×35.5	0.15	1860	575	UAQ2D221MHD	
400 (2G)	10	12.5×20	0.15	260	100	UAQ2G100MHD
	22	12.5×30.5	0.15	452	145	UAQ2G220MHD
	22	16×20	0.15	452	145	UAQ2G220MHD6
	33	12.5×40	0.15	628	195	UAQ2G330MHD
	33	16×25	0.15	628	195	UAQ2G330MHD6
	33	18×20	0.15	628	195	UAQ2G330MHD3
	47	16×35.5	0.15	852	280	UAQ2G470MHD
	47	18×25	0.15	852	280	UAQ2G470MHD6
	56	16×35.5	0.15	996	320	UAQ2G560MHD
	56	18×30.5	0.15	996	320	UAQ2G560MHD6
	68	16×40	0.15	1188	350	UAQ2G680MHD
	68	18×35.5	0.15	1188	350	UAQ2G680MHD6
	82	18×40	0.15	1412	420	UAQ2G820MHD

For cut leads, formed leads or taped parts, please add the appropriate code after the size code (12th digit).
If there is no size code in the part number, please add size code "1" and then add the appropriate code.

- For formed lead or taped product specifications and minimum order quantity, please refer to the Guidelines for Aluminum Electrolytic Capacitors.

ALUMINUM ELECTROLYTIC CAPACITORS

UAS

Wide Temperature Range, Miniature Type Permissible Abnormal Voltage



- Improved safety feature for abnormally excessive voltage.
- High ripple current product.
- Compliant to the RoHS directive (2011/65/EU,(EU)2015/863).

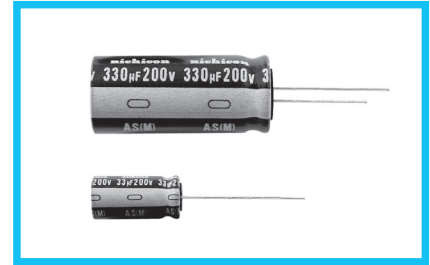

Specifications

Item	Performance Characteristics			
Category Temperature Range	-40 to +105°C			
Rated Voltage Range	200V, 400V			
Rated Capacitance Range	22 to 330μF			
Capacitance Tolerance	±20% at 120Hz, 20°C			
Leakage Current ※	After 1 minute's application of rated voltage at 20°C, leakage current is 0.04CV+100 (μA) or less.			
Tangent of loss angle (tan δ)	Rated voltage (V)	200	400	
	tan δ (max.)	0.15	0.15	
Measurement frequency:120Hz at 20°C				
Stability at Low Temperature	Rated voltage (V)		200	400
	Impedance ratio (max.)	Z(-25°C) / Z(+20°C)	3	8
		Z(-40°C) / Z(+20°C)	6	10
Measurement frequency : 120Hz				
Endurance	The specifications listed at right shall be met when the capacitors are restored to 20°C after D.C. bias plus rated ripple current is applied for 2000 hours at 105°C, the peak voltage shall not exceed the rated voltage.		Capacitance change	Within ±20% of the initial capacitance value
			tan δ	200% or less than the initial specified value
			Leakage current	Less than or equal to the initial specified value
Shelf Life	After leaving capacitors under no load at 105°C for 1000 hours they shall meet the specified values for the endurance characteristics listed above.			
Safety Performance	The pressure relief vent will operate in normal conditions, with no dangerous conditons such as flames, ignitions or dispersion of pieces of the capacitor and / or case.			
	voltage (V)	Test conditions		
		Limited DC current	Test Voltage	
		200	4A (5A : 330μF)	300VDC and 375VDC
400	2A (4A : 100μF or more)	500VDC and 600VDC		
Marking	Printed with white color letter on dark brown sleeve.			

※ I : Leakage Current (μA), C : Rated Capacitance (μF), V : Rated Voltage (V)

Radial Lead Type

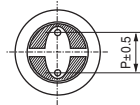
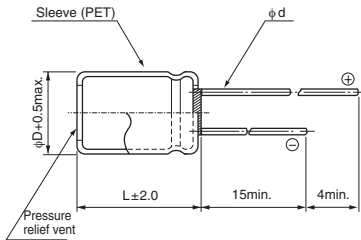

	(mm)			
φD	10	12.5	16	18
P	5.0	5.0	7.5	7.5
φd	0.6	0.6 ^①	0.8	0.8

※ In case L>25 for φ12.5 (D) case sizes, lead diameter φ0.8 (d) will be applied.

- Please refer to the Guidelines for Aluminum Electrolytic Capacitors for end seal configuration information.

Type numbering system (Example : 200V 220μF)

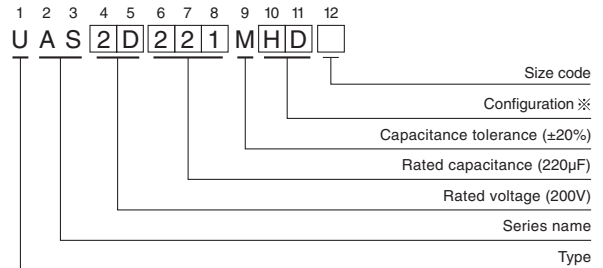

※ Configuration

φ D	Pb-free leadwire Pb-free PET sleeve
10	PD
12.5 to 18	HD

Frequency coefficient of rated ripple current

Frequency	50, 60Hz	120Hz	300Hz	1kHz	10kHz or more
Coefficient	0.80	1.00	1.25	1.40	1.60

● Dimension table in next page.

UAS

■ Dimensions

Rated Voltage (V) (code)	Rated Capacitance (μF)	Case Size φD×L (mm)	tan δ	Leakage Current (μA) (at 20°C after 1 minute)	Rated Ripple (mArms) (105°C/120Hz)	Part Number
200 (2D)	33	10×20	0.15	364	160	UAS2D330MPD
	47	10×25	0.15	476	195	UAS2D470MPD
	47	12.5×20	0.15	476	195	UAS2D470MHD6
	56	12.5×20	0.15	548	210	UAS2D560MHD
	68	12.5×25	0.15	644	320	UAS2D680MHD
	82	12.5×25	0.15	756	360	UAS2D820MHD
	100	12.5×30.5	0.15	900	430	UAS2D101MHD
	100	16×20	0.15	900	430	UAS2D101MHD6
	150	16×25	0.15	1300	460	UAS2D151MHD
	150	18×20	0.15	1300	460	UAS2D151MHD6
	180	16×30.5	0.15	1540	600	UAS2D181MHD
	180	18×25	0.15	1540	600	UAS2D181MHD6
	220	18×30.5	0.15	1860	710	UAS2D221MHD
	270	18×35.5	0.15	2260	890	UAS2D271MHD
	330	18×40	0.15	2740	910	UAS2D331MHD
400 (2G)	22	12.5×20	0.15	452	165	UAS2G220MHD
	27	12.5×25	0.15	532	200	UAS2G270MHD
	33	16×20	0.15	628	225	UAS2G330MHD
	39	16×25	0.15	724	255	UAS2G390MHD
	39	18×20	0.15	724	255	UAS2G390MHD6
	47	16×25	0.15	852	290	UAS2G470MHD
	47	18×20	0.15	852	280	UAS2G470MHD6
	56	16×30.5	0.15	996	340	UAS2G560MHD
	56	18×25	0.15	996	320	UAS2G560MHD6
	68	16×35.5	0.15	1188	385	UAS2G680MHD
	68	18×25	0.15	1188	360	UAS2G680MHD6
	82	16×40	0.15	1412	435	UAS2G820MHD
	82	18×30.5	0.15	1412	430	UAS2G820MHD6
	100	18×35.5	0.15	1700	490	UAS2G101MHD
	120	18×40	0.15	2020	540	UAS2G121MHD

For cut leads, formed leads or taped parts, please add the appropriate code after the size code (12th digit).
If there is no size code in the part number, please add size code "1" and then add the appropriate code.

- For formed lead or taped product specifications and minimum order quantity, please refer to the Guidelines for Aluminum Electrolytic Capacitors.

ALUMINUM ELECTROLYTIC CAPACITORS

UKA

For High Grade Audio Equipment,
Wide Temperature Range.



For Audio Use

UKA

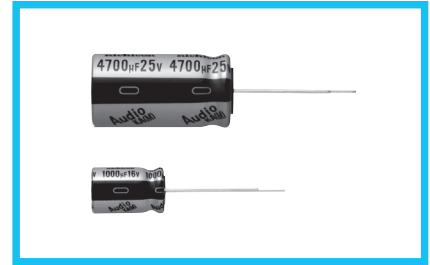

- 105°C high quality capacitors for audio equipment.
- Selected materials to create superior acoustic sound.
- Compliant to the RoHS directive (2011/65/EU, (EU)2015/863).
- AEC-Q200 Qualified. Please contact us for details.

Specifications

Item	Performance Characteristics							
Category Temperature Range	- 55 to +105°C							
Rated Voltage Range	6.3 to 50V							
Rated Capacitance Range	100 to 22000 µF							
Capacitance Tolerance	±20% at 120Hz, 20°C							
Leakage Current ※	After 1 minute's application of rated voltage at 20°C, leakage current is not more than 0.03CV (µA). After 2 minutes' application of rated voltage at 20°C, leakage current is not more than 0.01CV (µA).							
Tangent of loss angle (tan δ)	Rated voltage (V)	6.3 10 16 25 35 50						
	tan δ (max.)	0.30 0.26 0.22 0.18 0.16 0.14						
Measurement frequency : 120Hz at 20°C For capacitors with more than 1000µF, add 0.02 for every increase of 1000µF.								
Stability at Low Temperature	Rated voltage (V)	6.3 10 16 25 35 50						
	Impedance ratio (max.)	Z(-25°C) / Z(+20°C) : 5 4 3 2 2 2 Z(-40°C) / Z(+20°C) : 10 8 6 4 3 3						
Measurement frequency : 120Hz								
Endurance	The specifications listed at right shall be met when the capacitors are restored to 20°C after the rated voltage is applied for 2000 hours at 105°C.	<table border="1"> <tr> <td>Capacitance Change</td> <td>Within 20% of the initial capacitance value</td> </tr> <tr> <td>tan δ</td> <td>200% or less than the initial specified value</td> </tr> <tr> <td>Leakage current</td> <td>Less than or equal to the initial specified value</td> </tr> </table>	Capacitance Change	Within 20% of the initial capacitance value	tan δ	200% or less than the initial specified value	Leakage current	Less than or equal to the initial specified value
Capacitance Change	Within 20% of the initial capacitance value							
tan δ	200% or less than the initial specified value							
Leakage current	Less than or equal to the initial specified value							
Shelf Life	After storing the capacitors under no load at 105°C for 1000 hours and then performing voltage treatment based on JIS C 5101-4 clause 4.1 at 20°C, they shall meet the specified values for the endurance characteristics listed above.							
Marking	Printed with black color letter on pearl blue sleeve.							

※ I : Leakage Current (µA), C : Rated Capacitance (µF), V : Rated Voltage (V)

Radial Lead Type

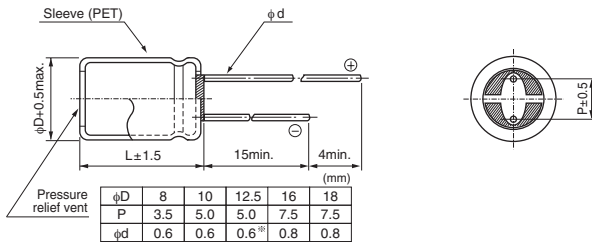

※ In case L>25 for φ12.5 (D) case sizes, lead diameter φ0.8 (d) will be applied.

- Please refer to the Guidelines for Aluminum Electrolytic Capacitors for end seal configuration information.

Type numbering system (Example : 16V 1000µF)

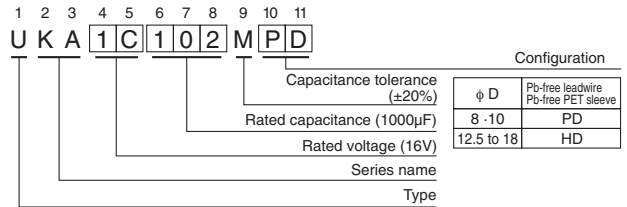

Frequency coefficient of rated ripple current

Cap. (µF)	Frequency	50Hz	120Hz	300Hz	1kHz	10kHz or more
100 to 470		0.80	1.00	1.23	1.34	1.50
1000 to 22000		0.85	1.00	1.10	1.13	1.15

● Dimension table in next page.

UKA

■ Dimensions

Rated Voltage (V) (code)	Rated Capacitance (μ F)	Case Size ϕ D \times L (mm)	tan δ	Leakage Current (μ A)		Rated Ripple (mArms) (105°C/120Hz)	Part Number
				at 20°C after 1 minute	at 20°C after 2 minutes		
6.3 (0J)	470	8 \times 11.5	0.30	88.83	29.61	270	UKA0J471MPD
	1000	10 \times 12.5	0.30	189	63	420	UKA0J102MPD
	2200	10 \times 20	0.32	415.8	138.6	710	UKA0J222MPD
	3300	12.5 \times 20	0.34	623.7	207.9	910	UKA0J332MHD
	4700	12.5 \times 25	0.36	888.3	296.1	1120	UKA0J472MHD
	6800	12.5 \times 35.5	0.40	1285.2	428.4	1360	UKA0J682MHD
	10000	12.5 \times 40	0.48	1890	630	1650	UKA0J103MHD
	15000	16 \times 35.5	0.58	2835	945	2010	UKA0J153MHD
	22000	18 \times 40	0.72	4158	1386	2350	UKA0J223MHD
10 (1A)	330	8 \times 11.5	0.26	99	33	240	UKA1A331MPD
	470	8 \times 11.5	0.26	141	47	280	UKA1A471MPD
	1000	10 \times 16	0.26	300	100	500	UKA1A102MPD
	2200	12.5 \times 20	0.28	660	220	810	UKA1A222MHD
	3300	12.5 \times 25	0.30	990	330	1050	UKA1A332MHD
	4700	12.5 \times 35.5	0.32	1410	470	1300	UKA1A472MHD
	6800	12.5 \times 40	0.36	2040	680	1570	UKA1A682MHD
	10000	16 \times 35.5	0.44	3000	1000	1890	UKA1A103MHD
	15000	18 \times 40	0.54	4500	1500	2400	UKA1A153MHD
16 (1C)	330	8 \times 11.5	0.22	158.4	52.8	265	UKA1C331MPD
	470	8 \times 11.5	0.22	225.6	75.2	315	UKA1C471MPD
	1000	10 \times 16	0.22	480	160	560	UKA1C102MPD
	2200	12.5 \times 20	0.24	1056	352	920	UKA1C222MHD
	3300	12.5 \times 30.5	0.26	1584	528	1270	UKA1C332MHD
	4700	12.5 \times 35.5	0.28	2256	752	1480	UKA1C472MHD
	6800	16 \times 30.5	0.32	3264	1088	1780	UKA1C682MHD
	10000	18 \times 35.5	0.40	4800	1600	2060	UKA1C103MHD
25 (1E)	220	8 \times 11.5	0.18	165	55	240	UKA1E221MPD
	330	8 \times 11.5	0.18	247.5	82.5	290	UKA1E331MPD
	470	10 \times 12.5	0.18	352.5	117.5	380	UKA1E471MPD
	1000	10 \times 20	0.18	750	250	680	UKA1E102MPD
	2200	12.5 \times 30.5	0.20	1650	550	1200	UKA1E222MHD
	3300	12.5 \times 35.5	0.22	2475	825	1400	UKA1E332MHD
	4700	16 \times 30.5	0.24	3525	1175	1710	UKA1E472MHD
	6800	18 \times 35.5	0.28	5100	1700	2040	UKA1E682MHD

For cut leads, formed leads or taped parts, please add the appropriate code after the size code (12th digit).

If there is no size code in the part number, please add size code "1" and then add the appropriate code.

UKA

■ Dimensions

Rated Voltage (V) (code)	Rated Capacitance (μ F)	Case Size ϕ D \times L (mm)	tan δ	Leakage Current (μ A)		Rated Ripple (mArms) (105°C/120Hz)	Part Number
				at 20°C after 1 minute	at 20°C after 2 minutes		
35 (1V)	220	8 \times 11.5	0.16	231	77	260	UKA1V221MPD
	330	10 \times 12.5	0.16	346.5	115.5	350	UKA1V331MPD
	470	10 \times 16	0.16	493.5	164.5	460	UKA1V471MPD
	1000	12.5 \times 25	0.16	1050	350	860	UKA1V102MHD
	2200	12.5 \times 40	0.18	2310	770	1260	UKA1V222MHD
	3300	16 \times 35.5	0.20	3465	1155	1610	UKA1V332MHD
	4700	18 \times 35.5	0.22	4935	1645	1910	UKA1V472MHD
50 (1H)	100	8 \times 11.5	0.14	150	50	190	UKA1H101MPD
	220	10 \times 12.5	0.14	330	110	300	UKA1H221MPD
	330	10 \times 16	0.14	495	165	410	UKA1H331MPD
	470	12.5 \times 20	0.14	705	235	530	UKA1H471MHD
	1000	12.5 \times 30.5	0.14	1500	500	1040	UKA1H102MHD
	2200	16 \times 35.5	0.16	3300	1100	1470	UKA1H222MHD
	3300	18 \times 35.5	0.18	4950	1650	1770	UKA1H332MHD

For cut leads, formed leads or taped parts, please add the appropriate code after the size code (12th digit).
If there is no size code in the part number, please add size code "1" and then add the appropriate code.

- For formed lead or taped product specifications and minimum order quantity, please refer to the Guidelines for Aluminum Electrolytic Capacitors.

ALUMINUM ELECTROLYTIC CAPACITORS

UKT For General Audio Equipment,
Wide Temperature Range.

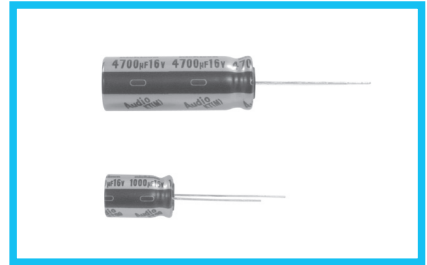
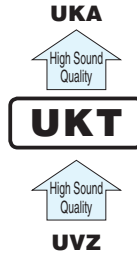

- 105°C standard for audio equipment.
- Compliant to the RoHS directive (2011/65/EU, (EU)2015/863).
- AEC-Q200 Qualified. Please contact us for details.

Valued marked with an ※ in the dimension table are scheduled to be discontinued and are not recommended for new designs.

Specifications

Item	Performance Characteristics							
Category Temperature Range	-55 to +105°C							
Rated Voltage Range	6.3 to 50V							
Rated Capacitance Range	100 to 22000µF							
Capacitance Tolerance	±20% at 120Hz, 20°C							
Leakage Current ※	After 1 minute's application of rated voltage at 20°C, leakage current is not more than 0.03CV (µA) . After 2 minutes' application of rated voltage at 20°C, leakage current is not more than 0.01CV (µA) .							
Tangent of loss angle (tan δ)	Rated voltage (V)	6.3	10	16	25	35	50	Measurement frequency : 120Hz at 20°C
	tan δ (max.)	0.30	0.26	0.22	0.18	0.16	0.14	
For capacitance of more than 1000µF, add 0.02 for every increase of 1000µF								
Stability at Low Temperature	Rated voltage (V)	6.3	10	16	25	35	50	Measurement frequency : 120Hz
	Impedance ratio (max.)	Z(-25°C) / Z(+20°C)	5	4	3	2	2	
Z(-40°C) / Z(+20°C)								
Endurance	The specifications listed at right shall be met when the capacitors are restored to 20°C after the rated voltage is applied for 1000 hours at 105°C.		Capacitance change		Within ±20% of the initial capacitance value			
			tan δ		200% or less than the initial specified value			
			Leakage current		Less than or equal to the initial specified value			
Shelf Life	After storing the capacitors under no load at 105°C for 1000 hours and then performing voltage treatment based on JIS C 5101-4 clause 4.1 at 20°C, they shall meet the specified values for the endurance characteristics listed above.							
Marking	Printed with black color letter on pearl blue sleeve.							

※ I : Leakage Current (µA), C : Rated Capacitance (µF), V : Rated Voltage (V)

Radial Lead Type

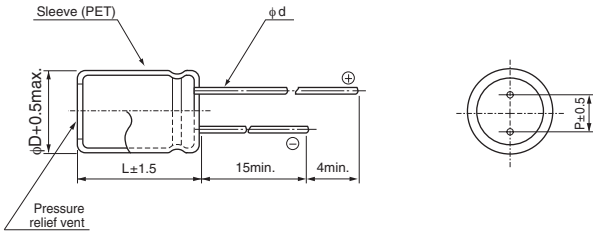

	(mm)				
φD	8	10	12.5	16	18
P	3.5	5.0	5.0	7.5	7.5
φd	0.6	0.6	0.6※	0.8	0.8

※ In case L>25 for φ12.5 (D) case sizes, lead diameter φ0.8 (d) will be applied.

- Please refer to the Guidelines for Aluminum Electrolytic Capacitors for end seal configuration information.

Frequency coefficient of rated ripple current

Cap. (µF)	Frequency				
100 to 470	50Hz	120Hz	300Hz	1kHz	10kHz or more
1000 to 22000	0.80	1.00	1.23	1.34	1.50
	0.85	1.00	1.10	1.13	1.15

Type numbering system (Example : 16V 1000µF)

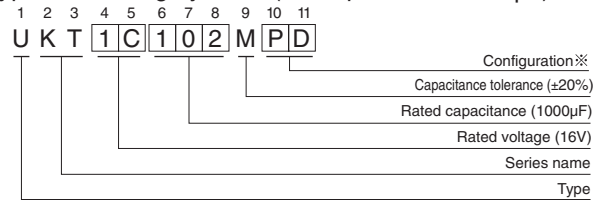

※ Configuration

φ D	Pb-free leadwire Pb-free PET sleeve
8 - 10	PD
12.5 to 18	HD

● Dimension table in next page.

UKT

■ Dimensions

Rated Voltage (V) (code)	Rated Capacitance (μ F)	Case Size ϕ D×L (mm)	tan δ	Leakage Current (μ A)		Rated Ripple (mArms) (105°C/120Hz)	Part Number
				at 20°C after 1 minute	at 20°C after 2 minutes		
6.3 (0J)	470	8×11.5	0.30	88.83	29.61	270	※UKT0J471MPD
	1000	10×12.5	0.30	189	63	420	※UKT0J102MPD
	2200	10×20	0.32	415.8	138.6	710	※UKT0J222MPD
	3300	12.5×20	0.34	623.7	207.9	910	※UKT0J332MHD
	4700	12.5×25	0.36	888.3	296.1	1120	※UKT0J472MHD
	6800	12.5×35.5	0.40	1285.2	428.4	1360	※UKT0J682MHD
	10000	12.5×40	0.48	1890	630	1650	※UKT0J103MHD
	15000	16×35.5	0.58	2835	945	2010	※UKT0J153MHD
10 (1A)	2200	18×40	0.72	4158	1386	2350	※UKT0J223MHD
	330	8×11.5	0.26	99	33	240	※UKT1A331MPD
	470	8×11.5	0.26	141	47	280	※UKT1A471MPD
	1000	10×16	0.26	300	100	500	※UKT1A102MPD
	2200	12.5×20	0.28	660	220	810	※UKT1A222MHD
	3300	12.5×25	0.30	990	330	1050	※UKT1A332MHD
	4700	12.5×35.5	0.32	1410	470	1300	※UKT1A472MHD
	6800	12.5×40	0.36	2040	680	1570	※UKT1A682MHD
16 (1C)	10000	16×35.5	0.44	3000	1000	1890	※UKT1A103MHD
	15000	18×40	0.54	4500	1500	2400	※UKT1A153MHD
	330	8×11.5	0.22	158.4	52.8	265	UKT1C331MPD
	470	8×11.5	0.22	225.6	75.2	315	UKT1C471MPD
	1000	10×16	0.22	480	160	560	UKT1C102MPD
	2200	12.5×20	0.24	1056	352	920	UKT1C222MHD
	3300	12.5×30.5	0.26	1584	528	1270	UKT1C332MHD
	4700	12.5×35.5	0.28	2256	752	1480	UKT1C472MHD
25 (1E)	6800	16×30.5	0.32	3264	1088	1780	UKT1C682MHD
	10000	18×35.5	0.40	4800	1600	2060	UKT1C103MHD
	220	8×11.5	0.18	165	55	240	UKT1E221MPD
	330	8×11.5	0.18	247.5	82.5	290	UKT1E331MPD
	470	10×12.5	0.18	352.5	117.5	380	UKT1E471MPD
	1000	10×20	0.18	750	250	680	UKT1E102MPD
	2200	12.5×30.5	0.20	1650	550	1200	UKT1E222MHD
	3300	12.5×35.5	0.22	2475	825	1400	UKT1E332MHD
35 (1V)	4700	16×30.5	0.24	3525	1175	1710	UKT1E472MHD
	6800	18×35.5	0.28	5100	1700	2040	UKT1E682MHD
	220	8×11.5	0.16	231	77	260	UKT1V221MPD
	330	10×12.5	0.16	346.5	115.5	350	UKT1V331MPD
	470	10×16	0.16	493.5	164.5	460	UKT1V471MPD
	1000	12.5×25	0.16	1050	350	860	UKT1V102MHD
	2200	12.5×40	0.18	2310	770	1260	UKT1V222MHD
	3300	16×35.5	0.20	3465	1155	1610	UKT1V332MHD
50 (1H)	4700	18×35.5	0.22	4935	1645	1910	UKT1V472MHD
	100	8×11.5	0.14	150	50	190	UKT1H101MPD
	220	10×12.5	0.14	330	110	300	UKT1H221MPD
	330	10×16	0.14	495	165	410	UKT1H331MPD
	470	12.5×20	0.14	705	235	530	UKT1H471MHD
	1000	12.5×30.5	0.14	1500	500	1040	UKT1H102MHD
	2200	16×35.5	0.16	3300	1100	1470	UKT1H222MHD
	3300	18×35.5	0.18	4950	1650	1770	UKT1H332MHD

For cut leads, formed leads or taped parts, please add the appropriate code after the size code (12th digit).
If there is no size code in the part number, please add size code "1" and then add the appropriate code.

• For formed lead or taped product specifications and minimum order quantity, please refer to the Guidelines for Aluminum Electrolytic Capacitors.

ALUMINUM ELECTROLYTIC CAPACITORS

UKW

Standard, For Audio Equipment



For Audio Use

- Realization of a harmonious balance of sound quality, made possible by the development of new electrolyte.
- Most suited for AV equipment.
- Compliant to the RoHS directive (2011/65/EU,(EU)2015/863).

UKW



Specifications

Item	Performance Characteristics																														
Category Temperature Range	-40 to +85°C																														
Rated Voltage Range	10 to 100V																														
Rated Capacitance Range	33 to 15000µF																														
Capacitance Tolerance	±20% at 120Hz, 20°C																														
Leakage Current ※	After 1 minute's application of rated voltage at 20°C, leakage current is not more than 0.03 CV (µA) . After 2 minutes' application of rated voltage at 20°C, leakage current is not more than 0.01 CV (µA) .																														
Tangent of loss angle (tan δ)	<table border="1"> <tr> <td>Rated voltage (V)</td> <td>6.3</td> <td>10</td> <td>16</td> <td>25</td> <td>35</td> <td>50</td> <td>63</td> <td>100</td> </tr> <tr> <td>tan δ (max.)</td> <td>0.28</td> <td>0.24</td> <td>0.20</td> <td>0.16</td> <td>0.14</td> <td>0.12</td> <td>0.10</td> <td>0.08</td> </tr> </table> <p>Measurement frequency : 120Hz at 20°C For capacitance of more than 1000µF, add 0.02 for every increase of 1000µF.</p>	Rated voltage (V)	6.3	10	16	25	35	50	63	100	tan δ (max.)	0.28	0.24	0.20	0.16	0.14	0.12	0.10	0.08												
Rated voltage (V)	6.3	10	16	25	35	50	63	100																							
tan δ (max.)	0.28	0.24	0.20	0.16	0.14	0.12	0.10	0.08																							
Stability at Low Temperature	<table border="1"> <tr> <td colspan="2">Rated voltage (V)</td> <td>6.3</td> <td>10</td> <td>16</td> <td>25</td> <td>35</td> <td>50</td> <td>63</td> <td>100</td> </tr> <tr> <td rowspan="2">Impedance ratio (max.)</td> <td>Z(-25°C) / Z(+20°C)</td> <td>5</td> <td>4</td> <td>3</td> <td>2</td> <td>2</td> <td>2</td> <td>2</td> <td>2</td> </tr> <tr> <td>Z(-40°C) / Z(+20°C)</td> <td>12</td> <td>10</td> <td>8</td> <td>5</td> <td>4</td> <td>3</td> <td>3</td> <td>3</td> </tr> </table> <p>Measurement frequency : 120Hz</p>	Rated voltage (V)		6.3	10	16	25	35	50	63	100	Impedance ratio (max.)	Z(-25°C) / Z(+20°C)	5	4	3	2	2	2	2	2	Z(-40°C) / Z(+20°C)	12	10	8	5	4	3	3	3	
Rated voltage (V)		6.3	10	16	25	35	50	63	100																						
Impedance ratio (max.)	Z(-25°C) / Z(+20°C)	5	4	3	2	2	2	2	2																						
	Z(-40°C) / Z(+20°C)	12	10	8	5	4	3	3	3																						
Endurance	The specifications listed at right shall be met when the capacitors are restored to 20°C after the rated voltage is applied for 2000 hours at 85°C.	<table border="1"> <tr> <td>Capacitance change</td> <td>Within ±20% of the initial capacitance value</td> </tr> <tr> <td>tan δ</td> <td>200% or less than the initial specified value</td> </tr> <tr> <td>Leakage current</td> <td>Less than or equal to the initial specified value</td> </tr> </table>	Capacitance change	Within ±20% of the initial capacitance value	tan δ	200% or less than the initial specified value	Leakage current	Less than or equal to the initial specified value																							
Capacitance change	Within ±20% of the initial capacitance value																														
tan δ	200% or less than the initial specified value																														
Leakage current	Less than or equal to the initial specified value																														
Shelf Life	After storing the capacitors under no load at 85°C for 1000 hours and then performing voltage treatment based on JIS C 5101-4 clause 4.1 at 20°C, they shall meet the specified values for the endurance characteristics listed above.																														
Marking	Printed with gold color letter on black sleeve.																														

※ I : Leakage Current (µA), C : Rated Capacitance (µF), V : Rated Voltage (V)

Radial Lead Type

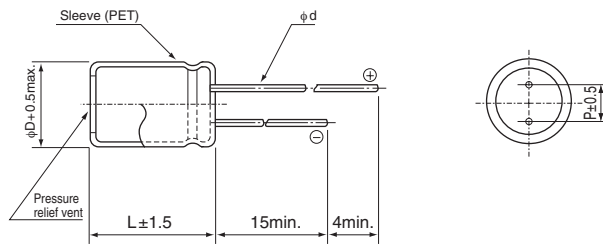

	(mm)				
φD	8	10	12.5	16	18
P	3.5	5.0	5.0	7.5	7.5
φd	0.6	0.6	0.6	0.8	0.8

Type numbering system (Example : 10V 1000µF)

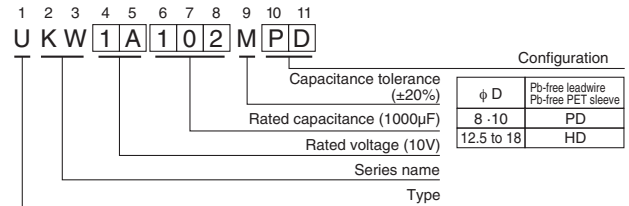

● Please refer to the Guidelines for Aluminum Electrolytic Capacitors for end seal configuration information.

Frequency coefficient of rated ripple current

Cap.(µF)	Frequency					
	50Hz	120Hz	300Hz	1kHz	10kHz or more	
33 to 47	0.75	1.00	1.35	1.57	2.00	
100 to 470	0.80	1.00	1.23	1.34	1.50	
1000 to 15000	0.85	1.00	1.10	1.13	1.15	

● Dimension table in next page.

UKW

■ Dimensions

Rated Voltage (V) (code)	Rated Capacitance (μ F)	Case Size ϕ D \times L (mm)	tan δ	Leakage Current (μ A)		Rated Ripple (mArms) (85°C/120Hz)	Part Number
				at 20°C after 1 minute	at 20°C after 2 minutes		
10 (1A)	1000	10 \times 12.5	0.24	300	100	630	UKW1A102MPD
	2200	10 \times 20	0.26	660	220	1050	UKW1A222MPD
	3300	12.5 \times 20	0.28	990	330	1420	UKW1A332MHD
	4700	12.5 \times 25	0.30	1410	470	1800	UKW1A472MHD
	6800	16 \times 25	0.34	2040	680	2150	UKW1A682MHD
	10000	16 \times 35.5	0.42	3000	1000	2500	UKW1A103MHD
	15000	18 \times 35.5	0.52	4500	1500	2720	UKW1A153MHD
16 (1C)	330	8 \times 11.5	0.20	158.4	52.8	360	UKW1C331MPD
	470	8 \times 11.5	0.20	225.6	75.2	420	UKW1C471MPD
	1000	10 \times 16	0.20	480	160	770	UKW1C102MPD
	2200	12.5 \times 20	0.22	1056	352	1250	UKW1C222MHD
	3300	12.5 \times 25	0.24	1584	528	1700	UKW1C332MHD
	4700	16 \times 25	0.26	2256	752	2100	UKW1C472MHD
	6800	16 \times 35.5	0.30	3264	1088	2500	UKW1C682MHD
	10000	18 \times 35.5	0.38	4800	1600	2640	UKW1C103MHD
25 (1E)	220	8 \times 11.5	0.16	165	55	320	UKW1E221MPD
	330	10 \times 12.5	0.16	247.5	82.5	420	UKW1E331MPD
	470	10 \times 12.5	0.16	352.5	117.5	530	UKW1E471MPD
	1000	10 \times 20	0.16	750	250	950	UKW1E102MPD
	2200	12.5 \times 25	0.18	1650	550	1550	UKW1E222MHD
	3300	16 \times 25	0.20	2475	825	1950	UKW1E332MHD
	4700	16 \times 30.5	0.22	3525	1175	2360	UKW1E472MHD
	6800	18 \times 35.5	0.26	5100	1700	2590	UKW1E682MHD
35 (1V)	220	10 \times 12.5	0.14	231	77	370	UKW1V221MPD
	330	10 \times 12.5	0.14	346.5	115.5	470	UKW1V331MPD
	470	10 \times 16	0.14	493.5	164.5	630	UKW1V471MPD
	1000	12.5 \times 20	0.14	1050	350	1100	UKW1V102MHD
	2200	16 \times 25	0.16	2310	770	1800	UKW1V222MHD
	3300	16 \times 35.5	0.18	3465	1155	2220	UKW1V332MHD
	4700	18 \times 35.5	0.20	4935	1645	2490	UKW1V472MHD

For cut leads, formed leads or taped parts, please add the appropriate code after the size code (12th digit).
If there is no size code in the part number, please add size code "1" and then add the appropriate code.

UKW

■ Dimensions

Rated Voltage (V) (code)	Rated Capacitance (μ F)	Case Size ϕ D \times L (mm)	tan δ	Leakage Current (μ A)		Rated Ripple (mArms) (85°C/120Hz)	Part Number
				at 20°C after 1 minute	at 20°C after 2 minutes		
50 (1H)	100	8 \times 11.5	0.12	150	50	250	UKW1H101MPD
	220	10 \times 12.5	0.12	330	110	410	UKW1H221MPD
	330	10 \times 16	0.12	495	165	570	UKW1H331MPD
	470	12.5 \times 20	0.12	705	235	760	UKW1H471MHD
	1000	12.5 \times 25	0.12	1500	500	1300	UKW1H102MHD
	2200	16 \times 35.5	0.14	3300	1100	2090	UKW1H222MHD
	3300	18 \times 35.5	0.16	4950	1650	2360	UKW1H332MHD
63 (1J)	100	10 \times 12.5	0.10	189	63	300	UKW1J101MPD
	220	10 \times 16	0.10	415.8	138.6	470	UKW1J221MPD
	330	10 \times 20	0.10	623.7	207.9	650	UKW1J331MPD
	470	12.5 \times 20	0.10	888.3	296.1	880	UKW1J471MHD
	1000	16 \times 25	0.10	1890	630	1300	UKW1J102MHD
	2200	18 \times 35.5	0.12	4158	1386	2200	UKW1J222MHD
100 (2A)	33	8 \times 11.5	0.08	99	33	160	UKW2A330MPD
	47	10 \times 12.5	0.08	141	47	210	UKW2A470MPD
	100	10 \times 20	0.08	300	100	350	UKW2A101MPD
	220	12.5 \times 25	0.08	660	220	600	UKW2A221MHD
	330	12.5 \times 25	0.08	990	330	750	UKW2A331MHD
	470	16 \times 25	0.08	1410	470	1000	UKW2A471MHD
	1000	18 \times 40	0.08	3000	1000	1370	UKW2A102MHD

For cut leads, formed leads or taped parts, please add the appropriate code after the size code (12th digit).
If there is no size code in the part number, please add size code "1" and then add the appropriate code.

- For formed lead or taped product specifications and minimum order quantity, please refer to the Guidelines for Aluminum Electrolytic Capacitors.

ALUMINUM ELECTROLYTIC CAPACITORS

UFW

Standard, For Audio Equipment



- Compliant to the RoHS directive (2011/65/EU,(EU)2015/863).

Valued marked with an ※ in the dimension table are scheduled to be discontinued and are not recommended for new designs.

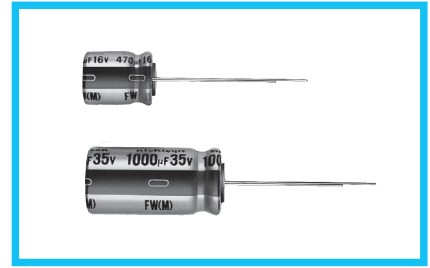
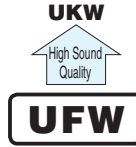

Specifications

Item	Performance Characteristics									
Category Temperature Range	-40 to +85°C									
Rated Voltage Range	6.3 to 100V									
Rated Capacitance Range	33 to 22000µF									
Capacitance Tolerance	±20% at 120Hz, 20°C									
Leakage Current ※	After 1 minute's application of rated voltage at 20°C, leakage current is not more than 0.03 CV (µA) . After 2 minutes' application of rated voltage at 20°C, leakage current is not more than 0.01 CV (µA).									
Tangent of loss angle (tan δ)	Rated voltage (V)	6.3	10	16	25	35	50	63	100	Measurement frequency : 120Hz at 20°C
	tan δ (max.)	0.28	0.24	0.20	0.16	0.14	0.12	0.10	0.08	
For capacitance of more than 1000µF, add 0.02 for every increase of 1000µF.										
Stability at Low Temperature	Measurement frequency : 120Hz									
	Rated voltage (V)	6.3	10	16	25	35	50	63	100	
Impedance ratio (max.)	Z(-25°C) / Z(+20°C)	5	4	3	2	2	2	2	2	
	Z(-40°C) / Z(+20°C)	12	10	8	5	4	3	3	3	
Endurance	The specifications listed at right shall be met when the capacitors are restored to 20°C after the rated voltage is applied for 2000 hours at 85°C.									
	Capacitance change	Within ±20% of the initial capacitance value								
	tan δ	200% or less than the initial specified value								
Shelf Life	After storing the capacitors under no load at 85°C for 1000 hours and then performing voltage treatment based on JIS C 5101-4 clause 4.1 at 20°C, they shall meet the specified values for the endurance characteristics listed above.									
	Leakage current	Less than or equal to the initial specified value								
Marking	Printed with black color letter on Gold sleeve.									

※ I : Leakage Current (µA), C : Rated Capacitance (µF), V : Rated Voltage (V)

Radial Lead Type

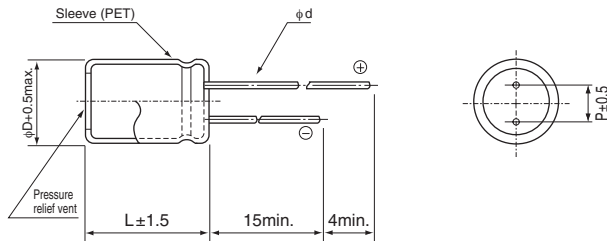

	(mm)				
φD	8	10	12.5	16	18
P	3.5	5.0	5.0	7.5	7.5
φd	0.6	0.6	0.6	0.8	0.8

Type numbering system (Example : 16V 330µF)

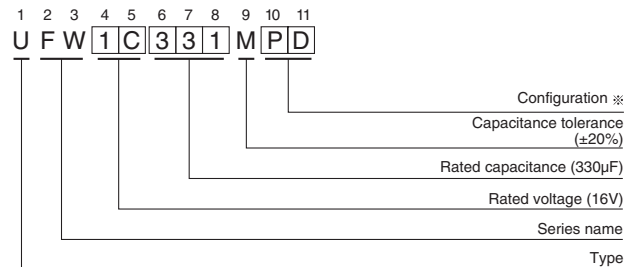

※ Configuration

φ D	Pb-free leadwire Pb-free PET sleeve
8 -10	PD
12.5 to 18	HD

- Please refer to the Guidelines for Aluminum Electrolytic Capacitors for end seal configuration information.

Frequency coefficient of rated ripple current

Cap.(µF)	Frequency				
33 to 47	50Hz	120Hz	300Hz	1kHz	10kHz or more
100 to 470	0.75	1.00	1.35	1.57	2.00
1000 to 22000	0.80	1.00	1.23	1.34	1.50
	0.85	1.00	1.10	1.13	1.15

●Dimension table in next page.

UFW

■ Dimensions

Rated Voltage (V) (code)	Rated Capacitance (μ F)	Case Size ϕ D \times L (mm)	tan δ	Leakage Current (μ A)		Rated Ripple (mArms) (85°C/120Hz)	Part Number
				at 20°C after 1 minute	at 20°C after 2 minutes		
6.3 (0J)	1000	8 \times 11.5	0.28	189	63	530	※UFW0J102MPD
	2200	10 \times 20	0.30	415.8	138.6	980	※UFW0J222MPD
	3300	10 \times 20	0.32	623.7	207.9	1170	※UFW0J332MPD
	4700	12.5 \times 20	0.34	888.3	296.1	1350	※UFW0J472MHD
	6800	12.5 \times 25	0.38	1285.2	428.4	1600	※UFW0J682MHD
	10000	16 \times 25	0.46	1890	630	2000	※UFW0J103MHD
	15000	16 \times 35.5	0.56	2835	945	2550	※UFW0J153MHD
	22000	18 \times 40	0.70	4158	1386	3200	※UFW0J223MHD
10 (1A)	1000	10 \times 12.5	0.24	300	100	630	※UFW1A102MPD
	2200	10 \times 20	0.26	660	220	1050	※UFW1A222MPD
	3300	12.5 \times 20	0.28	990	330	1420	※UFW1A332MHD
	4700	12.5 \times 25	0.30	1410	470	1800	※UFW1A472MHD
	6800	16 \times 25	0.34	2040	680	2150	※UFW1A682MHD
	10000	16 \times 35.5	0.42	3000	1000	2500	※UFW1A103MHD
	15000	18 \times 35.5	0.52	4500	1500	2720	※UFW1A153MHD
16 (1C)	330	8 \times 11.5	0.20	158.4	52.8	360	UFW1C331MPD
	470	8 \times 11.5	0.20	225.6	75.2	420	UFW1C471MPD
	1000	10 \times 16	0.20	480	160	770	UFW1C102MPD
	2200	12.5 \times 20	0.22	1056	352	1250	UFW1C222MHD
	3300	12.5 \times 25	0.24	1584	528	1700	UFW1C332MHD
	4700	16 \times 25	0.26	2256	752	2100	UFW1C472MHD
	6800	16 \times 35.5	0.30	3264	1088	2500	UFW1C682MHD
	10000	18 \times 35.5	0.38	4800	1600	2640	UFW1C103MHD
25 (1E)	220	8 \times 11.5	0.16	165	55	320	UFW1E221MPD
	330	10 \times 12.5	0.16	247.5	82.5	420	UFW1E331MPD
	470	10 \times 12.5	0.16	352.5	117.5	530	UFW1E471MPD
	1000	10 \times 20	0.16	750	250	950	UFW1E102MPD
	2200	12.5 \times 25	0.18	1650	550	1550	UFW1E222MHD
	3300	16 \times 25	0.20	2475	825	1950	UFW1E332MHD
	4700	16 \times 30.5	0.22	3525	1175	2360	UFW1E472MHD
	6800	18 \times 35.5	0.26	5100	1700	2590	UFW1E682MHD
35 (1V)	220	10 \times 12.5	0.14	231	77	370	UFW1V221MPD
	330	10 \times 12.5	0.14	346.5	115.5	470	UFW1V331MPD
	470	10 \times 16	0.14	493.5	164.5	630	UFW1V471MPD
	1000	12.5 \times 20	0.14	1050	350	1100	UFW1V102MHD
	2200	16 \times 25	0.16	2310	770	1800	UFW1V222MHD
	3300	16 \times 35.5	0.18	3465	1155	2220	UFW1V332MHD
	4700	18 \times 35.5	0.20	4935	1645	2490	UFW1V472MHD

For cut leads, formed leads or taped parts, please add the appropriate code after the size code (12th digit).
If there is no size code in the part number, please add size code "1" and then add the appropriate code.

UFW

■ Dimensions

Rated Voltage (V) (code)	Rated Capacitance (μ F)	Case Size ϕ D \times L (mm)	tan δ	Leakage Current (μ A)		Rated Ripple (mArms) (85°C/120Hz)	Part Number
				at 20°C after 1 minute	at 20°C after 2 minutes		
50 (1H)	100	8 \times 11.5	0.12	150	50	250	UFW1H101MPD
	220	10 \times 12.5	0.12	330	110	410	UFW1H221MPD
	330	10 \times 16	0.12	495	165	570	UFW1H331MPD
	470	12.5 \times 20	0.12	705	235	760	UFW1H471MHD
	1000	12.5 \times 25	0.12	1500	500	1300	UFW1H102MHD
	2200	16 \times 35.5	0.14	3300	1100	2090	UFW1H222MHD
	3300	18 \times 35.5	0.16	4950	1650	2360	UFW1H332MHD
63 (1J)	100	10 \times 12.5	0.10	189	63	300	UFW1J101MPD
	220	10 \times 16	0.10	415.8	138.6	470	UFW1J221MPD
	330	10 \times 20	0.10	623.7	207.9	650	UFW1J331MPD
	470	12.5 \times 20	0.10	888.3	296.1	880	UFW1J471MHD
	1000	16 \times 25	0.10	1890	630	1300	UFW1J102MHD
	2200	18 \times 35.5	0.12	4158	1386	2200	UFW1J222MHD
100 (2A)	33	8 \times 11.5	0.08	99	33	160	UFW2A330MPD
	47	10 \times 12.5	0.08	141	47	210	UFW2A470MPD
	100	10 \times 20	0.08	300	100	350	UFW2A101MPD
	220	12.5 \times 25	0.08	660	220	600	UFW2A221MHD
	330	12.5 \times 25	0.08	990	330	750	UFW2A331MHD
	470	16 \times 25	0.08	1410	470	1000	UFW2A471MHD
	1000	18 \times 40	0.08	3000	1000	1370	UFW2A102MHD

For cut leads, formed leads or taped parts, please add the appropriate code after the size code (12th digit).
If there is no size code in the part number, please add size code "1" and then add the appropriate code.

- For formed lead or taped product specifications and minimum order quantity, please refer to the Guidelines for Aluminum Electrolytic Capacitors.

ALUMINUM ELECTROLYTIC CAPACITORS



Bi-Polarized, For Audio Equipment



- Bi-polarized “nichicon MUSE” acoustic series.
- Suited for audio signal circuits.
- Compliant to the RoHS directive (2011/65/EU,(EU)2015/863).

Valued marked with an ※ in the dimension table are scheduled to be discontinued and are not recommended for new designs.

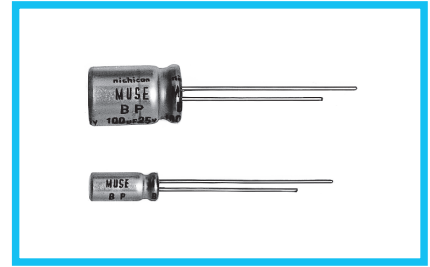

Specifications

Item	Performance Characteristics							
Category Temperature Range	-40 to +85°C							
Rated Voltage Range	6.3 to 50V							
Rated Capacitance Range	10 to 1000μF							
Capacitance Tolerance	±20% at 120Hz, 20°C							
Leakage Current ※	After 1 minute's application of rated voltage at 20°C, leakage current is not more than 0.03CV (μA).							
Tangent of loss angle (tan δ)	Measurement frequency : 120Hz at 20°C							
	Rated voltage (V)	6.3	10	16	25	35	50	
	tan δ (max.)	0.24	0.20	0.16	0.16	0.14	0.12	
Stability at Low Temperature	Measurement frequency : 120Hz							
	Rated voltage (V)		6.3	10	16	25	35	50
	Impedance ratio (max.)	Z(-25°C) / Z(+20°C)		4	3	2	2	2
Z(-40°C) / Z(+20°C)		8	6	4	4	4		
Endurance	The specifications listed at right shall be met when the capacitors are restored to 20°C after the rated voltage is applied for 1000 hours at 85°C with the polarity inverted every 250 hours.						Capacitance change	Within ±20% of the initial capacitance value
							tan δ	150% or less than the initial specified value
							Leakage current	Less than or equal to the initial specified value
Shelf Life	After storing the capacitors under no load at 85°C for 1000 hours and then performing voltage treatment based on JIS C 5101-4 clause 4.1 at 20°C, they shall meet the specified values for the endurance characteristics listed above.							
Marking	Printed with black color letter on clear green sleeve.							

※ I : Leakage Current (μA), C : Rated Capacitance (μF), V : Rated Voltage (V)

Radial Lead Type

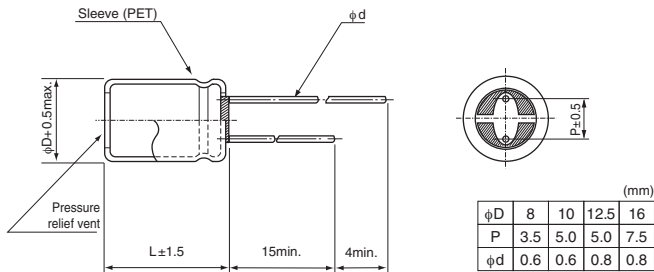

Type numbering system (Example : 16V 47μF)

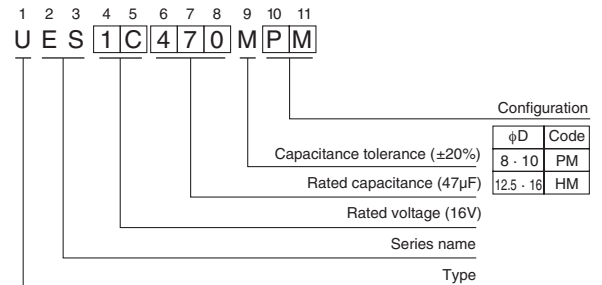

- Please refer to the Guidelines for Aluminum Electrolytic Capacitors for end seal configuration information.

● Dimension table in next page.

UES

■ Dimensions

Rated Voltage (V) (code)	Rated Capacitance (μ F)	Case Size ϕ D×L (mm)	$\tan \delta$	Leakage Current (μ A) (at 20°C after 1 minute)	Part Number
6.3 (0J)	100	8×11.5	0.24	18.9	※UES0J101MPM
	220	10×12.5	0.24	41.58	※UES0J221MPM
	330	10×16	0.24	62.37	※UES0J331MPM
	470	10×20	0.24	88.83	※UES0J471MPM
	1000	12.5×25	0.24	189	※UES0J102MHM
10 (1A)	100	10×12.5	0.20	30	※UES1A101MPM
	220	10×16	0.20	66	※UES1A221MPM
	330	10×20	0.20	99	※UES1A331MPM
	470	12.5×20	0.20	141	※UES1A471MHM
	1000	16×25	0.20	300	※UES1A102MHM
16 (1C)	47	8×11.5	0.16	22.56	UES1C470MPM
	100	10×12.5	0.16	48	UES1C101MPM
	220	10×20	0.16	105.6	UES1C221MPM
	330	12.5×20	0.16	158.4	UES1C331MHM
	470	12.5×25	0.16	225.6	UES1C471MHM
	1000	16×25	0.16	480	UES1C102MHM
25 (1E)	33	8×11.5	0.16	24.75	UES1E330MPM
	47	10×12.5	0.16	35.25	UES1E470MPM
	100	10×16	0.16	75	UES1E101MPM
	220	12.5×25	0.16	165	UES1E221MHM
	330	12.5×25	0.16	247.5	UES1E331MHM
	470	16×25	0.16	352.5	UES1E471MHM
	1000	16×30.5	0.16	750	UES1E102MHM
35 (1V)	22	8×11.5	0.14	23.1	UES1V220MPM
	33	10×12.5	0.14	34.65	UES1V330MPM
	47	10×12.5	0.14	49.35	UES1V470MPM
	100	10×20	0.14	105	UES1V101MPM
	220	12.5×25	0.14	231	UES1V221MHM
	330	16×25	0.14	346.5	UES1V331MHM
	470	16×25	0.14	493.5	UES1V471MHM
50 (1H)	10	8×11.5	0.12	15	UES1H100MPM
	22	10×12.5	0.12	33	UES1H220MPM
	33	10×16	0.12	49.5	UES1H330MPM
	47	10×20	0.12	70.5	UES1H470MPM
	100	12.5×25	0.12	150	UES1H101MHM
	220	16×25	0.12	330	UES1H221MHM
	330	16×30.5	0.12	495	UES1H331MHM

For cut leads, formed leads or taped parts, please add the appropriate code after the size code (12th digit).
If there is no size code in the part number, please add size code "1" and then add the appropriate code.

- For formed lead or taped product specifications and minimum order quantity, please refer to the Guidelines for Aluminum Electrolytic Capacitors.

ALUMINUM ELECTROLYTIC CAPACITORS

UDB

Bi-Polarized, For Speaker Network



- Bi-polarized series.
- Designed specifically for crossover networks in Hi-Fi sound systems.
- Compliant to the RoHS directive (2011/65/EU,(EU)2015/863).

Products which are scheduled to be discontinued.
Not recommended for new designs.

Specifications

Item	Performance Characteristics
Category Temperature Range	-40 to +85°C
Rated Voltage Range	50V
Rated Capacitance Tolerance	±20% at 1kHz
Leakage Current (After 5 minutes' application of rated voltage at 20°C)※	Leakage current is not more than 0.03CV or 3 (µA), whichever is greater.
Tangent of loss angle (tan δ) (1 kHz) (5 kHz)	0.10 or less 0.15 or less
Allowable Continuous Current (8Ω - f _c)	Value in table or less
Marking	Printed with white color letter on black sleeve.

※ C : Rated Capacitance (µF), V : Rated Voltage (V)

Radial Lead Type

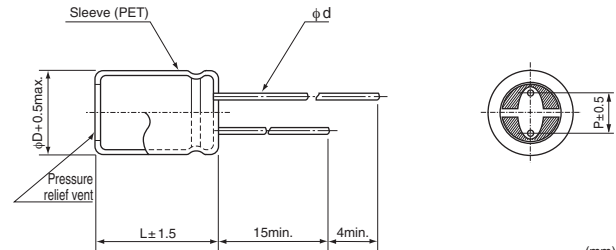

	(mm)				
φD	8	10	12.5	16	18
P	3.5	5.0	5.0	7.5	7.5
φd	0.8	0.8	0.8	0.8	0.8

- Please refer to the Guidelines for Aluminum Electrolytic Capacitors for end seal configuration information.

Type numbering system (Example : UDB 50V 10µF)

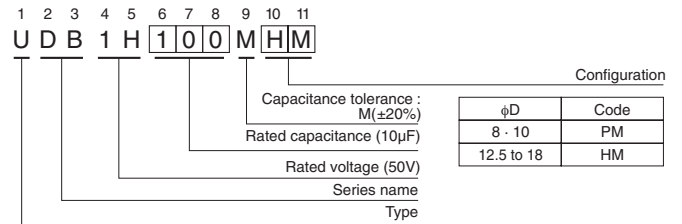

Dimensions

Rated Voltage (V) (code)	Rated Capacitance (µF)	Case Size φD×L (mm)	tan δ		Leakage Current (µA) (at 20°C after 5 minutes)	Allowable Continuous Current (8Ω - f _c)		Part Number
			1kHz	5kHz		Frequency (Hz)	Rated ripple (mArms)	
50 (1H)	1	8×11.5	0.10	0.15	3	20k	205	UDB1H010MPM
	1.5	8×11.5	0.10	0.15	3	13k	245	UDB1H1R5MPM
	2.2	10×12.5	0.10	0.15	3.3	9k	320	UDB1H2R2MPM
	3.3	10×16	0.10	0.15	4.95	6k	400	UDB1H3R3MPM
	4.7	10×20	0.10	0.15	7.05	4.2k	480	UDB1H4R7MPM
	6.8	12.5×20	0.10	0.15	10.2	2.9k	540	UDB1H6R8MHM
	10	12.5×25	0.10	0.15	15	2k	600	UDB1H100MHM
	15	12.5×25	0.10	0.15	22.5	1.3k	660	UDB1H150MHM
	22	16×25	0.10	0.15	33	900	740	UDB1H220MHM
	33	16×30.5	0.10	0.15	49.5	600	800	UDB1H330MHM
47	18×35.5	0.10	0.15	70.5	420	1020	UDB1H470MHM	

For cut leads, formed leads or taped parts, please add the appropriate code after the size code (12th digit).
If there is no size code in the part number, please add size code "1" and then add the appropriate code.

- For formed lead or taped product specifications and minimum order quantity, please refer to the Guidelines for Aluminum Electrolytic Capacitors.