

Posi-R[®]
Positive Thermistors

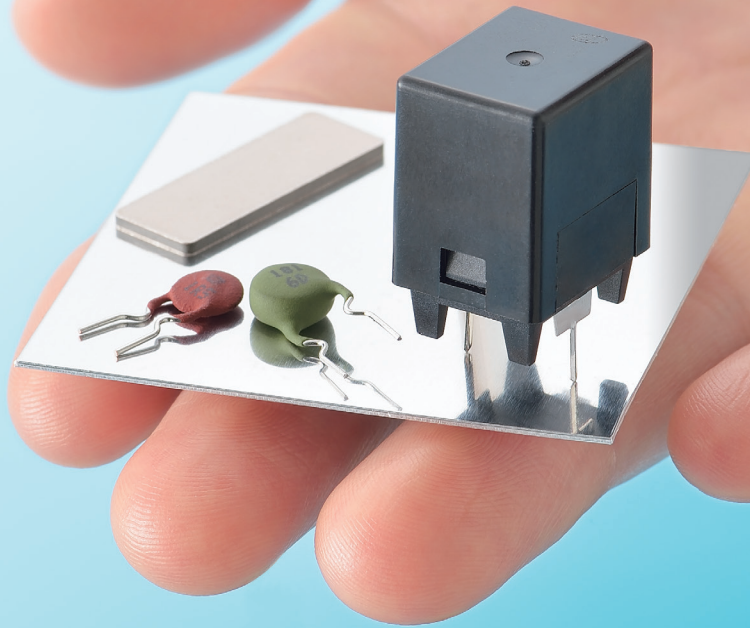

**"Posi-R[®]" is your best choice
for quality and reliability.**

Reliable



High performance achieved through high reliability.

The Nichicon Group has a proven track record in developing products that are both highly reliable and are high performance. These products include aluminum electrolytic capacitors, film capacitors, and circuit products. Among these are the company's positive thermistors, made at Nichicon Kameoka Corporation. Sold under the brand name Posi-R, these positive thermistors stand up to repeated use and offer rapid increase in resistive value in response to temperature rise.

There are three main types of positive thermistor: for heaters, for in-rush current limitation, and for overcurrent protection. Positive thermistors for heaters heat up quickly and evenly until they reach the desired temperature. Positive thermistors for in-rush current limitation come in two types: space-efficient lead type and case type, with both capable of handling continuous current better than cement resistors. The third type is for overcurrent protection are present in the small motors that are ubiquitous in today's automobiles. Particularly popular on the market have been Nichicon's positive thermistors for in-vehicle supplemental heaters and case-type positive thermistors for in-rush current limitations. Thanks to their solid performance, these products have received zero complaints from users and have helped Nichicon form a strong bond of trust with customers.

Used in an increasing number of fields, these positive thermistors are used in; automobiles, air conditioners, lighting products, and office equipment. Discover for yourself the practically unlimited possibilities of Nichicon's Posi-R positive thermistors.

Positive Thermistors "Posi-R"

Curie temperature
50° to 240°C

for
Heater

This type thermistor heats up quickly and evenly until reaching the desired temperature.

One of the main types of thermistors, those used for heaters, has a proven track record in in-vehicle supplemental heaters.

[How it works]

Thermistors for heaters require safety and power saving performance. The Posi-R quickly heats up when current flows through it. The Posi-R reaches the heating temperature evenly throughout its entire structure. The heating temperature can be controlled by adjusting the construction of Posi-R's material make-up. In addition, because Posi-R maintains a constant temperature thanks to a balance between heat generation and heat dissipation, it will not exceed the heating temperature.

[Record on the market]

Posi-R has a proven track record for in-vehicle applications, a field where reliability is of the utmost importance. It is widely used as the heat-generating element in supplemental heaters used in hybrid vehicles and other eco-cars.

[Features]

- Quickly heats up to desired temperature.
- Its temperature is uniform and never gets red hot, making it very safe.
- Posi-R's self-temperature-control effect prevents excessive heating.
- The Posi-R's self-temperature-control function ensures power savings.
- Users can select their desired temperatures.

Applications

- In-vehicle supplemental heaters
- Facial massage heaters
- Condensation-prevention heaters for office equipment
- Clothes drying heaters
- Defrost heaters for refrigerators

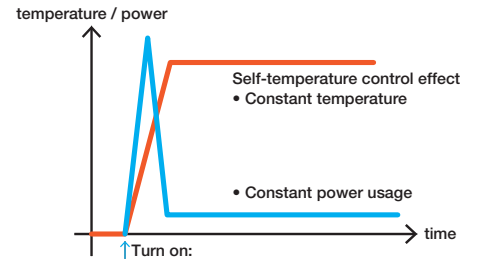

Temperature quickly rises, and temperature and power usage are constant.

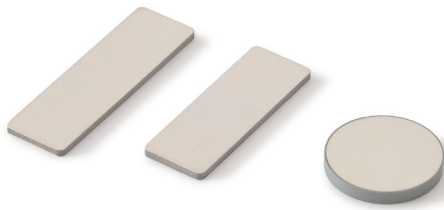

Specifications

- **Rated Voltage : 12 to 220V**
- **Resistance : 0.5 to 2kΩ**
Resistance value changes at rated voltage

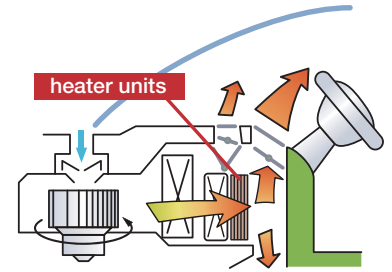

[Thermistor for in-vehicle heater]
Posi-R is used as the heat generating element in heater units.

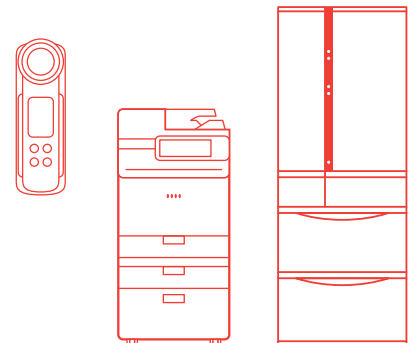
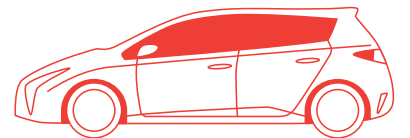

Positive Thermistors "Posi-R"

Stability and safety maintained even under abnormal conditions.

for
In Rush
Current Limitation,
General Use



Specifications

- **Rated Voltage : 100 to 240V**
- **Resistance : 15 to 100Ω**
Resistance value changes at rated voltage

Case type and lead type Superior to the competition in durability and space efficiency

Highly durable case type Space-efficient lead type Two types for in-rush current limitation

[How they work]

In-rush current limitation requires a high level of reliability. In these applications, the Posi-R is used in switch parts and parallel connection. When the power circuit is turned on and in-rush current is applied to the Posi-R, this current is quickly contained, thus protecting the secondary electronic equipment. Even during irregularities of continuous application of voltage, the Posi-R provides stability and safety by ensuring a constant temperature.

[Record on the market]

Posi-R is used in lighting product power circuits, which are frequently turned on and off. Posi-R has one of the highest shares* in the Japanese market for thermistors for air conditioner power circuits.

* As of April 2017; according to Nichicon

[Features]

- Unlike cement resistors, these thermistors will not melt or short even when voltage is continuously applied after a switch part breaks down.
- Space efficient
- Because the thermistors have recovery properties, they can withstand continuous use.

Applications

- Indoor and outdoor units for commercial air conditioners
- Indoor and outdoor units for room air conditioners
- Lighting products for offices
- EcoCute systems
- Switching power supplies

[Voltage application time and product temperature]

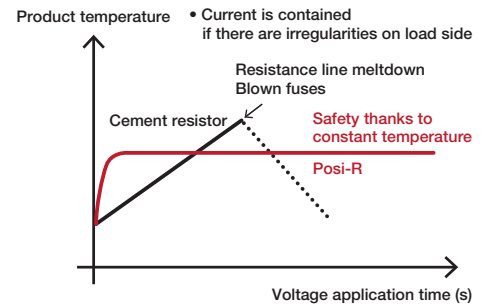

Compared to cement resistors, will not rise in temperature even under continuous current flow.

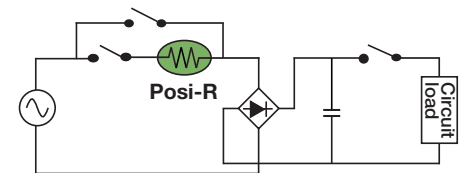

[Example of circuits used in]

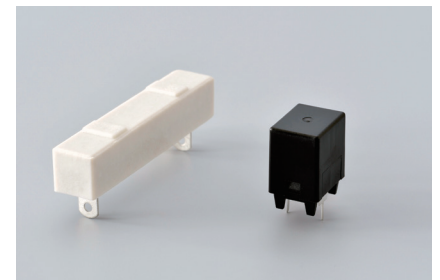

More space efficient than cement resistors

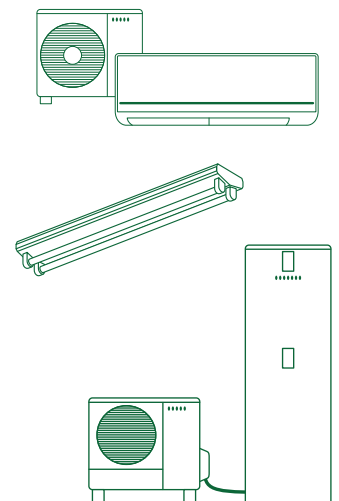

Low specific resistance means wider current range

for
Overcurrent
Protection

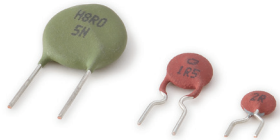

Specifications

- ⦿ **Rated Voltage : 12 to 220V**
- ⦿ **Resistance : 0.3 to 1kΩ**
Resistance value changes at rated voltage

Hard at work in small automobile motors, positive thermistors bring comfort to passengers.

Protects the motors in door locks, power windows and other small motors used in automotive applications.

[How it works]

The Posi-R for overcurrent protection must be able to withstand repeated operation. The Posi-R controls the element and thus contains the current. As a result the current can be contained repeatedly after the current value returns to normal. The Posi-R is thus superior to fuses and polymer-based PTC's. A fuse will "blow" when exposed to irregular current and is no longer useful. Polymer-based PTC, will change usage conditions the more it is used.

[Record on the market]

Posi-R is mainly used to protect small motors for in-vehicle applications (door mirrors, door locks, etc.), where products must withstand repeated use; and in air conditioner circuits (inverter control circuit boards, outdoor unit fan motors, etc.).

[Features]

- Ability to withstand repeated use means there's no need to replace it like with fuses.
- Offers superior repeated use since it's non contact.
- Usage conditions won't change even after repeated usage.
- No faulty operation due to noise.

Applications

- Door locks
- Door mirrors
- Vacuum cleaner power brushes
- Telephones
- Air conditioners
- Car audio systems

[Current-Time properties]

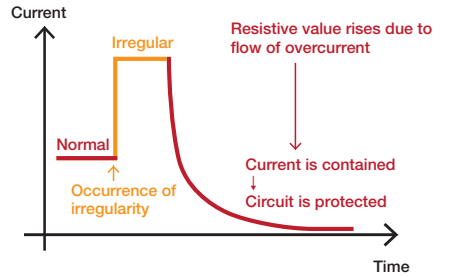

Current is contained in case of irregularity and circuit is thus protected.

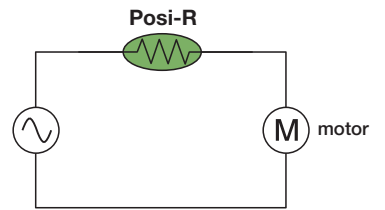

[Example of circuits used in]

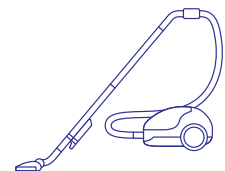
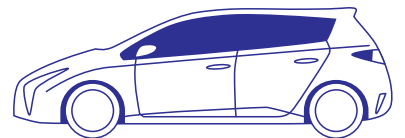

NICHICON (KAMEOKA) CORPORATION

15-1, 2-chome, Kitakose-cho, Kameoka-shi, Kyoto Pref., 621-0811 Japan
TEL.81-771-22-5541 FAX.81-771-29-2010

Product line : Positive thermistors "Posi-R",
Function modules, Various types of power supplies
ISO 9001 & ISO 14001 certified

NICHICON CORPORATION <http://cn-nichicon.com/>

HEAD OFFICE

Karasumadori Oike-agaru, Nakagyo-ku, Kyoto, 604-0845 Japan
TEL.81-75-231-8461 FAX.81-75-256-4158

TOKYO SALES OFFICE

14-9, Nihonbashi Kabuto-cho, Chuo-ku, Tokyo, 103-0026 Japan
TEL.81-3-3666-7811 FAX.81-3-3666-7831

NAGOYA SALES OFFICE

18F, Nishiki-Park Bldg.
4-3, Nishiki 2-chome, Naka-ku, Nagoya, 460-0003 Japan
TEL.81-52-223-5581 FAX.81-52-220-1839

WEST JAPAN SALES OFFICE

Karasumadori Oike-agaru, Nakagyo-ku, Kyoto, 604-0845 Japan
TEL.81-75-241-5370 FAX.81-75-231-8467

NICHICON (SINGAPORE) PTE. LTD.

20 Jalan Afifi, #06-08, Certis CISCO Centre II,
Singapore 409179
TEL.65-6481-5641 FAX.65-6481-6485

NICHICON (TAIWAN) CO., LTD.

23F, No.68, Sec.5, Zhongxiao East Road, Xinyi District, Taipei City 110, Taiwan, R.O.C.
TEL.886-2-2722-2100 FAX.886-2-2722-2016

NICHICON (THAILAND) CO., LTD.

1 Empire Tower, 15th Floor, Unit 1506, River Wing West,
South Sathorn Road, Yannawa, Sathorn, Bangkok 10120 Thailand
TEL.66-2-670-0150 FAX.66-2-670-0153

NICHICON ELECTRONICS TRADING (SHANGHAI) CO., LTD.

Room 1206, Aetna Tower, 107 Zunyi Road, Shanghai, China 200051
TEL.86-21-6237-5538 FAX.86-21-6237-5537

• DALIAN REPRESENTATIVE OFFICE

12F Senmao Building, 147 Zhongshan Road, Xigang District, Dalian, China 116011
TEL.86-411-3989-3322 FAX.86-411-3989-3168

NICHICON ELECTRONICS TRADING (SHENZHEN) CO., LTD.

Room A, 16/F, KK100
No. 5016, Shen Nan Road East, Luo Hu District, Shenzhen, China 518001
TEL.86-755-2294-1800 FAX.86-755-8294-5716

• CHONGQING BRANCH

Room 2812, 28/F, International Trade Center (Part A), No.38, Qing Nian Road,
Yuzhong District, Chongqing, China 400010
TEL.86-23-6310-8166 FAX.86-23-6310-8308

• CHENGDU BRANCH

Room 1408, 14/F, Hailun Complex (Part A), No.216, Xi Dong Da Street, Jinjiang District,
Chengdu, Sichuan, China 610021
TEL.86-28-6212-9507 FAX.86-28-6212-9513

NICHICON ELECTRONICS (INDIA) PVT. LTD.

Unit No.906, 9th Floor, Prestige Meridian-1, No.29 M.G. Road,
Bengaluru 560001, Karnataka, India
TEL.91-80-4094-8661 FAX.91-80-4094-8651

• DELHI OFFICE

Level 2, Elegance Tower, Mathura Road, Jasola, New Delhi 110025, India
TEL.91-11-6635-1223 FAX.91-11-6635-1235

• MUMBAI OFFICE

Unit 1, Level 2, B Wing, Times Square, Andheri Kurla Road, Andheri East,
Mumbai 400059, India
TEL.91-22-6608-9523 FAX.91-22-6608-9696

NICHICON CORPORATION KOREA REPRESENTATIVE OFFICE

B-1322, Heungdeok IT Valley, 13, Heungdeok1-ro, Giheung-gu, Yongin-si,
Gyeonggi-do, 446-908, Korea
TEL.82-31-8065-6366 FAX.82-31-8065-6367

NICHICON (MALAYSIA) SDN. BHD.

No.4 Jalan P/10, Kawasan Perusahaan Bangi,
43650 Bandar Baru Bangi, Selangor Darul Ehsan, Malaysia
TEL.60-3-8925-0678 FAX.60-3-8925-0858

NICHICON ELECTRONICS (WUXI) CO., LTD.

Block 51-B, Wuxi National High & New Technology Industrial
Development Zone, Wuxi, Jiangsu, China 214028
TEL.86-510-8521-8222 FAX.86-510-8522-1170

NICHICON ELECTRONICS (SUQIAN) CO., LTD.

No.18, Yangmingshan Avenue, Suzhou Suqian Industrial Park, Suqian, China 223800
TEL.86-527-8097-8855 FAX.86-527-8286-8966

NICHICON (AMERICA) CORP.

927 East State Parkway, Schaumburg, Illinois 60173, U.S.A.
TEL.1-847-843-7500 FAX.1-847-843-2798

NICHICON (AUSTRIA) GmbH

Businesspark Marximum, Modecenterstrasse 17, Unit 2-7-A,
1110 Vienna, Austria
TEL.43-1-706-7932 FAX.43-1-706-7933

• U.K.OFFICE

4.3 Frimley Business Park, 1A Frimley,
Camberley, Surrey GU16 7SG, United Kingdom
TEL.44-1276-405500 FAX.44-1276-686531

NICHICON (HONG KONG) LTD.

Unit 308, Harbour Centre Tower 1, 1 Hok Cheung Street,
Hung Hom, Kowloon, Hong Kong
TEL.852-2363-4331 FAX.852-2764-1867



CAUTION FOR SAFETY

- TO USE NICHICON PRODUCT CORRECTLY AND SAFETY, PLEASE READ "APPLICATION GUIDELINES" VERY CAREFULLY.
- THE PRODUCTS DESCRIBED IN THIS CATALOG WERE DESIGNED AND MANUFACTURED MAINLY FOR GENERAL ELECTRONIC APPLICATIONS. IF YOU PLAN TO USE OUR PRODUCTS IN APPLICATIONS SUCH AS MEDICAL, TRAFFIC AND TRANSPORT, AEROSPACE AND AIRCRAFT, POWER GENERATION CONTROL, SAFETY AND SECURITY, OR OTHER SPECIAL APPLICATIONS THAT REQUIRE EXTREME HIGH QUALITY, HIGH RELIABILITY AND SAFETY, OR IF THE FAILURE OR MALFUNCTION OF THE PRODUCTS COULD DIRECTLY JEOPARDIZE OR INJURE LIFE, AND/OR DAMAGE PROPERTY, PLEASE USE ONLY AFTER YOU HAVE SUFFICIENTLY TESTED THE PRODUCTS TO ASSURE SUITABILITY FOR THE PARTICULAR APPLICATION.
- PRIOR TO ORDERING A PRODUCT, PLEASE OBTAIN A COPY OF SPECIFICATION FROM NICHICON AND USE THE SPECIFICATION AS A BASIS WHEN DESIGNING EQUIPMENT AND INCORPORATING OUR PRODUCT. NICHICON ADMITS NO LIABILITY FOR EQUIPMENT PROBLEMS DUE TO THE LACK OF PRODUCT SPECIFICATIONS BEING CONFIRMED. ALSO, PLEASE BE SURE TO PERFORM ALL NECESSARY UNIT LEVEL EVALUATION TESTING TO AVOID MALFUNCTIONS THAT COULD BE UNFORESEEABLE DURING COMPONENT LEVEL TESTING ALONE.

- NOTE :
- SPECIFICATION AND DIMENSIONS IN THIS CATALOG ARE SUBJECT TO CHANGE WITHOUT NOTICE. IF NECESSARY, DRAWINGS CAN BE PROVIDED.
 - IN CASE THAT THERE IS A CERTAIN DANGER OF THE PRODUCTS CONFLICTING WITH THE USE AND ACTIVITY FOR THE DEVELOPMENTS OF WEAPONS OF MASS DESTRUCTION, THE PROCEDURES BASED UPON THE RELEVANT EXPORT REGULATION LAWS ARE ABSOLUTELY NEEDED.
 - THE PRODUCTS AND THEIR PACKAGES DO NOT CONTAIN ANY OZONE DEPLETING SUBSTANCES (ODS) UNDER THE MONTREAL PROTOCOL. AND ODS IN NOT USED IN THEIR MANUFACTURING PROCESSES, TOO.
 - THE CONTENTS DESCRIBED IN THIS CATALOG SHOULD ONLY BE APPLIED TO PRODUCTS PURCHASED DIRECTLY FROM A NICHICON SALES OFFICE OR FROM AN AUTHORIZED NICHICON DISTRIBUTOR.
 - OTHER THAN THE EXPRESS WRITTEN SPECIFICATIONS CONTAINED IN NICHICON'S CATALOG OR OTHER NICHICON LITERATURE. NICHICON MAKES NO WARRANTY, EXPRESS, IMPLIED, OR OTHERWISE, IN CONNECTION WITH THESE PRODUCTS, AND ALL IMPLIED WARRANTIES, INCLUDING THE WARRANTY OF MERCHANTABILITY AND FITNESS FOR A PARTICULAR PRODUCT, ARE DISCLAIMED. NICHICON SHALL NOT BE LIABLE FOR INCIDENTAL OR CONSEQUENTIAL DAMAGES. CUSTOMER'S SOLE REMEDY IN THE EVENT THAT NICHICON'S SPECIFICATIONS ARE NOT MET IS TO REPAIR, REPLACE, OR REFUND THE PURCHASE PRICE OF THE SUBJECT PRODUCT, AT NICHICON'S OPTION.
 - CATALOG PRINTED IN JAN. 5, 2018